



## South Bay Odor Attribution Study

### Final Report

230407112709\_08bfbc6e

### Bay Area Air Quality Management District

#### Document history and status

Revision	Date	Description	Authors	Checked	Reviewed	Approved
0	12/07/2021	Draft Final	NR/BK/SC	SC/BK/ML	SC/BK/ML	ML
1	06/30/2022	Final	AX/SC	SC/ML	ML	ML
2	04/03/2023	Final Final	SC	SC	SC	SC
3	08/15/2023	Final Final Final	SC	SC	SC	SC

#### Distribution of copies

Revision	Issue approved	Date issued	Issued to	Comments
0	ML	12/07/2021	BAAQMD	For client review
1	ML	06/30/2021	BAAQMD	Final Report
2	SC	04/03/2023	BAAQMD	Final Final Report
3	SC	08/15/2023	BAAQMD	Final Final Final Report

---

## South Bay Odor Attribution Study

Project No: W8Y05600  
Document Title: South Bay Odor Attribution Study  
Document No.: 230407112709\_08bfbc6e  
Revision: rev 3  
Document Status: Final Final Final  
Date: August 15, 2023  
Client Name: Bay Area Air Quality Management District

Jacobs Engineering Group Inc.

4 Embarcadero Center  
Suite 3800  
San Francisco, CA 94111  
United States  
T +1.415.356.2040  
F +1.415.356.2055  
[www.jacobs.com](http://www.jacobs.com)

© Copyright 2023 Jacobs Engineering Group Inc. The concepts and information contained in this document are the property of Jacobs. Use or copying of this document in whole or in part without the written permission of Jacobs constitutes an infringement of copyright.

Limitation: This document has been prepared on behalf of, and for the exclusive use of Jacobs' client, and is subject to, and issued in accordance with, the provisions of the contract between Jacobs and the client. Jacobs accepts no liability or responsibility whatsoever for, or in respect of, any use of, or reliance upon, this document by any third party.

# Contents

- Acronyms and Abbreviations..... vii**
- Executive Summary..... ix**
- 1. Introduction and Background ..... 1-1**
- 2. Description of Key Facility Processes ..... 2-1**
  - 2.1 Newby Island Resource Recovery Park..... 2-3
  - 2.2 San José-Santa Clara Regional Wastewater Facility ..... 2-5
  - 2.3 Zero Waste Energy Development Facility ..... 2-6
- 3. Chemical Compound and Odor Assessments..... 3-1**
  - 3.1 Field Sampling Program..... 3-1
    - 3.1.1 Approach and Methodology..... 3-1
    - 3.1.2 Field Sample Collection ..... 3-2
    - 3.1.3 Flux Chamber Sampling (for area sources – liquid and solid surfaces) ..... 3-4
    - 3.1.4 Laboratory Analytical Methods..... 3-6
    - 3.1.5 Field Surveys/Measurements..... 3-12
  - 3.2 Sampling Event Summary ..... 3-14
    - 3.2.1 Sampling Event 1 – Fall 2020 ..... 3-14
    - 3.2.2 Sampling Event 2 – Winter 2020/21 ..... 3-41
    - 3.2.3 Sampling Event 3 – Spring 2021 ..... 3-46
    - 3.2.4 Sampling Event 4 – Summer 2021 ..... 3-65
  - 3.3 Summary of Sampling Events Conducted by Others ..... 3-72
    - 3.3.1 City of Milpitas Community Impact Study..... 3-72
    - 3.3.2 Montrose PTR-MS “Fingerprinting” Study ..... 3-78
  - 3.4 Odor Sampling Program Summary and Conclusions..... 3-86
- 4. Evaluation of Odor Monitoring Techniques ..... 4-1**
  - 4.1 Overview of Odor Monitoring Techniques..... 4-1
    - 4.1.1 Olfactometry Methods..... 4-2
    - 4.1.2 Chromatography Chemical Analyses Methods ..... 4-2
    - 4.1.3 Chemical Sensors ..... 4-3
    - 4.1.4 Multi-Sensor Devices..... 4-4
    - 4.1.5 Proton Transfer Reaction Mass Transfer ..... 4-5
  - 4.2 Odor Monitoring Requirements..... 4-6
  - 4.3 Evaluation Criteria and Conclusions..... 4-6
- 5. Strategy Development for Ongoing Odor Measurement ..... 5-1**
  - 5.1 Purpose and the Requirements of the Strategy ..... 5-1
  - 5.2 Main Components of an Ongoing Odor Measurement System ..... 5-2
  - 5.3 Layout of the Ongoing Odor Measuring System..... 5-3
  - 5.4 Ongoing Community Odor Monitoring ..... 5-5
  - 5.5 Concept Approach..... 5-6
- 6. Findings and Recommendations ..... 6-1**
- 7. References..... 7-1**

**Appendixes**

- A Sampling and Odor Survey Plan
- B Laboratory Results
- C Example Quote of a Facility Ongoing Odor Monitoring System
- D Example of Community Odor Bag Sampling Device
- E Sample Event Field Photos
- F Parts Per Billion to Mass Loading Conversion Summary

**Tables**

- ES-1 Source Recommended Abatement Solutions .....xvi
- 3-1 Summary of Targeted Sampled Odorant and Protocols..... 3-6
- 3-2 Analytical Methods and Reporting Limits ..... 3-8
- 3-3 List of Sub-compounds for Selected Tests ..... 3-10
- 3-4 List of 61 Standard VOCs Using EPA Method TO-17..... 3-11
- 3-5 Sampling Matrix for Sampling Event 1..... 3-15
- 3-6 Sampling Event 1 Reduced Sulfur Compound Analytical Results ..... 3-17
- 3-7 Sampling Event 1 General Odor Laboratory Results ..... 3-18
- 3-8 Sampling Event 1 Aldehyde Analytical Results..... 3-22
- 3-9 Sampling Event 1 Carboxylic Acid Analytical Results ..... 3-22
- 3-10 Sampling Event 1 Amine Analytical Results..... 3-23
- 3-11 Sampling Event 1 Ammonia Analytical Results ..... 3-24
- 3-12 Sampling Event 1 VOC Analytical Results (1 of 7)..... 3-24
- 3-13 Sampling Event 1 VOC Analytical Results (2 of 7)..... 3-25
- 3-14 Sampling Event 1 VOC Analytical Results (3 of 7)..... 3-26
- 3-15 Sampling Event 1 VOC Analytical Results (4 of 7)..... 3-26
- 3-16 Sampling Event 1 VOC Analytical Results (5 of 7)..... 3-27
- 3-17 Sampling Event 1 VOC Analytical Results (6 of 7)..... 3-28
- 3-18 Sampling Event 1 VOC Analytical Results (7 of 7)..... 3-28
- 3-19 Sampling Event 1 OPM Intensity Values..... 3-29
- 3-20 Sampling Event 2 Sampling Matrix ..... 3-42
- 3-21 Sampling Event 2 General Odor Laboratory Results ..... 3-43
- 3-22 Sampling Event 2 General Odor Laboratory Results ..... 3-43
- 3-23 Sampling Event 3 Matrix ..... 3-47
- 3-24 Reduced Sulfur Compound Analytical Results ..... 3-49
- 3-25 Odor Panel Analysis Results..... 3-49
- 3-26 Aldehyde Analytical Results..... 3-51
- 3-27 VOC Analytical Results (1 of 7)..... 3-52
- 3-28 VOC Analytical Results (2 of 7)..... 3-52
- 3-29 VOC Analytical Results (3 of 7)..... 3-53
- 3-30 VOC Analytical Results (4 of 7)..... 3-53
- 3-31 VOC Analytical Results (5 of 7)..... 3-54
- 3-32 VOC Analytical Results (6 of 7)..... 3-54
- 3-33 VOC Analytical Results (7 of 7)..... 3-55
- 3-34 Results Odor Characterization by OPM for Sampling Event 3..... 3-55
- 3-35 Sampling Event 4 Matrix ..... 3-66
- 3-36 Odor Panel Analysis Results for Sampling Event 4 ..... 3-67
- 3-37 OPM Odor Characterization Results for Sampling Event 4..... 3-69
- 3-38 Results Field Odor Assessments Frequency of Odors Observed ..... 3-72

3-39	Results of Field Odor Assessments -- Odor Intensity Observed during 50 Surveys .....	3-73
3-40	Results of Field Odor Assessments - Hedonic Tone of Odors Observed .....	3-74
3-41	Results Field Odor Assessments - Odor Strength of Odors Observed.....	3-75
3-42	Summary of Bag Sampling in Support of Montrose Study.....	3-79
4-1	Classification of Typical Chemical Gas Sensors .....	4-4
4-2	Summary of High-Level Multiple Criteria Analyses Different Odorous Compounds Measuring Methods .....	4-8
6-1	Summary of Odor Abatement Recommendations.....	6-3
B-1	Odor Characteristics and Intensities of Each Odor Characteristic Observed .....	B-1
B-2	Field Odor Measurements at and around ZWED, October 19, 2020.....	B-3
B-3	Field Odor Measurements at and around RWF, October 20, 2020 .....	B-6
B-4	Field Odor Measurements at and around Newby, October 21, 2020.....	B-9
B-5	Field Odor Measurements at and around RWF, October 22, 2020 .....	B-12
B-6	PTR-MS Analysis of ZWED Interior Space Sample.....	B-13
B-7	PTR-MS Analysis of RWF Primary Clarifier Sample .....	B-18
B-8	PTR-MS Analysis of Newby Composting Pile Sample .....	B-21
B-9	Results of Field Odor Measurements on Monday 17 May 2021 (Sampling Event 3).....	B-27
B-10	Results of Field Odor Measurements on Tuesday 18 May 2021 (Sampling Event 3). .....	B-28
B-11	Results of Field Odor Measurements on Wednesday May 19, 2021 (Sampling Event 3).....	B-29
B-12	Results of Field Odor Measurements on Thursday May 20, 2021 (Sampling Event 3).....	B-30

**Figures**

ES-1	Key Odor-Emitting Facilities, Sources, and Surrounding Communities .....	x
ES-2	Sampling Event 1 OAV Comparison for ZWED .....	xi
ES-3	Sampling Event 1 OAV Comparison for RWF .....	xii
ES-4	Sampling Event 1 OAV Comparison for NIRRP.....	xii
ES-5	Sampling Event 3 OAV Comparison for ZWED .....	xiii
ES-6	Sampling Event 3 OAV Comparison for RWF .....	xiii
ES-7	Sampling Event 3 OAV Comparison for NIRRP.....	xiv
ES-8	Visual Representation of Most Likely Origination of Odors Observed in the Community (Milpitas Community Impact Study) .....	xv
2-1	Key Odor-Emitting Facilities and Surrounding Communities.....	2-1
2-2	Waste Stream Transfers Between Facilities .....	2-2
2-3	Newby Island Resource Recovery Park Facility Map, Milpitas, California .....	2-4
2-4	San José-Santa Clara RWF Overview .....	2-5
2-5	ZWED Facility Overview.....	2-6
2-6	ZWED Basic Process Steps .....	2-7
3-1	EPA Flux Chamber with Sampling Equipment.....	3-4
3-2	Sorbent Tubes and Sampling Pumps.....	3-5
3-3	Weber-Fechner Curves for Various Odorous Constituents .....	3-9
3-4	Odor Descriptors for ZWED Interior .....	3-19
3-5	Odor Descriptors for ZWED Biofilter 1 .....	3-19
3-6	ZWED Activated Carbon Filter .....	3-20
3-7	RWF Bioreactors .....	3-20
3-8	Odor Descriptors for RWF Lagoons.....	3-20
3-9	Odor Descriptors for RWF Drying Beds.....	3-20
3-10	Odor Descriptors for NIRRP Landfill Working Face .....	3-21
3-11	Odor Descriptors for NIRRP Compost Piles.....	3-21

3-12	Odor Descriptors for NIRRP MRF .....	3-21
3-13	Odor Descriptors for NIRRP Cake Stockpile.....	3-21
3-14	ZWED Biofilter OPM Persistency Curves.....	3-31
3-15	ZWED Interior Space OPM Persistency Curves.....	3-31
3-16	ZWED Upwind OPM Persistency Curves .....	3-32
3-17	RWF Primary Effluent OPM Persistency Curves .....	3-32
3-18	RWF Aeration Basin OPM Persistency Curves.....	3-33
3-19	NIRRP Compost Pile OPM Persistency Curves .....	3-33
3-20	NIRRP Landfill Working Face OPM Persistency Curves.....	3-34
3-21	NIRRP Landfill Gas OPM Persistency Curves .....	3-34
3-22	NIRRP Landfill Leachate OPM Persistency Curves.....	3-35
3-23	ZWED Downwind OPM Persistency Curves.....	3-35
3-24	Sampling Event 1 OAV Comparison for ZWED .....	3-36
3-25	Sampling Event 1 OAV Comparison for RWF .....	3-37
3-26	Sampling Event 1 OAV Comparison for NIRRP .....	3-37
3-27	Sampling Event 1 H <sub>2</sub> S Continuous Monitoring Results for ZWED Interior Space.....	3-38
3-28	Sampling Event 1 H <sub>2</sub> S Continuous Monitoring Results for ZWED Activated Carbon Filter .....	3-39
3-29	Sampling Event 1 H <sub>2</sub> S Continuous Monitoring Results for RWF Primary Clarifier Effluent Launder/Box .....	3-39
3-30	Field Odor Assessment Locations .....	3-40
3-31	Odor Descriptors for ZWED Interior .....	3-44
3-32	Odor Descriptors for NIRRP Working Face .....	3-44
3-33	Odor Descriptors for ZWED Biofilter.....	3-45
3-34	Odor Descriptors for Downwind Sample.....	3-45
3-35	Odor Descriptors for Upwind .....	3-45
3-36	Odor Descriptors for ZWED Interior .....	3-50
3-37	Odor Descriptors for RWF Bioreactor .....	3-50
3-38	Odor Descriptors for NIRRP Compost Pile.....	3-51
3-39	ZWED Biofilter OPM Persistency Curves.....	3-57
3-40	ZWED Interior OPM Persistency Curves.....	3-57
3-41	ZWED Upwind OPM Persistency Curves .....	3-58
3-42	ZWED Downwind OPM Persistency Curves.....	3-58
3-43	Bioreactor Mixing Zone OPM Persistency Curves .....	3-59
3-44	East Primaries OPM Persistency Curves .....	3-59
3-45	Landfill Working Face OPM Persistency Curves.....	3-60
3-46	Compost Pile OPM Persistency Curves .....	3-60
3-47	Landfill Gas OPM Persistency Curves .....	3-61
3-48	Sampling Event 3 OAV Comparison for ZWED .....	3-62
3-49	Sampling Event 3 OAV Comparison for RWF .....	3-62
3-50	Sampling Event 3 OAV Comparison for NIRRP.....	3-63
3-51	Sampling Event 3 H <sub>2</sub> S Continuous Monitoring Results for ZWED Biofilter and Interior Space .....	3-64
3-52	Sampling Event 3 H <sub>2</sub> S Continuous Monitoring Results for RWF Bioreactor, Primary Clarifier, and Estuary .....	3-64
3-53	Odor Descriptors for Lagoons.....	3-68
3-54	Odor Descriptors for Compost Piles.....	3-68
3-55	Odor Descriptors for Biosolids Stockpile .....	3-68
3-56	Odor Descriptors for CASP Contact Water Pond .....	3-68
3-57	NIRRP Compost Pile OPM Persistency Curves .....	3-70
3-58	RWF Lagoons OPM Persistency Curves .....	3-70
3-59	Upwind/Bay OPM Persistency Curves.....	3-71
3-60	NIRRP Stormwater Pond OPM Persistency Curves .....	3-71

---

3-61	Frequency and Descriptors of Odor Observed Directly Downwind of Main Odor-Emitting Facilities (Milpitas Community Impact Study).....	3-76
3-62	Visual Representation of Most Likely Origination of Odors Observed in the Community (Milpitas Community Impact Study).....	3-77
3-63	PTR-MS Illustration.....	3-79
3-64	Chemical Fingerprint of the Air Upwind of the Main Odor-Emitting Facilities.....	3-81
3-65	Chemical Fingerprint of the Air Inside the ZWED Facility.....	3-82
3-66	Chemical Fingerprint of the Air Emitted from a Biofilter at the ZWED Facility.....	3-82
3-67	Chemical Fingerprint of the Air Emitted from a Primary Clarifier at the RWF Facility.....	3-82
3-68	Chemical Fingerprint of the Air Emitted from a Bioreactor at the RWF Facility.....	3-83
3-69	Chemical Fingerprint of the Air Downstream of the Lagoons at the RWF Facility.....	3-83
3-70	Chemical Fingerprint of the Air Downwind of the Landfill at the NIRRP Facility.....	3-83
3-71	Chemical Fingerprint of the Air Emitted from a Compost Pile at the NIRRP Facility.....	3-84
3-72	Chemical Fingerprint of the Air Inside the MRF at the NIRRP Facility.....	3-84
3-73	Chemical Fingerprint of the Landfill Gas at the NIRRP Facility.....	3-84
3-74	PCA Differentiation Between Bag Samples (Source: Montrose).....	3-85
3-75	Comparison of PCA Results of Multiple Bags.....	3-86
5-1	Example of Continuous Odor Monitoring System Schematic.....	5-3
5-2	Recommended Positioning of Ongoing Odor Measuring System for Main Source Facilities.....	5-4

## Acronyms and Abbreviations

°F	degree(s) Fahrenheit
µg/m <sup>3</sup>	microgram(s) per cubic meter
AD	anerobic digestion
ALS	ALS Environmental Laboratories
ANSI	American National Standards Institute
ASP	aerated static pile
BAAQMD	Bay Area Air Quality Management District
BLOB	binary large object
CASP	covered aerated static pile
D/T	detection to threshold
EPA	U.S. Environmental Protection Agency
GC	gas chromatography
GPS	geographic positioning system
HT	hedonic tone
IOMS	instrumental odor monitoring system
IVC	in-vessel composter
Jacobs	Jacobs Engineering Group Inc.
L	liter(s)
L/min	liter(s) per minute
mgd	million gallon(s) per day
mL	milliliter(s)
Montrose	Montrose Environmental Group
MRF	material recovery facility
MS	mass spectrometry
MVA	multivariate analysis
NIRRP	Newby Island Resource Recovery Park
NISL	Newby Island Landfill
OAV	odor activity value
OPM	Odor Profile Method
OSHA	Occupational Safety and Health Act
OTC	odor threshold concentration
PCA	principal component analysis
ppb	part(s) per billion



---

ppbv	part(s) per billion by volume
ppm	part(s) per million
ppmv	part(s) per million by volume
ppt	part(s) per trillion
PRV	pressure relief valve
PTR	proton transfer reaction
PTR-MS	proton transfer reaction mass spectrometry
RWF	Regional Wastewater Facility
SCAQMD	South Coast Air Quality Management District
Study	South Bay Odor Attribution Study
TMA	trimethyl amine
TOF	time of flight
TRS	total reduced sulfur
UCLA	University of California-Los Angeles
VOC	volatile organic compound
ZWED	Zero Waste Energy Development

## Executive Summary

Jacobs Engineering Group Inc. (Jacobs) was engaged by the Bay Area Air Quality Management District (BAAQMD) to undertake this South Bay Odor Attribution Study (Study). This Study was conducted in parallel with and complementary to a related study undertaken by Montrose Environmental Group (Montrose).

This Final Report documents the comprehensive analysis work conducted by Jacobs to identify unique odor-causing compounds from three closely located facilities in San José, California, near the City of Milpitas. These facilities include the following:

- Newby Island Resource Recovery Park (NIRRP) landfill and associated composting and materials recovery facilities (MRF)
- San José-Santa Clara Regional Wastewater Facility (RWF)
- Zero Waste Energy Development (ZWED) dry anaerobic food waste digester facility

In addition, potential impacts from San Francisco Bay, the nearby City of Milpitas lift station, and a Bay estuary culvert were evaluated as part of the study.

The main objectives of the Study included attributing unique odor-causing compounds from three closely located facilities, determining odorous compound variability over time, identifying specific sources that emit “fingerprint” odorous compounds, and developing methods to monitor and quantify identified compounds that cross a given facility’s fence line.

A total of four sampling events were conducted to gather data from specific sources and ambient locations to better understand odor impacts within the local South Bay communities of Milpitas, San José, and Fremont, California (Figure ES-1). The four sampling events are summarized as follows:

Sampling Event	Season Conducted	Description/Purpose
1	Fall 2020	A screening sampling activity to identify the primary nuisance odor characters present at each facility and quantify odor concentrations and intensities.
2	Winter 2020/21	A smaller scale event focused on validating results from Sampling Event 1.
3	Spring 2021	A comprehensive sampling event similar in scope to Sampling Event 1. Coincided with Montrose’s field activities to enable correlation of results between the two studies.
4	Summer 2021	A smaller scale event focused on validating results, similar to Sampling Event 2.

Air samples were analyzed utilizing BAAQMD and federally approved methods, analyses, and protocols. Collection methods included U.S. Environmental Protection Agency (EPA) approved flux hoods, vacuum chambers, sorption tubes – compliant volumetric flows, and continuous H<sub>2</sub>S monitoring.



Figure ES-1. Key Odor-Emitting Facilities, Sources, and Surrounding Communities

Analytical test methods employed included the following:

- Sulfur: ASTM D5504 (ALS Environmental Laboratories [ALS])
- Ammonia and Amines: Sorption tubes (ALS)
- Aldehydes: EPA Method TO-11A, sorption tubes (ALS)
- Carboxylic Acids (VFAs): Sorption tubes (ALS)
- Volatile Organic Compounds (VOCs): EPA Method TO-17 (ALS)
- Odor Concentration (Detection to Threshold): ASTM E679 and EN13725 (St. Croix Sensory)
- Odor Profile Method (UCLA)

Field survey efforts were conducted utilizing a field olfactometer (Scentroid SM100) for measuring the following:

- Detection to Threshold (D/T)
- Odor Character (i.e., what it smells like)
- Odor Intensity (i.e., the strength of the odor)
- Hedonic Tone (i.e., the offensiveness of the odor)

Odor characterization from the four sample events revealed the following key “fingerprint” odorant groupings associated with key facilities:

- San José RWF: Mostly sulfur (H<sub>2</sub>S and methyl mercaptan) and fecal.
- ZWED: Sweet (aldehydes) and rancid (VFAs) with musty.
- NIRRP: Rancid (VFAs) and sweet (aldehydes) with garbage. Landfill gas mostly sulfur (H<sub>2</sub>S) and fecal.

Odor Profile Method (OPM) persistency curves revealed which odors persist as a function of dilution (i.e., distance away from the source). This is called the “peeling the onion” effect. In almost all cases, musty odorants were most persistent.

The results of laboratory analytical work, field survey work, and UCLA (OPM) laboratory work generally agreed for each of the four sampling events. Each event provided confirmation of previous “fingerprint” odorants pertaining to specific sources.

Odor activity values (OAVs) provide an excellent method for identifying the most relevant odors of concern from a nuisance odor standpoint. OAVs quantify odor potency/importance in terms of the ratio of measured concentration of an odorant to its odor threshold concentration (OTC). Figure 3-24 through Figure 3-26 provide a comparison of OAVs for all measured sources at ZWED, RWF, and NIRRP, respectively, for Sample Event 1 (Fall 2020). Figure ES-5 through ES-7 provide a comparison of OAVs for Sample Event 2 (Spring 2021). An OAV that exceeds 10 is considered to be a possible nuisance odor as it represents an odorant that requires a minimum dilution of 10:1 to reduce the strength of the odorant to below its OTC. Therefore, the OAV action level is equal to 10 and is shown as a dashed red line in the figures. Note that the graph is logarithmic in the “Y” axis scale for OAV.

Note the following:

- Sulfur-based compounds (characterized as rotten eggs, rotting vegetables) are shown as blue.
- Aldehydes (characterized as sweet) are shown as red.
- Carboxylic acids (characterized as rancid) are shown as yellow.
- VOCs (characterization varies) are shown as green.
- Amines (characterized as fishy) are shown as brown.



Figure ES-2. Sampling Event 1 OAV Comparison for ZWED

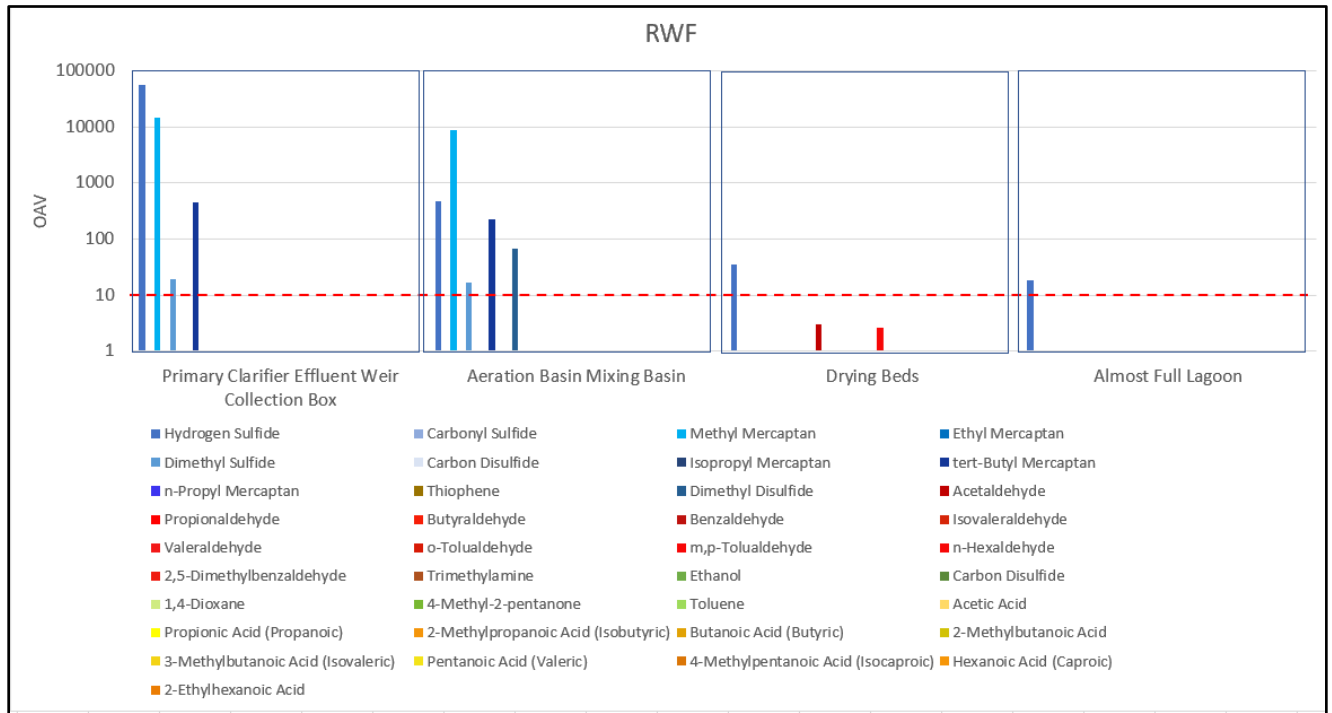

Figure ES-3. Sampling Event 1 OAV Comparison for RWF

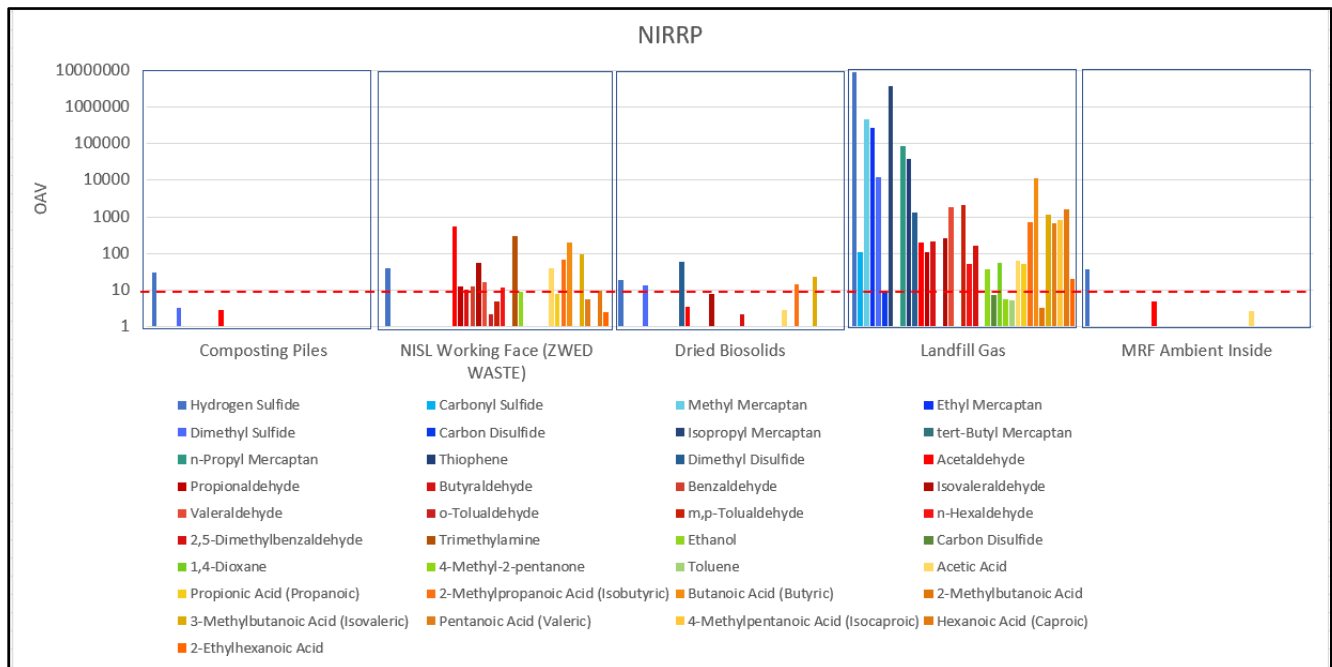

Figure ES-4. Sampling Event 1 OAV Comparison for NIRRP

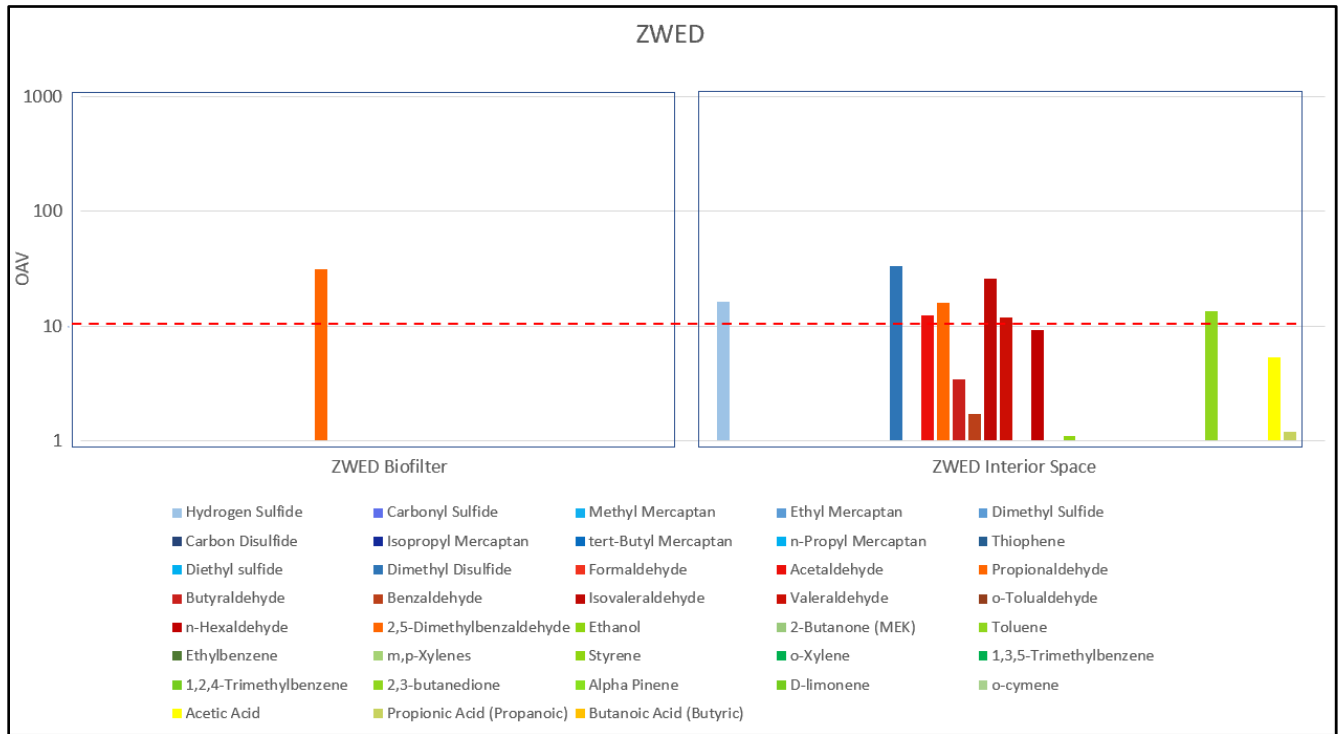

Figure ES-5. Sampling Event 3 OAV Comparison for ZWED

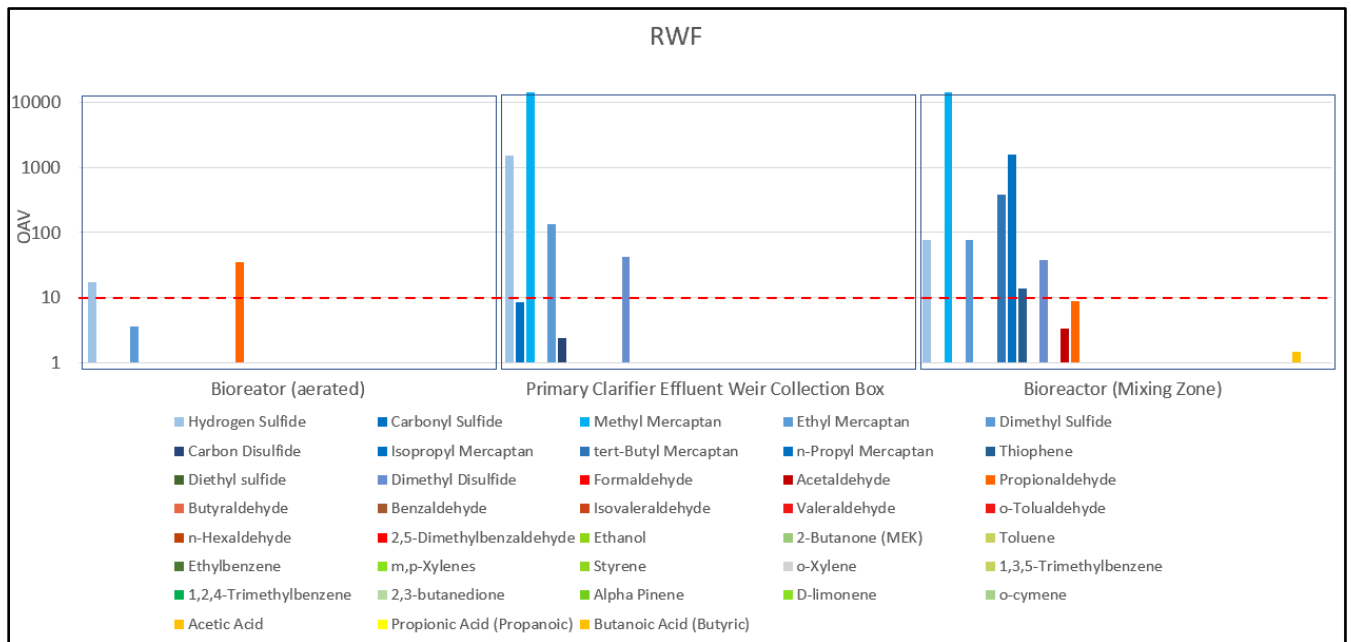

Figure ES-6. Sampling Event 3 OAV Comparison for RWF

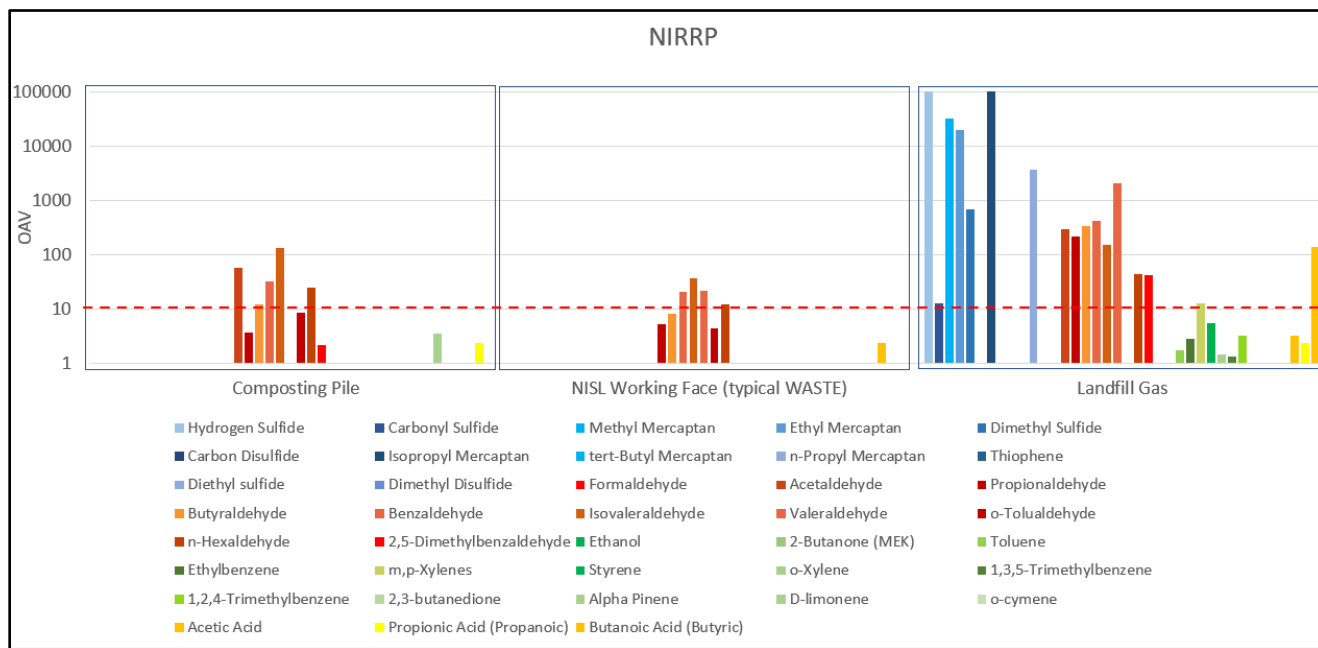

Figure ES-7. Sampling Event 3 OAV Comparison for NIRRP

Key findings from these results include:

- The ZWED interior space source exhibited a combination of rancid, sweet, and sulfur compounds, many of which exceeded the OAV action level. Sample Event 1 odor strength was greater than Sample Event 3 for this source.
- The ZWED biofilter was generally performing well. It exhibited mostly sulfur compounds, several of which exceeded the OAV action level for Sample Event 1. For Sample Event 3, propionaldehyde (sweet, ester) exceeded the OAV action level.
- Odors from the working face of the landfill (traditional waste) were less intense than the odors observed from the ZWED waste during Sample Event 1.
- For the RWF sources, primarily sulfur compounds exceeded the OAV action level.
- Odors from the RWF Bioreactor mixing basins were high (Sample Event 1) while the aerated zone (Sample Event 3) were minor except for propionaldehyde (sweet, ester).
- The NIRRP working face source exhibited a combination of rancid, sweet, and sulfur compounds, many of which exceeded the OAV action level.
- The NIRRP landfill gas source exhibited the highest OAVs of any source, including sulfur, rancid, sweet, and VOC compounds. This was to be expected based on the potency of the source.
- The NIRRP composting area was high in aldehydes. Woody odorants were moderate to low.

Field olfactometry survey efforts were able to determine how each facility impacts downwind regions, with some areas impacted by multiple combined plumes where other areas are believed to be exclusively impacted by a single facility plume, depending on wind conditions. Unique odor descriptors used to describe the odors emitted from the three main facilities were utilized to create a binary large object (BLOB) map. A BLOB map is a visual representation of grouped data that lacks definite shape. Figure ES-8 illustrates the BLOB map that depicts the estimated source of odor emissions pertaining to the odors observed in the community as attributed to the three facilities. The size of the circles is directly related to the measured intensity values, with larger circles generally pertaining to locations closer to odor emitting facilities. The small triangles reflect odor complaint locations.

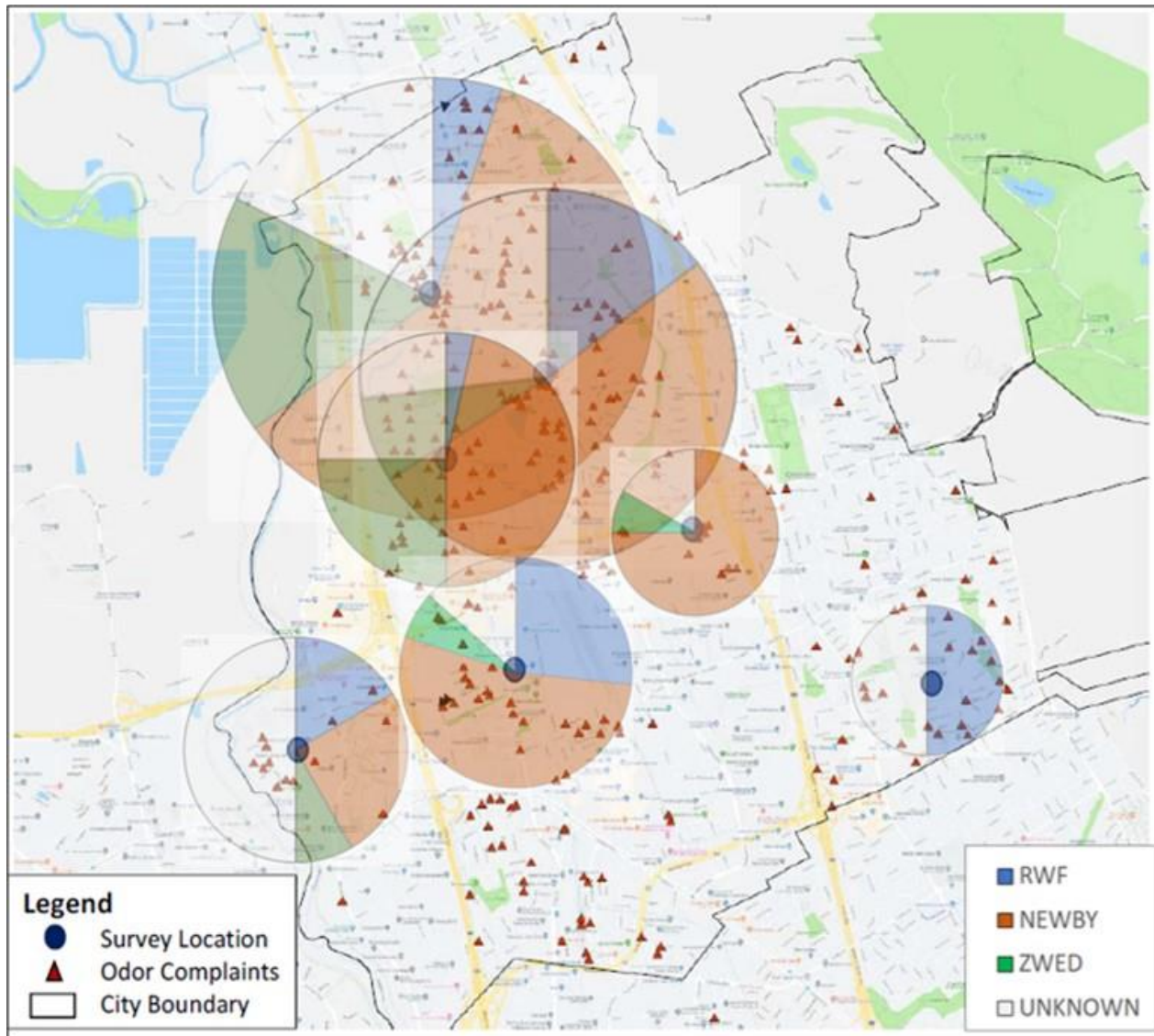

Figure ES-8. Visual Representation of Most Likely Origination of Odors Observed in the Community (Milpitas Community Impact Study)

As depicted in Figure ES-8, all three main odor-emitting facilities contribute to odors frequently observed in the community. Additional findings include:

- Although the odors emitted from ZWED are by far the most intense and the most unpleasant, their reach is mostly limited to only the nearest locations west and southwest in the community in the City of Milpitas.
- Odors emitted from the NIRRP facility contribute to a large extent to the odors observed at most of the discrete survey locations.
- Odors emitted from the RWF contribute mostly at the further away location in the east and southeast of the community (Mt Shasta Avenue).
- The BLOB map can be used as a fairly accurate indication of where impacted odors originate from. This is because the observations have been made over a long period of time (21 months) on multiple individual field assessments (in total 50 assessment on random days of the week and random times of the day) by multiple assessors with similar sensitivity for smell.



A key objective of this Study was to develop a strategy for measuring the frequency and concentration of odor-causing compounds migrating into the local community. The recommended strategy includes provision for a minimum of five odor monitoring stations located strategically at facility fence lines and within the community. These stations would provide more comprehensive understanding of offsite odor impacts, assist in correlating offsite odors to specific facilities, and allow quantification of offsite odor improvements as facilities implement odor mitigation measures. Each odor monitoring station should consist of multi-sensor devices, a weather station, and data process platform for visualization and alarming combined with auto bag samplers for stations located in the community. The approximate cost for each odor monitoring station is \$45,000 plus \$700 for each laboratory analysis.

Auto bag samplers would be initiated upon detection of ambient odor spikes, with bag being collected and sent to a laboratory within the required hold time for analysis. Conducting a proton transfer reaction mass spectrometry (PTR-MS) analysis followed by principal component analysis (PCA) modeling can link offsite community odors to specific facilities/sources. It is possible to attribute plume ratios at a given location in the community to upwind odor sources.

Table ES-1 below summarizes the sources for which abatement is recommended (Jacobs, 2022) and includes the associated odor fingerprints, the associated odor threshold levels (low or moderate), the abatement recommendations, and the responsible party.

**Table ES-1. Source Recommended Abatement Solutions**

Sources	Odor Fingerprints	Thresholds	Recommendations	Facility Responsible Party
<b>ZWED</b>				
Interior Space	Sweet, Rancid, Musty	Low	Seal openings. Alarm at open doors.	ZWED
Rooftop Carbon Filter <sup>a</sup>	Burned Rubber	Low	Test media and change out carbon when spent.	ZWED
Final Product	Sweet, Rancid, Musty	Low	Limit activities including roll-up door actuation when wind is blowing into community.	ZWED
PRVs <sup>b</sup>	Sweet, Burned Rubber	Low	Maintain PRVs to prevent leakage.	ZWED
<b>RWF</b>				
Primaries	Sulfur (Rotten Egg)	Moderate	Provide covers at high emitting areas.	City of San José
Bioreactors	Sulfur (Rotten Egg, Decaying Vegetables)	Low	Provide covers at inlet/mixing zone.	City of San José
Digester PRVs	Sweet, Burned Rubber	Low	Maintain PRVs to prevent leakage.	City of San José
Liquids	Sulfur (Rotten Egg, Decaying Vegetables)	Low	Continue dosing ferrous (consider optimization).	City of San José
<b>NIRRP</b>				
Green Waste	Pine, Rancid, Sulfur	Low	Build process building for odor containment and ventilate to vapor phase odor abatement system.	NIRRP
Landfill Gas	Rancid, Sweet, VOCs	Low	Continue leak detection surveys.	NIRRP

Sources	Odor Fingerprints	Thresholds	Recommendations	Facility Responsible Party
Flares	Mixture (primarily sulfur)	Low	Measure odor content and consider pre-treatment (if necessary).	NIRRP
Multiple Sources <sup>c</sup>	Multiple	Low	Good housekeeping practices.	NIRRP
Biogas/Landfill Gas	Rancid, Sweet, VOCs	Low	Consider biogas utilization system for energy production.	NIRRP
Milpitas Lift Station	Sulfur (Rotten Egg)	Moderate	Ventilation study and new odor control system (currently being implemented).	City of Milpitas
Estuary Culvert	Sulfur (Rotten Egg)	Moderate	Change outlet to reduce turbulence and stripping.	City of San José

Notes:

PRV = pressure relief valve

<sup>a</sup> Carbon filter abating biogas bladder interstitial space

<sup>b</sup> PRVs serve digesters, percolate tanks, and gas holder

<sup>c</sup> Multiple sources include cake stockpiling, leachate tanks, and stormwater pond

## 1. Introduction and Background

Jacobs Engineering Group Inc. (Jacobs) was engaged by the Bay Area Air Quality Management District (BAAQMD) to undertake an Odor Attribution Study (Study) that includes gathering data from specific sources and ambient locations to better understand odor impacts within the local South Bay communities of Milpitas, San José, and Fremont, California.

The primary intent of the Study was to attribute, to the extent possible, odor-causing compounds from three closely located facilities in San José, California, near the City of Milpitas. These facilities include the following:

- Newby Island Resource Recovery Park (NIRRP), which consists of the following operations:
  - Newby Island Sanitary Landfill (NISL)
  - Material Recycling Facility (MRF)
  - Organics Operation Covered Aerated Static Piles (CASP)
- San José-Santa Clara Regional Wastewater Facility (RWF)
- Zero Waste Energy Development (ZWED) dry anaerobic food waste digester facility

In addition, other potential odor sources including San Francisco Bay, a nearby lift station, and an estuary culvert were evaluated.

The main objectives of the odor attribution study included the following:

- Attribution of unique odor-causing compounds from three closely located facilities
- Determination of odorous compound variability over time
- Identification of specific processes and/or sources that emit “fingerprint” odorous compounds
- Development of methods or approaches to monitor and, to the extent possible, quantify identified compounds that cross a given facility’s fence line

The original scope of work included the following key elements:

- Conducting a kick-off meeting to establish a clear and comprehensive understanding of the project background, constraints, objectives, and goals. Roles, responsibilities, and expectations were agreed upon.
- Developing a comprehensive sampling plan focusing on approaches and methodologies approved by BAAQMD and considered legally defensible.
- Attending site tours at the key facilities to meet facility staff and/or management, and to obtain an understanding of relevant operating parameters, emission sources, and emission variability.
- Reviewing existing data including odor complaint information, facility process descriptions, and past odor studies.
- Conducting detailed source and offsite sampling and analyses to determine the odor characterization and most detectable odorants emitted from the key facilities. Multiple sampling events were planned to better understand seasonal variability. Field olfactometric assessments were also conducted to correlate offsite odor intensities and characterizations to odors emitted from the key facilities.
- Performing odor dispersion modeling to understand diurnal and seasonal relative contributions to offsite odor impacts from each key facility.

- Developing a proposed strategy for ongoing odor monitoring. Approach and method to include minimum requirements for the type of sensing monitors, strategic locations, advantages and disadvantages of approaches and methods.
- Completing a final report summarizing findings, results, conclusions, recommendations, and next steps.

The scope was modified after the first sampling event to omit the air dispersion modeling portion of the Study and add more source sampling and analysis. This is mainly because available meteorological data from the nearest weather station, located at San José airport, is not believed to be an accurate representation of the complex wind conditions observed locally around the three key facilities, and therefore inadequate for obtaining useful and accurate results. Significantly more time and effort, including deploying a local weather station, would have required to obtain adequate local meteorological data.

Since the purpose of the initially proposed air dispersion modeling was not to quantify each and every source at each facility but was to be used only to help identify the major odor sources for different offsite areas under typical seasonal weather conditions, it was therefore concluded that a better usage of project funding would be realized by gathering more sampling data. More sampling events provide more data sets to better understand source odor characterization and “fingerprint” odorants and source emissions variability.

In addition, the Study team was able to coordinate with two other studies that were conducted in parallel to this Study to ensure good correlation of results: City of Milpitas’ Odor Study, focused on community odor impacts; and the proton transfer reaction mass spectrometry (PTR-MS) study involving detailed source and offsite sampling conducted by Montrose Environmental Group (Montrose). Coordination with these two parallel studies is discussed later in this Report.

This Final Report provides a comprehensive summary of the endorsed Study scope elements as described above, and is structured as follows:

- Section 1: Introduction and Background
- Section 2: Description of Key Facility Processes
- Section 3: Chemical Compound and Odor Assessments
- Section 4: Evaluation of Odor Monitoring Techniques
- Section 5: Strategy Development for Ongoing Odor Measurement
- Section 6: Findings and Recommendations

## 2. Description of Key Facility Processes

As described in Section 1, three facilities were identified as the primary odor emitters of concern based on reviews of the BAAQMD and South Bay community's odor complaint logs and historical records: the NIRRP, the San José-Santa Clara RWF, and the ZWED facility (Figure 2-1). They are located in close proximity to one another, typically upwind of the impacted South Bay communities during seasonal and/or operational periods that have the highest potential for odor impacts, and their odor emission plumes are often mixed together before reaching the receptors in the downwind communities. This Study was focused on these three facilities, while also considering other natural sources (San Francisco Bay and estuary).

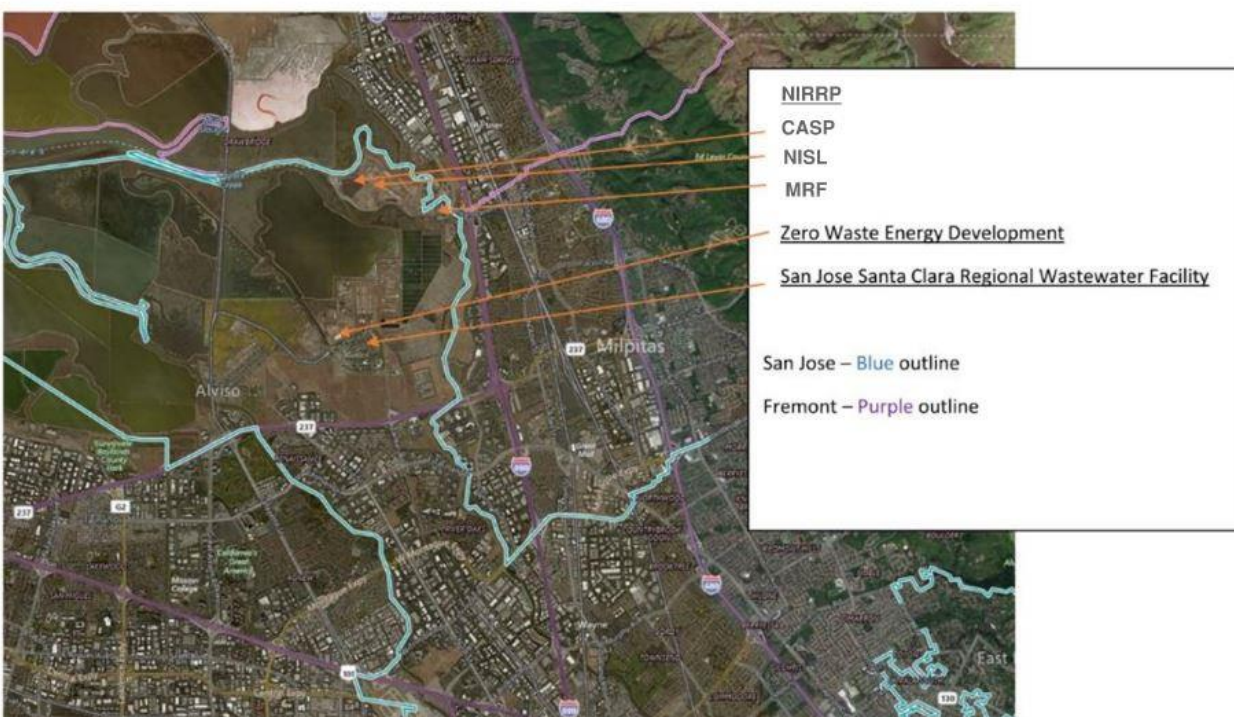

Figure 2-1. Key Odor-Emitting Facilities and Surrounding Communities

The climate in the Study area can be categorized as Warm-summer Mediterranean, with mostly sunny weather and without extreme temperature changes. Winter months are relatively mild ranging from a mean low of 40 degrees Fahrenheit (°F) to 59°F. Rainfall occurs periodically with a winter average of 15 inches. The transition to spring brings warmer weather and infrequent rain. Summer months are dry and warm with temperatures averaging in the mid- to high-80s. While it is typically infrequent, temperatures can exceed 100°F. Fall brings warm temperatures with September typically one of the warmest months due to lack of onshore breezes; it tends to remain dry and sunny into late October.

Wind speeds vary, while during winter winds are typically calm (remaining between 5 and 10 miles per hour). During summer, winds are calm during the morning hours and increase gradually during the day to greater than 10 miles per hour at sites along the Bay. Wind direction is predominantly from the west between February and October and from the north between November and January. Even so, wind direction can shift between morning hours and afternoon hours in the summer months. Furthermore, winds coming off the Bay can create laminar flow conditions that can result in reduced odor plume mixing and dispersion.

The three facilities emit several common odorants (including ammonia, hydrogen sulfide, reduced sulfur compounds, amines, and other biological and chemical based odorants) and “facility unique” odorants. In addition to offsite wastes, the three facilities also receive, process, and discharge waste streams to and from each other, as illustrated on Figure 2-2. For example, stabilized and dried biosolids from the RWF are transported in late summer or early fall and stockpiled at the NISL for use as alternate daily cover for landfill operations. NISL leachate is delivered to the RWF for treatment. The nonbiodegradable waste, or “overs,” from the ZWED operation is transported to NISL.

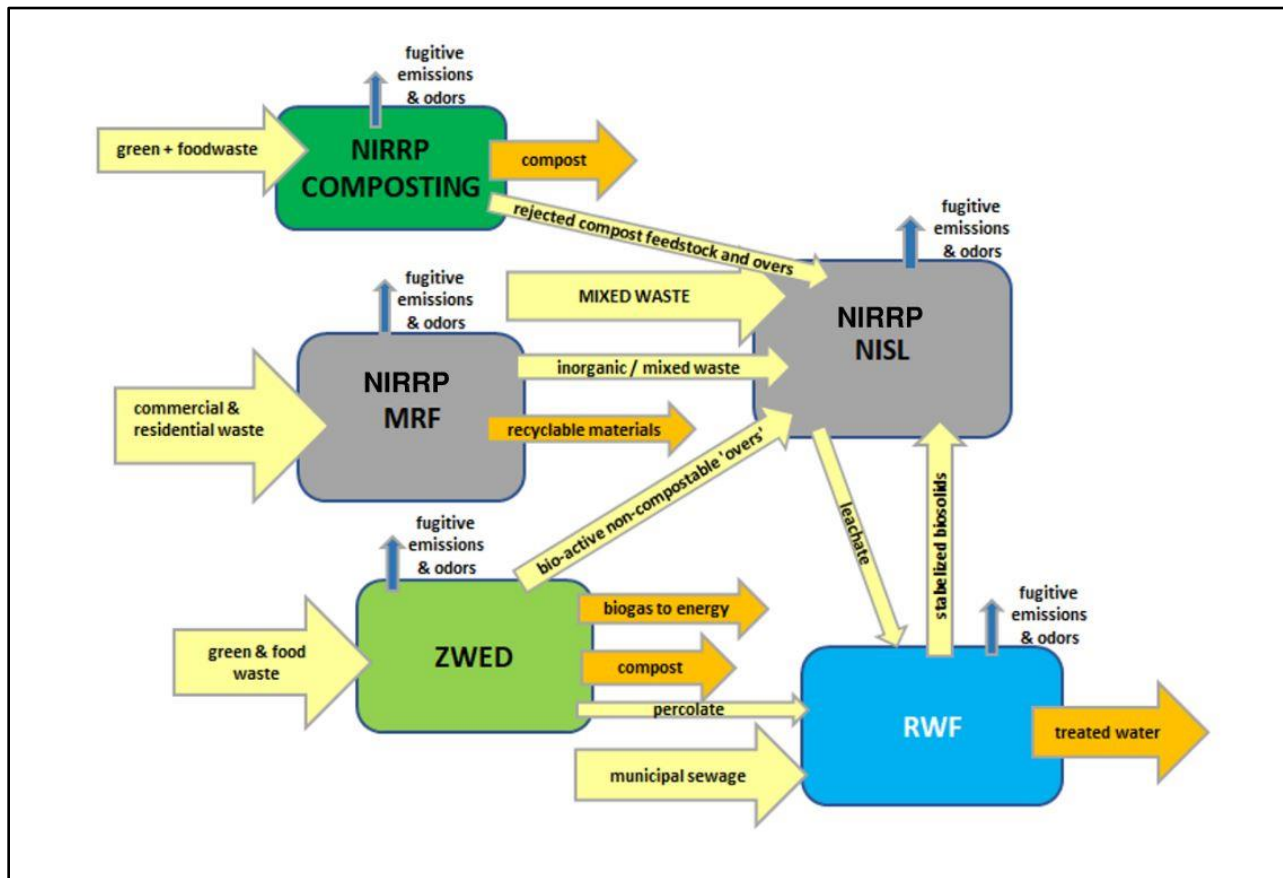

Figure 2-2. Waste Stream Transfers Between Facilities

Bay mud may be considered a significant non-facility odor source, creating background odors that can either mask or worsen odor impacts from odor emitting facilities. Furthermore, tidal variation can impact bay mud emissions. During low tide, decaying organics are exposed and produce the strongest odor. Many complaints historically have come in at around 6:00 PM when residents arrive home, which can lead to increased sensitivity. However, for this study period, the global pandemic shifted work rhythms to more people working from home, making sensitivity time frames more broad. Once the global pandemic subsided, work rhythms returned to normal in the Bay Area. Where tidal conditions occur simultaneously with this timeframe, odor impacts can be exacerbated. For this reason, upwind, downwind, and community locations were characterized as part of this sampling endeavor.

The subsequent subsections provide a general description, process overview, and summary of potential odor sources of each facility.

## 2.1 Newby Island Resource Recovery Park

The NIRRP is operated by Republic Services, Inc. NIRRP consists of five major operations: NISL, BFI Recyclery, MRF, Santa Clara Allied Waste Services (Hauling Company), Construction Demolition Debris, and an organics facility with CASP. NIRRP is on the northern boundary of the City of San José, with Milpitas located on its eastern border and Fremont located immediately north and east of the facility boundary. (Figure 2-1). Fremont residential areas are located further to the north and east. The main residential areas of San José and Santa Clara are to the south and southwest of the facility, respectively.

The facility accepts and processes a wide variety of municipal, recyclable, and industrial waste from the surrounding communities. These wastes can include green waste, limited food waste (such as spoiled milk solids taken to the landfill working face), other food waste comingled with green waste delivered to the composting facility, commercial waste, residential waste, and biosolids material. According to NIRRP staff interviewed during a site visit on June 25, 2020, the amount of overall waste received was 13.9 percent lower than pre-COVID-19 (prior to business closures and travel restrictions resulting from local shelter-in-place orders that went into effect in mid-March 2020). Profiled waste such as sludge and soils returned to pre-COVID-19 levels within months following the implementation of COVID-19 restrictions in March 2020. Municipal solid waste was down 9 percent while other types remained slightly down from pre-COVID-19 levels.

There are four process areas for processing the wastes entering the facility: MRF, working face of the NISL, green waste receiving and grinding area and composting area (CASP), and the biosolids stockpiling area (Figure 2-3). Typically, the wastes enter the facility from the east via trucks and are dumped at various locations throughout the site for further processing, depending upon the types of waste. The landfill gas collection system is also included in Figure 2-3 because this system has high odor emissions potential.

Site operation hours are Monday through Friday from 3 AM to 11 PM and Saturday from 6 AM to 1 PM.

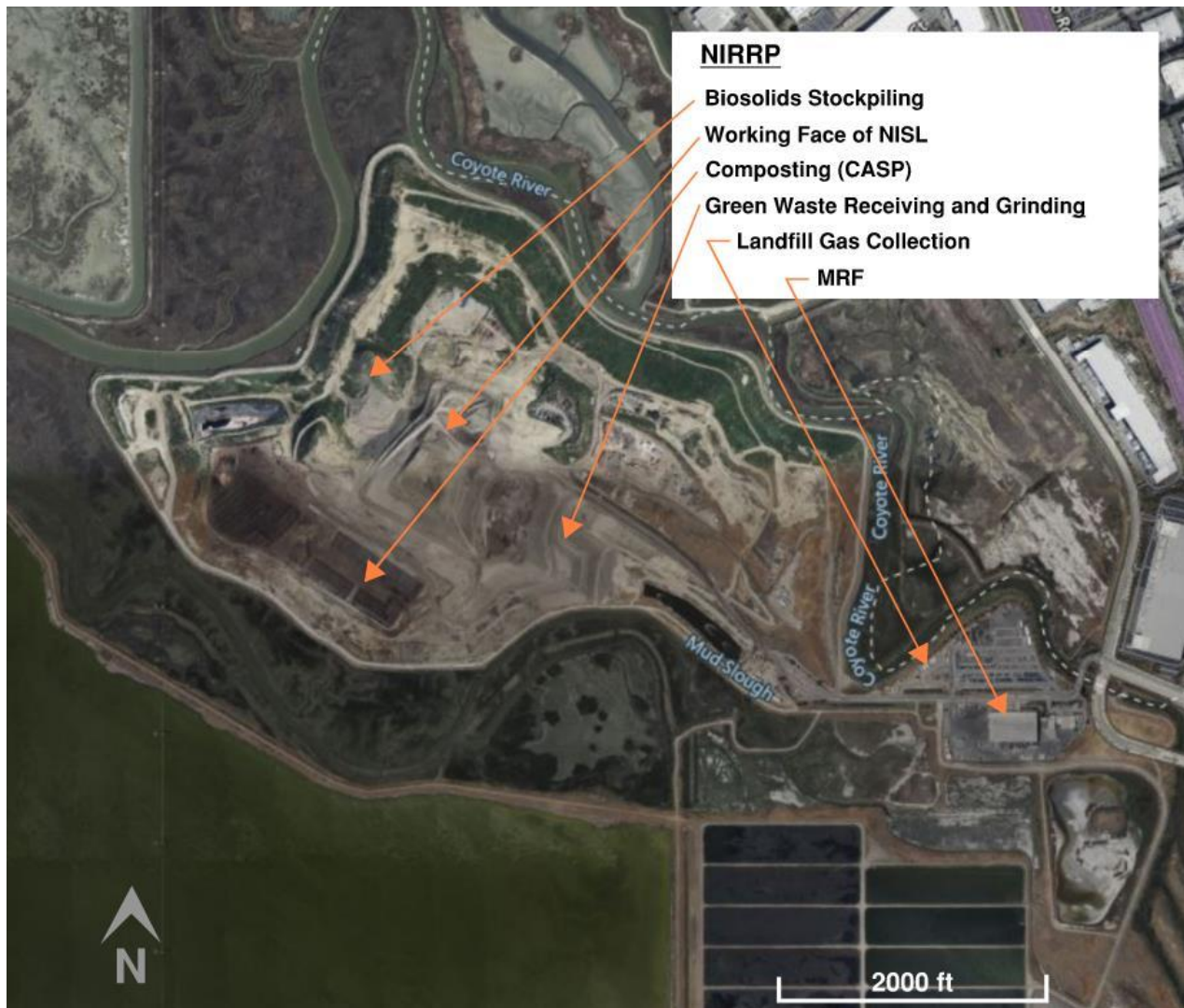

Figure 2-3. Newby Island Resource Recovery Park Facility Map, Milpitas, California  
(Source: Jacobs Image Locator Tool)

The NIRRP has eight odor neutralizing systems placed strategically onsite. Each system consists of the following components: water line, deodorizer, deodorizer pump, and high pressured line with multiple nozzles. The system serving the northeast fence line of the site along Coyote Creek is approximately 1,300 linear feet. The system serving the southeast fence line along the MRF is approximately 1,000 linear feet. When biosolids are delivered in October, the NIRRP rents a large misting system for dust control purposes. Misting systems in all other locations at NIRRP are operated 24 hours per day. It should be noted that neutralizing misting systems are limited in effectiveness to fugitive odors that pass through the misting barrier. Any odors that exhibit a trajectory circumventing the misting barrier will not be mitigated. However, the farther odors circumvent around the barrier, the greater the dispersion. Therefore, one can argue that the most impactful plumes (i.e., those with the shortest direct line to ground level receptors) are mitigated.

The Landfill gas system and leachate collection system are operated 24 hours per day, 7 days per week.

For a detailed description of each key process area within NIRRP – MRF, Landfill Working Face, Green Waste Receiving and Grinding Area, Composting Area, Biosolids Stockpiling Area, Landfill Gas Collection System and Leachate Collection System – please refer to Appendix A.



## 2.2 San José-Santa Clara Regional Wastewater Facility

The RWF is located in the City of San José at 700 Los Esteros Road. It is a publicly owned wastewater treatment plant that includes pretreatment, primary treatment, sludge digestion, secondary treatment, and tertiary treatment. Built in 1956 and expanded several times since, the RWF treats an average of 110 million gallons per day (mgd) of wastewater and has the design capacity to treat 167 mgd. It is jointly owned by the cities of San José and Santa Clara and is managed and operated by the City of San José's Environmental Services Department. The RWF also serves several contributing cities and agencies including Milpitas and Fremont. Figure 2-4 illustrates the overall RWF site plan excluding lagoons and sludge drying beds.

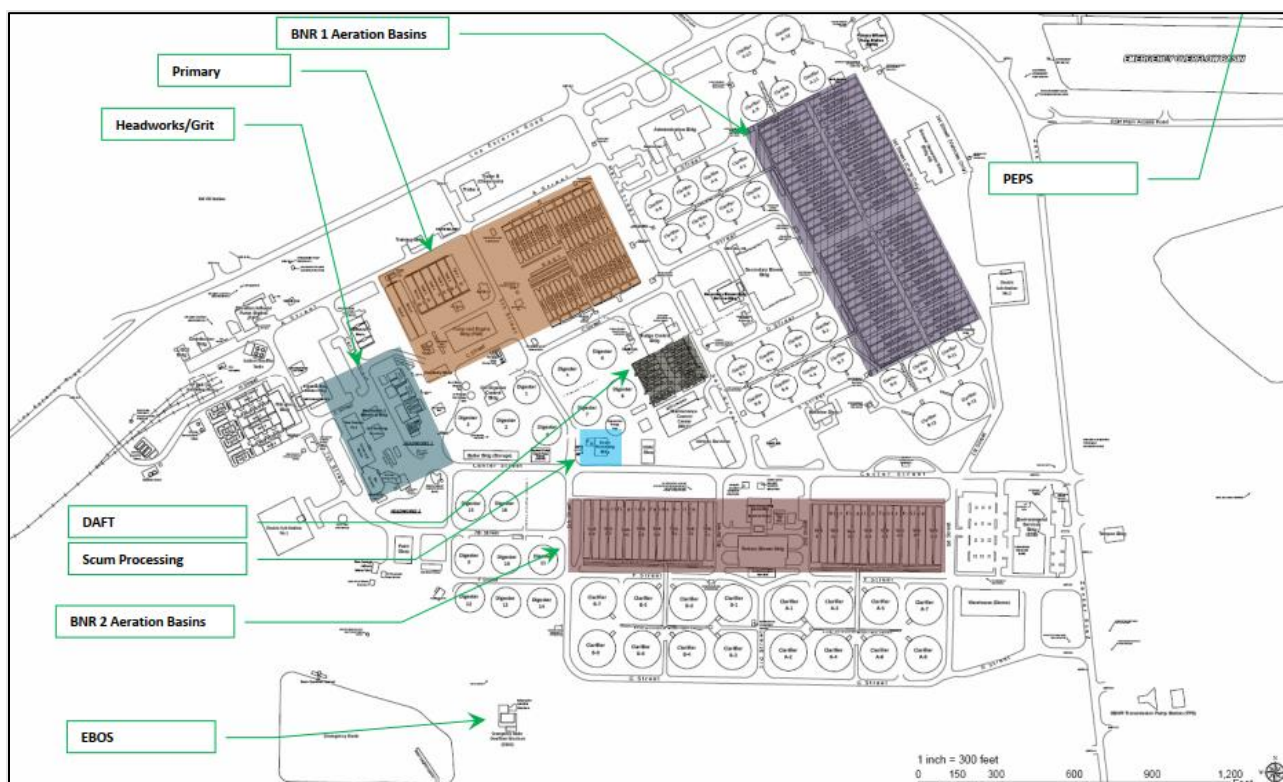

Figure 2-4. San José-Santa Clara RWF Overview  
(Source: CH2M HILL 2012)

The RWF is located on 2,600 acres along the southern shoreline of the San Francisco Bay and includes a 175-acre wastewater processing area, a 750-acre sludge-drying area with lagoons, and an 850-acre former salt production pond that has been restored to a tidal marsh. The remaining acreage is open land that buffers adjacent communities from RWF operations. The RWF has a \$1.4 billion capital improvements program, which began in 2014. Originally planned as a 10-year program, the expected completion date for improvements has been extended. Key upgrades include sludge digestion process, piping, structural improvements, a new flare, construction of a third headworks facility, dissolved air flotation thickener improvements, new cogeneration facilities, and a sludge dewatering facility. Decommissioning of the lagoons is likely to take a minimum of 5 to 6 years.

Jacobs (as CH2M Hill) completed a comprehensive Odor and Corrosion Study in 2015 (CH2M Hill, 2015) in which three separate sampling events were completed along with ambient monitoring. Findings from that work, along with a recent site visit, were used to inform the basis for statements made in this report related to odor potential and proposed sampling locations at this facility.

Based on feedback from RWF staff, there were minimal impacts on total volume of wastewater received at the RWF in 2020 following implementation of COVID-19 Shelter-In-Place orders compared to pre-COVID-19 pandemic levels. While the influent flow did not change significantly after the Shelter-In-Place order was implemented in March 2020, the daily peak flow was found to occur later in the day. These changes did not affect operations.

Wastewater entering the RWF is divided into two key treatment processes: liquid treatment and solid treatment, each having unique odor characteristics. For a detailed description of the liquid treatment and solid treatment processes within the RWF, please refer to Appendix A.

### 2.3 Zero Waste Energy Development Facility

ZWED is a dry fermentation anaerobic digestion (AD) facility located in the City of San José at 685 Los Esteros Road (Figure 2-5) that produces green renewable energy, while simultaneously producing a feedstock for composting. At approximately 41 acres in area, it is the first large-scale commercial dry fermentation AD technology in the United States and is the largest facility of its kind in the world. The facility processes an estimated 90,000 tons per year of “wet” organic waste material that is collected primarily from commercial industries and includes food waste and residential waste (mainly yard trimmings) that would otherwise go to a landfill. The facility is primarily contained within a single building where sorting, digestion, and in-vessel composting occur.

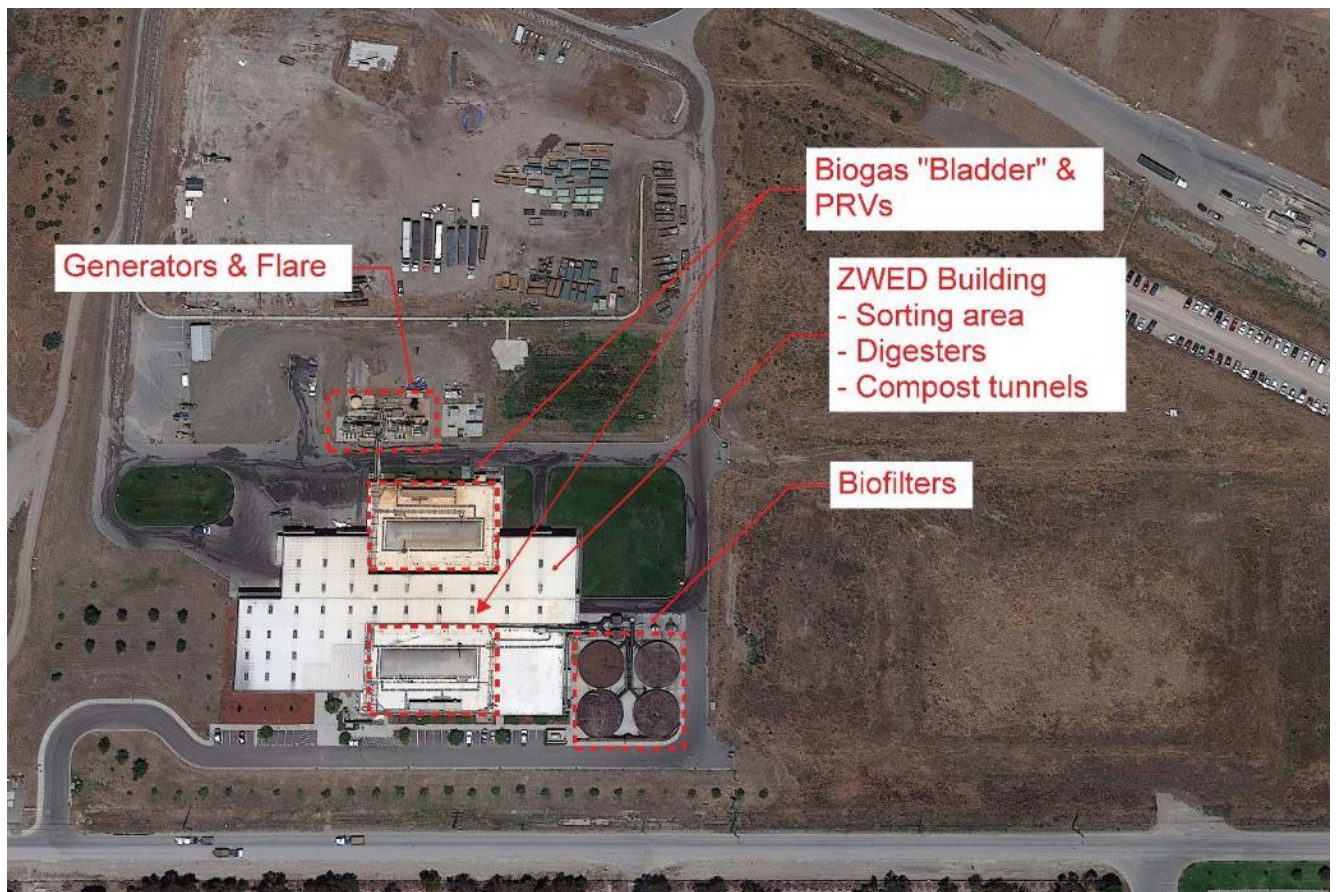

Figure 2-5. ZWED Facility Overview

ZWED sources organic waste (feedstock) from the City of San José and surrounding communities and converts it into biogas through controlled anaerobic conversion of organic materials in large airtight containers (digesters). The biogas is stored onsite and used to power two onsite combined heat and power engines. The main steps in the ZWED process are shown on Figure 2-6. As of May 2020, material is delivered directly to ZWED instead of first being sorted at the Newby Island MRF. This change was implemented to address odor complaints that were traced to the transfer of material from the MRF, as well as the transfer of contaminated materials from ZWED back to Newby Island. At the beginning of the Shelter-In-Place orders implemented in mid-March 2020 in response to the COVID-19 global pandemic, incoming feedstock slowed to almost nothing. By June 2020, incoming feedstock had increased to approximately 50 percent of pre-pandemic levels.

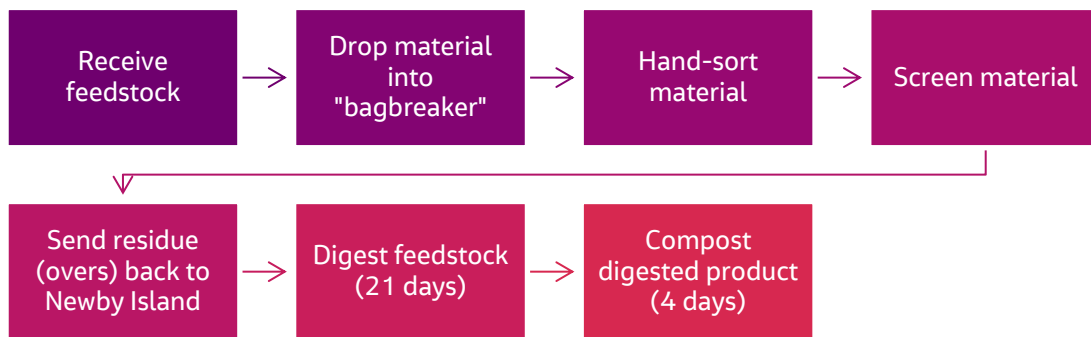

Figure 2-6. ZWED Basic Process Steps

For a detailed description of the process areas within ZWED, please refer to Appendix A.

### 3. Chemical Compound and Odor Assessments

This section presents the field sampling program, sampling event summaries with results for this Study and related studies, and a discussion of the findings.

#### 3.1 Field Sampling Program

The sampling program was designed to support the following Study objectives:

- Identify odorant compounds impacting the area of concern via comprehensive quantitative and qualitative analyses
- Determine the relative contribution and variability of the odor-causing compounds emitted from three identified key odor-emitting source facilities
- Develop a strategy for continuous real-time measurement of these odor-causing compounds from three key odor-emitting sources that may impact the South Bay communities

To achieve these objectives, Jacobs undertook tailored field sampling and laboratory analysis for chemical compound identification of specific odorants, and field olfactometry sampling to provide an understanding of the relative contribution and variability of odor-causing compounds from the three key odor-emitting facilities and how they impact the local South Bay community. The field and laboratory analytical activities for this Study were carried out in accordance with an approved odor emissions sampling and survey plan (Appendix A).

##### 3.1.1 Approach and Methodology

Jacobs conducted four odor sampling events to capture seasonal and/or operational events coinciding with the emitting facilities' variable nuisance odor emissions probability that directly impacts the South Bay communities. Each successive odor sampling event's targeted emissions sources and sampling and analytical suite were built upon the previous odor sampling event's findings and results in order to obtain scientifically reliable results and cross-check results. This Study was generally designed to characterize "worst-case" scenarios.

- The first sampling event, conducted in Fall 2020, was a screening sampling activity with the purpose of identifying the primary nuisance odor characters present at each facility and quantifying odor concentrations and intensities. This event was focused on known, identified odor emission sources from each facility based on a review of historical complaint data and observations from site visits conducted at each facility in June 2020. The full suite of analyses was conducted for this event. The results of the first sampling event were used to fine-tune and adjust the specific sampling locations, numbers of samples, and analytical suites proposed for the next sampling events and to provide screening data for Montrose to plan their future field monitoring activities.
- The second sampling event was conducted in Winter 2020/21 and was a smaller scale event focused on validation of the results from the first sampling event. For this event, only general odor and H<sub>2</sub>S were measured. Bag samples were also collected and sent to Montrose for their study.
- The third sampling event was conducted in Spring 2021 and was a comprehensive sampling event, similar in scale to the first sampling event. The sampling activities were tailored based on the earlier sampling events. During this event, Jacobs coordinated field activities closely with Montrose's field activities to enable correlation of results between the two studies.
- For the Summer 2021 event, only general odor and H<sub>2</sub>S were measured. This event, like the winter event, was a smaller scale validation event.

The sampling and analysis approaches and methods for the four sampling events were designed to conform to industry best practices and approved BAAQMD and EPA methods and protocols. Sampling methodology and analysis methods and approaches are described in general herein. More detailed descriptions are included in Appendix A.

Several potential challenges were anticipated and addressed by Jacobs as follows:

- A full understanding of the operating conditions was essential to effectively plan and implement this study, including determining sampling locations and analytical suites. Jacobs worked closely with BAAQMD to gain access to and active involvement from the key facilities and coordinate with knowledgeable contacts for each facility who understand operation parameters (seasonal/daily/weekly).
- Ambient temperature impacts processes at some of the facilities. In addition, specific seasonal changes (food growing or holiday seasons) can lead to reduced process time generating less stable end-products (compost/ biosolids). Therefore, it was important to tailor sampling events to obtain source sampling results that reflected diurnal and seasonal emission variations.
- A common concern with laboratory analysis for odor is that reporting limit values (i.e., over detection limits) may be greater than human odor threshold values. Specific laboratory analyses were therefore selected to obtain greatest accuracy with respect to laboratory analysis reporting limits when compared to human odor threshold values.
- Where continuous data logging units were utilized, manufacturer-required calibration was implemented for accurate results.
- In March 2020, Shelter-In-Place Orders were implemented throughout the San Francisco Bay Area in response to the COVID-19 pandemic. The extent of potential changes to typical/representative conditions (waste profile, odor emissions, and people affected) due to the effects of the Shelter-In-Place Order were of concern as the sampling plan was being developed in May and June 2020. Jacobs consulted with the source facilities to understand the pandemic-related impacts being experienced and tailored the sampling plan accordingly. By the time of the Spring 2021 sample event, the Study team was confident that COVID-19 impacts to the Study were negligible.
- The historic California wildfires in August and September 2020 resulted in significant air quality impacts within the Study area that were both hazardous to human health and likely to affect ambient measurements collected as part of this Study. As a result, the first sampling event (Fall 2020) which had been planned for September 2020 was delayed to October 2020, both to protect the health and safety of the field sampling teams and to assure the validity of results from samples collected.

### 3.1.2 Field Sample Collection

Jacobs deployed a two-person team for each field sample collection event. The Fall 2020 and Spring 2021 sampling events took place over the course of one week, while the Winter 2020/21 and Summer 2021 sampling events were one to two days in duration. Samples were shipped overnight to laboratories for analysis in accordance with the approved Sampling Plan.

There are two primary modes of sampling: “grab” sampling and “time-integrated” sampling. To achieve the goals of this sampling effort, grab samples were conducted for all bag samples, while H<sub>2</sub>S data loggers were deployed for obtaining time-integrated sampling results at limited sources. Generally, time-integrated sampling is more useful where a time-based average is sought.

The following sample collection methodologies were used to accommodate the range of odorous emission sources present at the focus facilities:

- **Area Sources:** There are two commonly used methods for collecting air samples from area sources. These include the flux chamber technique and the wind tunnel technique. Due to difficulties in setting up the wind tunnel technique method, and the fact that the flux chamber method is considered industry standard, the flux chamber technique was implemented to collect air/odor samples from area emission sources (e.g., lagoons, compost piles, and aerated liquid/solid processes). This approach is accepted by EPA and BAAQMD for air quality emissions sampling and was applied to address target odorants in the same fashion. Section 3.1.3 contains details pertaining to both liquid and solid surfaces.
- **Fugitive Interior Space Sources:** Sampling from sources such as interior spaces with open doors or windows used a lung (vacuum chamber) technique to collect bag samples (Section 3.1.3.1) placed in a location within the space to (1) limit dilution effects from open doors and windows, (2) ensure odor is well mixed, and (3) limit dilution from makeup air systems.
- **Point Sources:** Point or stack odor emissions sources were sampled using bag sampling (refer to Section 3.1.3.1). Point sources including ducts and stacks were sampled using a lung (vacuum chamber) connected to the source via an air-tight connection and inert (such as Teflon) tubing. Multi-point sampling was not believed to be necessary since uniformity and homogeneous mixing within the duct is assumed (EPA, 2012).
- **Atypical Sources:** Atypical sources were sampled as follows:
  - Pressure Relief Valves (PRVs): For this type of source, the technique described for point sources was employed with the extraction tube inserted into the PRV hood assembly to limit environmental impacts due to wind.
  - Aerated Surface Area Sources: Same as area sources except that process air flux rate was incorporated into calculating any surface emission factors.
  - Undulating Surface Area Sources: Sources including RWF Primary Clarifier Effluent Launder consist of features that prevent the sealing of flux chamber bottom to source surface. For these types of sources, the flux chamber was sealed by placing it on a float, and the float was placed on the turbulent feature as practical while meeting the requirements set out in the Sampling and Odor Survey Plan (Appendix A).

The sources where bag samples were taken were also sampled with the field olfactometer at around the same time. The timing of collecting field olfactory measurements had to be coordinated with the survey work in the community. For this reason, grab sample and field olfactometry measurements did not occur at the same time, but did occur under similar meteorological and process operations conditions. The measurement with the field olfactometer was used as quality control and laboratory result confirmation. Sources were sampled with the field olfactometer at a different time during the sampling day or at a different day to improve the accuracy of the odor concentration measurement depending on the results and the contribution of the source to the total odor emission at the plant.

### 3.1.3 Flux Chamber Sampling (for area sources – liquid and solid surfaces)

The surface emission isolation flux chamber can be used on any liquid surface and on solid surfaces (an EPA flux chamber is shown on Figure 3-1). The flux chamber methodology employed complied with EPA Environmental Restoration Division Standard Operating Procedure 1.11, Soil Surface Flux Monitoring of Gaseous Emission (1999f).

Two different EPA chambers exist. One is a South Coast Air Quality Management District (SCAQMD) modified EPA flux chamber for higher flow rates (e.g., biofilters and composting including stockpiles where flows exceed 6 to 7 liters per minute for conventional 16-inch diameter flux hood) and was not used on this project due to unit unavailability and lack of technical justification. The SCAQMD modified flux chamber allows for an accurate assessment of flux from advective sources without the suppression of species flux. The other is for low-flow diffusive sampling conditions. The specific operating protocol for the EPA-approved low-flow flux chamber is described in detail in Appendix A.



Figure 3-1. EPA Flux Chamber with Sampling Equipment

There are two types of flux-chamber methods: Static (Closed) Chamber Method and Dynamic Chamber Method. The dynamic-chamber method is considered industry standard and was used on this project. This method includes introduction of sweep gas during a pre-set incubation period to ensure steady-state conditions are met.

For sampling natural or uncontrolled systems, the most critical issue regarding application is that the location and number of locations for testing be sufficient so that these data can be used to calculate the total emissions from the emitting surface area. The *Measurement of Gaseous Emission Rates from Land Surfaces Using an Emission Isolation Flux Chamber User's Guide* (EPA, 1986) provides guidance that relies on the area involved and the homogeneity of the source or the coefficient of variation of these emission data for determining representative testing.

For sampling engineered systems (process tankage), the representative surface areas are selected. Given that the solid/liquid surface tested is relatively uniform, it is anticipated that the measurements will be representative of the air emissions from the process.

#### 3.1.3.1 Bag Sampling (for flux chamber emissions and point sources)

Samples using Tedlar and Teflon bags were collected directly from the vacuum chamber connected to the exhaust line of the flux chamber (area source) at steady-state conditions or connected to the stack or duct sources (point sources) as described. Bags were then sent to the defined laboratory for speciation by gas chromatography (GC), odor analysis, Odor Profile Method (OPM), or musty and fecal analysis. Sampling rate was maintained at less than 2.0 liters per minute (L/min) from the vacuum chamber. Sample bags were filled by connecting the sampler to the sampling port on the flux chamber using the ¼-inch Swage-lock fittings, drawing a vacuum on the vacuum chamber, filling the bag, and collecting a 1- to- 20-liter sample. Sample bags were preconditioned by partially filling, then expelling, the bag contents with the sample prior to taking the final sample.

Bags were Tedlar material for all analysis types except for bags sent to University of California-Los Angeles (UCLA) (for OPM analysis) and Montrose (for identifying a wide range of individual compounds and specific

markers using proton transfer reaction [PTR] technology). Due to the potential “sticky” nature of fecal odorants, samples sent to UCLA and Montrose were in Teflon bags (Suffet, 2016).

BAAQMD does not generally allow use of Tedlar bags for total reduced sulfur (TRS) analysis. Sulfur poses challenges with regard to sample bag material, as it decays in Tedlar bags and exhibits wall diffusion through the polymeric film in Teflon bags. If samples are analyzed within appropriate holding time (24 hours in this case), these materials are considered acceptable. Due to this reason, samples were shipped overnight for all sampling events and analyzed within 24 hours of sampling.

### 3.1.3.2 Sorbent Media Sampling

Sorbent media samples were collected using variable flow sampling pump connected directly to the source (point source) using Teflon tubing or to the exhaust line of the flux chamber (area source). Sampling rate was maintained at the recommended rate determined by the laboratory conducting the analysis. The sampling pump was calibrated before use and operated for the recommended sampling time to pull the required volume through the media in each tube. This time varied depending on the type of sorbent media and went up to 1 hour and 45 minutes. The sampling pump was post-calibrated after use and the average of the pre- and post-calibration used to calculate the average flow rate of the sample collection for the timed interval. Figure 3-2 shows a typical setup for sampling off a stack using multiple sampling pumps and sorbent tubes.



Figure 3-2. Sorbent Tubes and Sampling Pumps

In order to sample every source in the allotted timeframe, it was necessary to reduce some of the sorption tube runs to 60 minutes instead of 100 minutes as planned during Sample Event 1. The run times were not reduced for the remaining sample events in this Study. The reduced run times of Sample Event 1 had negligible impacts to overall sorption tube results for this Study. The Study was designed to build on successive sample event, with Sample Event 1 as a screening event and Sample Event 3 as the comprehensive sampling event that included coordination with the Montrose sampling activities.

### 3.1.3.3 Explosive Source Sampling

Some sources, such as the landfill biogas source, exhibited high concentrations of methane exceeding the lower explosive limit. A bag sample of such sources is considered explosive and cannot be shipped to the laboratory using conventional methods, thus the following approach was implemented:

- Using a hand-held methane sensor, sample gas methane concentration was measured and recorded.
- Using a high-purity nitrogen tank, rotameter, and tubing assembly, the Tedlar or Teflon bag was pre-charged with a preset volume of inert nitrogen gas (approximately 60 percent full).
- Preliminary calculations estimated that a minimum dilution ratio of 100:1 will be required for landfill biogas. Typical landfill biogas can exhibit odor concentrations in the range of 2,000,000 and 3,000,000 D/T. Therefore, diluting 100X will reduce expected sample concentration to 20,000 to 30,000, which falls below the maximum detectable St. Croix laboratory limit. For the purpose of this study, this approach was adopted during the sampling events.
- Using a flux hood and/or vacuum chamber complete with rotameter, the sample bag was filled with a preset volume of sample gas (1/100 x volume of pre-charge volume).



- Using hand-held methane sensor, methane concentration was measured and recorded from bag.

### 3.1.4 Laboratory Analytical Methods

All foul air samples were analyzed by ALS Environmental Laboratories (ALS) (Simi Valley, California); odor threshold by St. Croix Sensory (Stillwater, Minnesota); and by the OPM and GC/mass spectrometry (MS) in parallel with GC-Sniff testing by UCLA (Los Angeles, California).

#### 3.1.4.1 Summary of Analytical Methodologies

Table 3-1 summarizes the targeted sampled odorant and the conforming BAAQMD approved analysis and protocols used during the four sampling events.

**Table 3-1. Summary of Targeted Sampled Odorant and Protocols**

Odorant	BAAQMD Analytical Method	EPA Analytical Method	Industry Accepted Analytical Method	UCLA Analytical Method	Odor Laboratory Analytical Method
Reduced Sulfur Compounds	ST-11 (BAAQMD 1982c) ST-08 (BAAQMD 1982b)	EPA Method 16M	ASTM D5504 Method by Modified GC/SCD with sulfur chemiluminescence detection.	N/A	N/A
General Odor	ST-12 (BAAQMD 1982d)	N/A	ASTM E679-04 Standard of Practice with a presentation rate of 20 L/min (per EN 13725)	N/A	ASTM E679-04 Standard of Practice with a presentation rate of 20 L/min (per EN 13725)
OPM	N/A	N/A	N/A	Modified Standard Method 2170: Flavor Profile Method	Limited Intensity/ Dilution Curves
Methyl Isoborneol (MIB) Isopropyl Methyl Pyrazine (IPMP) Skatole Indole	N/A	N/A	N/A	GC/MS	N/A
Aldehydes	N/A	TO-05 (EPA 1999a) TO-11A (EPA 1999b)	TO -11A (EPA 1999b)	N/A	N/A

Odorant	BAAQMD Analytical Method	EPA Analytical Method	Industry Accepted Analytical Method	UCLA Analytical Method	Odor Laboratory Analytical Method
Amines	ST-22 (BAAQMD 1982f)	EPA CTM-027 (EPA 1997)	ALS (sorbent tube) Method 101 (their unique standard method) SCAQMD Method 207.1 (SCAQMD 2006) (amines as well as ammonia) Atmospheric Analysis and Consulting, Inc.; impinger gets to lower MRL	N/A	N/A
Ammonia	BAAQMD ST-1B South Coast AQMD Method 207.1 (SCAQMD 2006)	N/A	OSHA ID-188 method Draeger tubes South Coast AQMD Method 207.1 (SCAQMD 2006) (amines as well as ammonia)	N/A	N/A
H <sub>2</sub> S	ST-21 (BAAQMD 1982e)	EPA Method 16M	Jerome (< 50 ppmv) Draeger tubes (> 50 ppmv) OdaLog/Acrulog (> 0.1 ppmv) ASTM D5504 Method by Modified GC/SCD with sulfur chemiluminescence detection (5 ppb MRL).	N/A	N/A
VOC <sup>a</sup>	TO-15 (EPA 1999d)	TO-14 (EPA 1999c) TO-17 (EPA 1999e) TO-15 (EPA 1999d)	TO -17 (EPA 1999e) TO -15 (EPA 1999d)	N/A	N/A
Carboxylic Acid	N/A	N/A	ALS (sorbent tube) Method 102 (their unique standard method)	N/A	N/A

<sup>a</sup> EPA Method TO-15 uses Summa canister and generally has larger list of compounds. EPA Method TO-17 uses pump with sorbent tube and can characterize a broader range of target odorants, including semi-volatile (water soluble) compounds. TO-17 preferred over TO-15.

Notes:

- ALS = ALS Environmental Laboratories
- CTM = Conditional Test Method
- HPLC = High Performance Liquid Chromatography
- MRL = Method Reporting Limit
- OSHA = Occupational Safety and Health Act
- ppmv = part(s) per million by volume
- ppb = part(s) per billion
- SCD = sulfur chemiluminescence detector
- ST = Source Test
- TO = Toxic Organics

Table 3-2 summarizes the analytical methods. In some cases, specific odorants are listed that fall under a broader category. For example, specific reduced sulfur compounds fall under the broader category of Total Reduced Sulfur Compounds. Laboratory testing was performed in accordance with the associated test methods

and approved test protocol. Percent concentration recovery in all cases fell within the associated quality control limits. For specific measurement uncertainties, refer to the laboratory reports in Appendix B.

**Table 3-2. Analytical Methods and Reporting Limits**

Odorant	Low Odor Threshold (ppbv) <sup>a</sup>	Sampling Technique	Analytical Technique	Method Reporting Limit (ppbv)
Methyl Mercaptan	0.077	Grab sample into 1-L Tedlar or other <sup>b</sup> bag	ASTM D5504 Method by Modified GC/SCD with sulfur chemiluminescence detection.	5.0
Dimethyl Disulfide	0.22			2.5
Dimethyl Sulfide	3.0			5.0
H <sub>2</sub> S	0.51			5.0
Ammonia	1,300	Sorbent tube or Draeger tube	OSHA ID-188 method	600
Amines	Varies 0.032	Sorbent tube	ALS Method 101	Varies 0.8
VOCs and similar	Varies	Sorbent tube	TO-17	Varies
OPM	N/A	Grab sample into 10-L Teflon bag	SM 2170 applied to air samples	N/A
Methyl Isoborneol (MIB)	0.02	2-Grab sample into 10-L Teflon bag within 6 hours	GC/MS	0.04
Isopropyl Methyl Pyrazine (IPMP)	0.004			0.1
Skatole	0.018			0.15
Indole	0.5			0.25
General Odor (dilutions-to-threshold)	N/A	Grab sample into 10-L Tedlar bag	Odor panel per ASTM E679-04 Standard of Practice with a presentation rate of 20 liters per minute (per EN 13725)	N/A

<sup>a</sup> OTVs as determined during Phase I of OCSD Odor Control Masterplan project and recognized published papers

<sup>b</sup> It is noted that BAAQMD does not allow the use of Tedlar bags for TRS analysis, unless samples are analyzed within appropriate holding time (24 hours in this case). In that case, this material are considered acceptable. Due to this reason, samples were shipped overnight for all sampling events and analyzed within 24 hours of sampling.

Note:

OSHA = Occupational Safety and Health Act

ppbv = part(s) per billion by volume

### 3.1.4.2 Odor Profile Method

OPM has been used since the 1980s to characterize odor sources and to identify effective analytical methods in order to understand what causes odor problems in drinking water. OPM uses odorant standards of odors typically present in waste treatment processes to train panelists before using real-life odor samples. The odors assessed are rated by their particular odor strength using a seven-point odor intensity scale. The use of the Weber-Fechner Law translates the intensities detected by the panelists into odorant concentration. The usefulness of the OPM lies in the fact that the human nose is, for the most important odorants, many degrees more sensitive than the standard analytical methodologies. The proof of this is that even though a chemical sample result may show non-detects for all compounds, the D/T of that same sample comes back with considerable odor dilution to

threshold results. The Weber-Fechner curves were then used to determine each "most detectable" odorant's nuisance concentration equivalent to an Odor Intensity value of 3 (Figure 3-3).

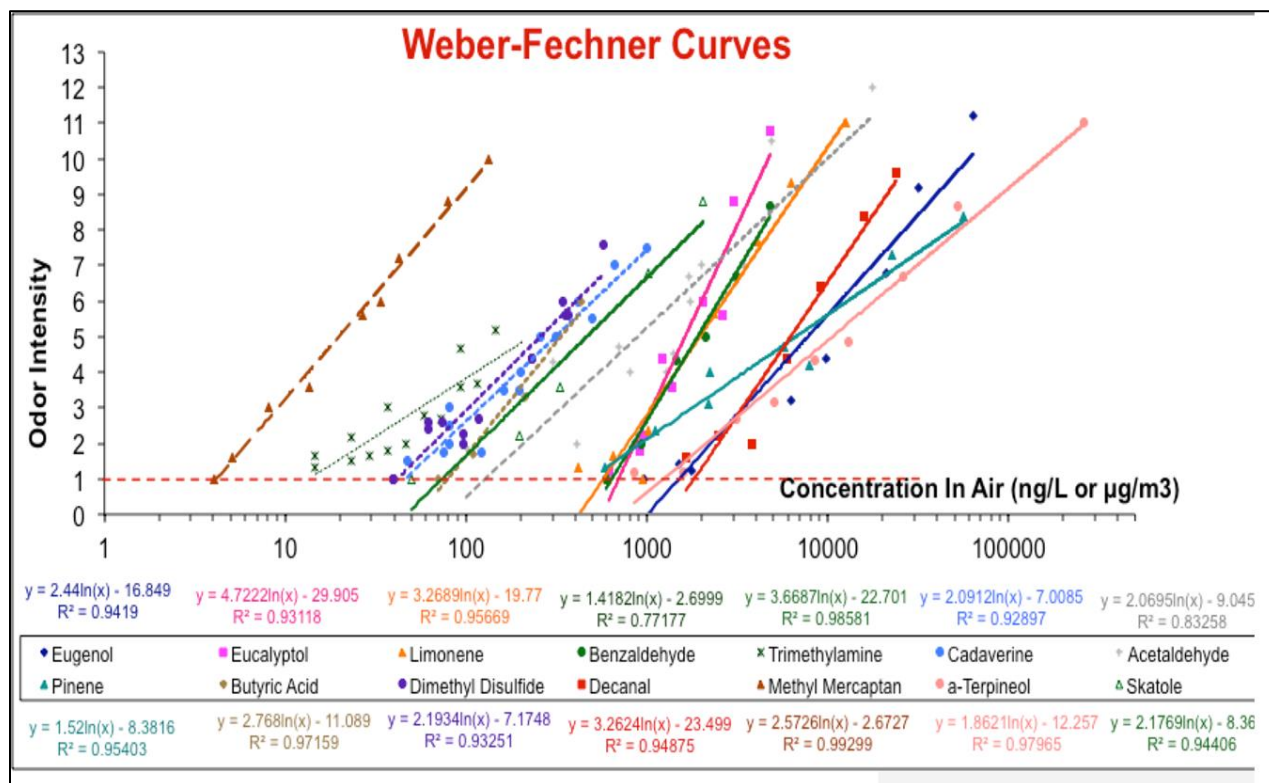

Figure 3-3. Weber-Fechner Curves for Various Odorous Constituents

The OPM was completed at UCLA by a panel of a minimum of four trained panelists. OPM is a modification of Standard Method 2170: The Flavor Profile Analysis (FPA) Method (APHA, 2012). The panelists identified multiple odor characters in a single sample based upon the Wastewater Odor Wheel and their respective intensities based upon the 7-point Weber-Fechner scales. The Weber-Fechner scale including 0 (no odor), 1 (threshold), 2, 4, 6, 8, 10, and 12 was used for intensity. The OPM panelists associated the intensity of each odor using a surrogate sugar-solution scale used for the FPA Method. Levels on the scale are taste-based rather than odor-based yet still afford calibration of either sense. A certain concentration of a taste-based sugar standard is defined as a certain point on the scale and a numerical rating for intensity is assigned.

The OPM results are presented in a graphic (persistence curve) that show the log dilution to intensity with the odor character reported for each dilution as developed by the group of Dr. Mel Suffet of the University of California-Los Angeles (Burlingame, 1999, 2009). The usefulness of the OPM lies in the following: (1) the human nose is, for the most important odorants, many degrees more sensitive than the standard chemical compound identification analytical methodologies; and (2) the persistency of odorous compounds can differ from each other and therefore quantifying the odor intensity reduction with dilution and characterizing the dominant type of odors can help with understanding what type of odorous compounds are most critical when impacting the community for developing odor control strategies. Refer to the figures in subsections 3.2.1.4.2, 3.2.3.4.2, and 3.2.4.4.2 for examples of persistency curves.

### 3.1.4.3 Laboratory Analyses for Constituent Groupings

ALS performed the following analysis by using either Tedlar bag sampling or Sorbent media sampling methods (Table 3-3 and Table 3-4 contain the list of constituents in each grouping):

- 1) **Reduced Sulfur:** Samples were tested for 20 reduced sulfur compounds (including H<sub>2</sub>S) using a gas chromatograph/flame photometric detector following ASTM D5504. The goal of this analysis is to detect the presence, if any, along with the relative concentration of the 20-reduced sulfur species.
- 2) **Carboxylic Acid:** Carboxylic acids (volatile fatty acids [VFAs]) were analyzed using ALS Method 102, which is a validated in-house method. Samples were collected by using a 1 L/min sampling pump to pass 100 liters (L) through a treated silica gel tube at a flow rate of 1 L/min until 100 L of volume had passed through the tube. The sample tubes were then sent to ALS and analyzed using a process that involves the derivatization of carboxylic acids, with subsequent analysis by GC/MS. Using the recommended sample volume of 100 L makes it possible to achieve levels as low as of 2.5 to 5.0 micrograms per cubic meter (µg/m<sup>3</sup>).
- 3) **Amines:** Amines were analyzed using ALS Method 101. Samples were collected by using a 1 L/min sampling pump to pass 100 L through a specially treated sorbent tube that is used to detect the 13 target amine compounds. The sample tubes were then sent to ALS where they were desorbed and analyzed by GC using a nitrogen phosphorus detector. This method allows the detection of target amines present at levels as low as 2 µg/m<sup>3</sup> as long as a minimum of 100 L of volume is passed through the tube.
- 4) **Aldehyde:** Aldehydes were analyzed in accordance with EPA Method TO-11A. Samples were collected by using a 1 L/min sampling pump to pass 100 L through an acidified 2,4-dinitrophenylhydrazine -coated sorbent tube. Tubes were then sent to ALS for analysis via reverse phase high-performance liquid chromatography with ultraviolet detection.
- 5) **Ammonia:** Ammonia was collected by using a 1 L/min sampling pump to pass 100 L through a sulfuric acid-coated Anasorb-747 (carbon bead) tube. Tubes were then sent to ALS where they were analyzed using the Occupational Safety and Health Act (OSHA) Method ID-188, which uses an ion-specific electrode to detect ammonia.
- 6) **VOCs:** VOCs were analyzed following EPA Method TO-17. Samples were collected by using a 100 milliliters (mL) per minute sampling pump to pass 4 L of odorous air through a carbotap 300 tube. Tubes were then sent to the laboratory to be thermally desorbed and analyzed by GC/MS. Method TO-17 identifies up to 61 standard compounds shown in Table 3-4. In addition to the standard list, the tubes were also analyzed for up to 20 compounds in the National Institute of Standards and Technology library that includes over 120,000 compounds. These compounds were detected using spectral comparison and are considered tentatively identified compounds. Included in this library of compounds are common wastewater odors Skatole and Indole (both fecal odorants).

**Table 3-3. List of Sub-compounds for Selected Tests**

Amines	Aldehydes	Carboxylic Acids	Sulfur Compounds
Butylamine	Formaldehyde	Acetic Acid	n-Butyl mercaptan
s-Butylamine	Acetaldehyde	Butanoic acid (Butyric acid)	tert-Butyl mercaptan
t-Butylamine	Propionaldehyde	Heptanoic acid	Carbon disulfide
Diethylamine	Crotonaldehyde, Total	Hexanoic acid	Carbonyl sulfide
Diisopropylamine	Butyraldehyde	2-Methyl butanoic acid	Diethyl Disulfide
Dimethylamine	Benzaldehyde	Methyl butanoic acid (Isovaleric acid)	Diethyl Sulfide
Dipropylamine	Isovaleraldehyde	Methyl propanoic acid (Isobutyric acid)	Dimethyl disulfide

Amines	Aldehydes	Carboxylic Acids	Sulfur Compounds
Ethylamine	Valeraldehyde	2-Methylpentanoic acid	Dimethyl sulfide
Isobutylamine	o-Tolualdehyde	3-Methylpentanoic acid	2,5-Dimethylthiophene
Isopropylamine	m,p-Tolualdehyde	4-Methylpentanoic acid	Ethyl mercaptan
Propylamine	n-Hexaldehyde	Octanoic acid	Ethyl methyl sulfide
Triethylamine	2,5-Dimethylbenzaldehyde	Pentanoic acid (Valeric acid)	2-Ethylthiophene
Trimethylamine		Propanoic acid	Hydrogen sulfide
		2-Ethyl hexanoic acid	Isobutyl mercaptan
		Nonanoic acid	Isopropyl mercaptan
			Methyl mercaptan
			3-Methylthiophene
			n-Propyl mercaptan
			Tetrahydrothiophene
			Thiophene

**Table 3-4. List of 61 Standard VOCs Using EPA Method TO-17**

Method TO-17- VOCs Standard Compound List		
Dichlorodifluoromethane (CFC 12)	Chloroform	2-Hexanone
Chloromethane	Tetrahydrofuran (THF)	Dibromochloromethane
1,2-Dichloro-1,1,2,2-tetrafluoroethane (CFC 114)	1,2-Dichloroethane	1,2-Dibromoethane
Vinyl Chloride	1,1,1-Trichloroethane	n-Octane
1,3-Butadiene	Benzene	Tetrachloroethene
Chloroethane	Carbon Tetrachloride	Chlorobenzene
Ethanol	Cyclohexane	Ethylbenzene
Acetonitrile	1,2-Dichloropropane	m,p-Xylenes
Acetone	Bromodichloromethane	Bromoform
Trichlorofluoromethane	Trichloroethene	Styrene
2-Propanol (Isopropyl Alcohol)	1,4-Dioxane	o-Xylene
1,1-Dichloroethene	2,2,4-Trimethylpentane (Isooctane)	1,1,2,2-Tetrachloroethane
Methylene Chloride	n-Heptane	Cumene
Trichlorotrifluoroethane	cis-1,3-Dichloropropene	1,3,5-Trimethylbenzene
Carbon Disulfide	4-Methyl-2-pentanone	1,2,4-Trimethylbenzene
trans-1,2-Dichloroethene	trans-1,3-Dichloropropene	1,3-Dichlorobenzene
1,1-Dichloroethane	1,1,2-Trichloroethane	1,4-Dichlorobenzene
Methyl tert-Butyl Ether	Toluene	1,2-Dichlorobenzene
2-Butanone (MEK)	Hexachlorobutadiene	1,2-Dibromo-3-chloropropane
cis-1,2-Dichloroethene	Naphthalene	
n-Hexane	1,2,4-Trichlorobenzene	

#### **3.1.4.4 Olfactometry**

BAAQMD Regulation 7, Section 7-400 describes the District's in-house analysis methodology and procedure for completing odor panel analysis. A major difference between the Section 7-400 methodology and the industry standard ASTM E679-04 standard is the presentation rate. Regulation 7, Section 7-400 uses a presentation rate of 14 L/min while ASTM E679-04 uses 20 L/min. Based on published research results of different presentation rates, a presentation rate of 20 L/min has been proven to provide best accurate and reproducible results. Therefore, the ASTM E679-04 methodology was recommended for this effort.

Odor concentration by olfactometry followed ASTM E679-04 Standard of Practice with a presentation rate of 20 L/min (per EN 13725) using St. Croix Sensory, Inc.'s odor panel analyses. Samples were collected in 10-L Tedlar bags. Results determine the magnitude of odor emissions from each source and the relative offensiveness of odors from each source. Odor panel analysis report odor concentrations expressed as D/T, recognition threshold, odor offensiveness as measured by hedonic tone (the degree to which an odor is perceived as pleasant or unpleasant), and odor character descriptors.

The odor samples are diluted to below olfactory detection limits and then introduced to a gas delivery system. A panel of eight members trained in odor response serves as the odor "detector." Panel members are asked to smell air samples delivered to one of three nose cones (the other nose cones have clean air), one of which has the diluted sample. The concentrations of sample are increased until one-half of the odor panel members can detect the odor. The odor measurement is concluded when detection by four of the eight panel members is recorded. The odor concentration is expressed as the number of dilutions that are required for one-half of the panel members to record detection: D/T level.

Odor intensity is determined in accordance with ASTM Method E544-104. ASTM Method E544 is the standard reference method most widely used for quantifying odor intensity. This method references the odor intensity of an odor sample to eight concentrations of a reference odorant, n-butyl alcohol (butanol), ranging between approximately 15 and 200 parts per million by volume (ppmv) in air. Butanol has a unique ability to provide varying intensities with concentrations that are easily identifiable to most populations. Thus, the intensity level (or sensation) of any odorous substance can be compared to this constant rating system. The butanol scale concentrations represent different intensities ranging from slightly above threshold (1) to very strong (8). Reported intensity values are related to known concentrations of n-butanol in air or water. The higher the reported concentration, the greater the perceived intensity of the odor. Although odor intensity results are not used in the modeling of odor emission sources, the relative intensity levels for different D/T concentrations were compared for each process area odor type.

#### **3.1.5 Field Surveys/Measurements**

The field surveys and measurements included field odor assessments, field hydrogen sulfide measurements, and continuous hydrogen sulfide data logging. These activities are described in the following sections.

##### **3.1.5.1 Field Odor Assessments**

Jacobs deployed a two-person team for the field odor assessments to quantify the relative odor impact in the neighboring communities and the relative odor strength of the different odors emitted from a facility. The team used a field olfactometer that allows quantification of odors in the field. The field olfactometer uses a similar methodology as an olfactometer used in the lab to quantify odors according to the standard ASTM method (ASTM E679) and is designed to provide accurate in-field odor measurement of ambient air. Field olfactometry was completed using the Scentroid SM100. The unit measures odor in D/T. The unit measurement range is 2 to 15,000 D/T. Operation of the SM100 was completed in the presence of a trained odor control engineer.

The team walked the areas in neighboring communities, the perimeter of each facility, and the surrounding area. Field odor monitoring was performed during sensitive periods of the day when the facilities are operating regularly. The field effort consisted of the following steps:

- 1) Team members walking around the targeted area.
- 2) Team members using their noses to detect any odors.
- 3) When odor was detected and confirmed by a second team member, the following equipment was used:
  - a) Wind meter (to collect wind direction and wind speed data).
  - b) Scentroid SM100.
- 4) Each time odor was detected, the following field parameters were recorded in the field form provided in Appendix A:
  - a) Location and time.
  - b) Wind direction and velocity.
  - c) Weather conditions: Sunny (1), Partly Cloudy (2), Mostly Cloudy (3), Overcast (4), Hazy (5).
  - d) Precipitation: None (1), Fog (2), Light Rain (3), Rain (4).
  - e) Odor strength: Field olfactometry with the Scentroid SM100 to quantify odor strength at specific locations. The instrument is designed for measuring and quantifying odor strength in ambient air.
  - f) Odor characterization:
    - i. Odor descriptors: What does it smell like? For example, earthy, musty, metallic, ammonia, sour, using an odor descriptor wheel as a referencing vocabulary for odor descriptors.
    - ii. Intensity: How strong is the smell? Not Detectable (0), Very Weak (1), Weak (2), Distinct (3), Strong (4), Very Strong (5), Extremely Strong (6).
    - iii. Hedonic Tone: How pleasant is the smell? Pleasant (1), Neutral (0), Unpleasant (-1), Revolting (-2), Nauseating (-3).

Specific walking routes by individual team members were conducted randomly to document locations with and without any odor to be correlated with observed meteorological conditions (data obtained from the portable wind meter and was compared to the data obtained from the closest Bureau of Meteorology meteorological station). Individual team members walked in the target area as well as upwind of the different sources at the facility from certain sampling locations to determine where else odors could be detected, where odors would possibly originate from, and to correlate them with observed conditions.

Prior to completing an olfactometer survey, a portable weather station was used to collect meteorological data including temperature, wind direction, wind velocity, and wind gust. The weather station was set up in an area where the wind is unobstructed and as close to the location of the survey as possible. The unit was mounted 4 to 6 feet above the ground using an appropriate weather station tripod. In addition, observational data was recorded for weather conditions (sunny, partly cloudy, and similar) and precipitation (fog, rain, and similar). This information is recorded in the field form (Appendix A).

### 3.1.5.2 Field Hydrogen Sulfide and Ammonia

Field measurements for H<sub>2</sub>S and ammonia were made using Gastec or Draeger colorimetric tubes and handheld Jerome hydrogen sulfide meters. This type of field real-time sampling was completed during each sampling event at each sampling location. H<sub>2</sub>S measurements were made in ambient air and from each sampling bag collected. This real-time field data was used to back up and cross check more sophisticated laboratory analysis conducted on odorous air bag samples sent to the laboratory. It should be noted that some degradation of odors



can occur within the first 24 hours after bag collection. Hence, by providing real-time field measurements, more accurate levels of certain odors can be achieved.

**Colorimetric tubes:** The tube was interfaced to the testing point of interest, and a handpump calibrated to pull 100 mL to draw the air sample through the tube. The advance of the color change on the calibrated tube barrel indicated the compound (such as H<sub>2</sub>S, ammonia, and similar) concentration.

**Jerome 631-X handheld analyzer:** This instrument is factory calibrated and has a working range of 1 to 50,000 ppbv. It was used to detect other reduced sulfur compounds at about 10 percent of the sensitivity compared to H<sub>2</sub>S.

### 3.1.5.3 Continuous Hydrogen Sulfide Monitoring

Acrulog continuous data logging units were deployed in specific locations to measure H<sub>2</sub>S levels over a continuous time span. The duration of logging ranged between one and two weeks depending on the location, and readings were taken and logged once every 10 minutes. This continuous data logging was conducted to capture diurnal trends and assist in determining the best time of the day to obtain grab samples or to help establish diurnal odor emission rates.

## 3.2 Sampling Event Summary

This section consists of a summary of the four sampling events in chronological order.

### 3.2.1 Sampling Event 1 – Fall 2020

#### 3.2.1.1 Description

The sampling event took place during the week of October 19 to 22, 2020. The planned sampling schedule was as follows:

- Monday: Samples were collected at ZWED facility and field odor assessments conducted in neighboring communities and upwind of ZWED
- Tuesday: Samples were collected at San José-Santa Clara RWF and field odor assessments conducted in neighboring communities and upwind of RWF
- Wednesday: Samples were collected at NIRRP and field odor assessments conducted in neighboring communities and upwind of NIRRP
- Thursday: Samples were collected from facility downwind locations

Two sampling teams were deployed: one for collection of samples within facilities, referred to as the Field Sampling Team; and one for conducting field measurements and surveys, referred to as the Surveying Team.

Weather:

- Morning light winds out of the southeast
- Afternoon stable winds out of the northwest
- Temperature: High: 86°F and Average Daily: 65°F

The sampling matrix for this event is shown in Table 3-5.

Table 3-5. Sampling Matrix for Sampling Event 1

Sampling Set	Source ID	Source	Number of Samples per event	Odor Constituent, Sample Collection, and Sample Analysis Method											
				OPM	Reduced Sulfur	Olfactometry Laboratory (OU/m <sup>3</sup> )	Aldehyde	Amines	VOCs <sup>a</sup>	Carboxylic Acid	Ammonia	Spot H <sub>2</sub> S	H <sub>2</sub> S	Continuous H <sub>2</sub> S	Olfactometer Field (D/T)
				10-L Teflon Bag	1-L Tedlar Bag <sup>d</sup>	10-L Teflon Bag	Sorption Tubes	Sorption Tubes	Sorption Tubes	Sorption Tubes	In-field	In-field	In-field	In-field	In-field
				Modified Standard Method 2170: Flavor Profile Analysis Method (applied to air)	ASTM D5504 Method by Modified GC/SCD with sulfur chemiluminescence	ASTM E679-04 Standard of Practice with a presentation rate of 20 liters per minute (per EN 13725)	TO -11A (EPA 1999)	ALS (sorbent tube) Method 101 (their unique standard method)	TO -17 (EPA 1999)	ALS (sorbent tube) Method 102 (their unique standard method)	Draeger tubes	Jerome Meter	Draeger tubes	OdaLog	Scentroid SM-100
RWF	1	East Primaries	1	X <sup>a</sup>	X	X	See Note <sup>h</sup>	See Note <sup>h</sup>	X	X	See Note <sup>h</sup>	X	See Note <sup>h</sup>	X	X
	2	Bioreactors	1	See Note <sup>e</sup>	X	X	See Note <sup>h</sup>	See Note <sup>h</sup>	X	See Note <sup>h</sup>	See Note <sup>h</sup>	X	See Note <sup>h</sup>	See Note <sup>h</sup>	X
	3	Lagoons	1	See Note <sup>e</sup>	X	X	X	X	X	X	X	X	See Note <sup>h</sup>	See Note <sup>h</sup>	X
	4	Drying Beds	1	See Note <sup>e</sup>	X	X	X	X	X	X	X	X	See Note <sup>h</sup>	See Note <sup>h</sup>	X
	5	RWF Downwind	multiple	See Note <sup>h</sup>	See Note <sup>h</sup>	See Note <sup>h</sup>	See Note <sup>h</sup>	See Note <sup>h</sup>	See Note <sup>h</sup>	See Note <sup>h</sup>	See Note <sup>h</sup>	See Note <sup>h</sup>	See Note <sup>h</sup>	See Note <sup>h</sup>	X
ZWED	6	ZWED Interior Space	1	X <sup>a</sup>	X	X	X	X	X	X	X	X	See Note <sup>h</sup>	X	X
	7	Biofilter 1	1	See Note <sup>e</sup>	X	X	X	X	X	X	X	X	See Note <sup>h</sup>	X	X
	8	Pressure Relief Valve/Gas Holder Carbon Unit	multiple	See Note <sup>h</sup>	See Note <sup>h</sup>	See Note <sup>h</sup>	See Note <sup>h</sup>	See Note <sup>h</sup>	See Note <sup>h</sup>	See Note <sup>h</sup>	See Note <sup>h</sup>	See Note <sup>h</sup>	See Note <sup>h</sup>	X <sup>f</sup>	X <sup>f</sup>
	9	ZWED Downwind	multiple	See Note <sup>h</sup>	See Note <sup>h</sup>	See Note <sup>h</sup>	See Note <sup>h</sup>	See Note <sup>h</sup>	See Note <sup>h</sup>	See Note <sup>h</sup>	See Note <sup>h</sup>	See Note <sup>h</sup>	See Note <sup>h</sup>	See Note <sup>h</sup>	X
NIRRP	10	Landfill Working Face	1	X <sup>a</sup>	X	X	X	X	X	X	See Note <sup>h</sup>	X	See Note <sup>h</sup>	See Note <sup>h</sup>	X
	11	Compost Piles and/or Green Waste Facility and/or Curing Piles <sup>c</sup>	1	X <sup>a</sup>	X	X	X	X	X	X	X	X	See Note <sup>h</sup>	See Note <sup>h</sup>	X
	12	MRF	1	See Note <sup>e</sup>	X	X	X	X	X	X	See Note <sup>h</sup>	X	See Note <sup>h</sup>	See Note <sup>h</sup>	X
	13	Landfill Gas	1	X <sup>a</sup>	X	X	X	X	X <sup>b</sup>	X	See Note <sup>h</sup>	X	X	See Note <sup>h</sup>	See Note <sup>h</sup>
	14	Leachate Tanks	TBD	See Note <sup>h</sup>	See Note <sup>h</sup>	X <sup>g</sup>	See Note <sup>h</sup>	See Note <sup>h</sup>	See Note <sup>h</sup>	See Note <sup>h</sup>	See Note <sup>h</sup>	See Note <sup>h</sup>	See Note <sup>h</sup>	See Note <sup>h</sup>	X
	15	Landfill Downwind	multiple	See Note <sup>h</sup>	See Note <sup>h</sup>	See Note <sup>h</sup>	See Note <sup>h</sup>	See Note <sup>h</sup>	See Note <sup>h</sup>	See Note <sup>h</sup>	See Note <sup>h</sup>	See Note <sup>h</sup>	See Note <sup>h</sup>	See Note <sup>h</sup>	X

Acronyms/Abbreviations:

D/T = dilutions to threshold  
 EN = European norm  
 OPM = Odor Profile Method  
 OU/m<sup>3</sup> = odor units per cubic meter  
 TBD = to be determined

Notes:

- <sup>a</sup> Duplicate samples to be sent to both UCLA to perform the OPM and generate persistency curves and Montrose to perform an initial scan to identify the wide range of individual compounds and specific markers of these odor sources.
- <sup>b</sup> Analyzed also for methane concentrations.
- <sup>c</sup> Field olfactometer surveys will be used to get a reading of odor intensity and the team will have the flexibility to adjust strategy to include green waste feedstock sampling depending on field conditions as needed.
- <sup>d</sup> BAAQMD does not allow use of Tedlar bags for TRS analysis. Sulfur poses challenges with regards to sample bag material as it decays in Tedlar bags and diffuses in Teflon bags. If samples will be analyzed within appropriate holding time (24 hours in this case), these materials may be acceptable for the first sampling event, which is designed to be a screening event.
- <sup>e</sup> A single 10-liter bag or four 1-liter samples delivered to UCLA for OPM only (no persistency curves).
- <sup>f</sup> Field observance will dictate if the PRV or gas holder carbon unit is sampled.
- <sup>g</sup> Leachate tanks will be observed on the day of sampling and if odorous limited samples will be collected.
- <sup>h</sup> Specific analysis/method not performed. Only analyses/methods deemed necessary for the specific source (i.e., matching expected odorant emissions or considered non-redundant to other analyses/methods listed) are to be performed. Analysis selection based on past studies, best engineering judgment, project budget restraints, or based on the particular source categorized as either critical or non-critical. For example, leachate tanks inherently exhibit a small emissions plume, are unlikely to impact significantly offsite, and are therefore considered a non-critical source. Similarly, RWF Downwind is expected to exhibit odor concentrations generally below reporting limits and therefore preclude the need for comprehensive sulfur analysis (i.e., ASTM D5504).

### 3.2.1.2 Observations

The first odor sampling event was originally planned for late August/early September 2020. Due to the historic wildfires that resulted in severe/hazardous air quality for several weeks in September and both the associated health and safety issues and potential impact to the quality of the sampling results, it was agreed to delay the first sampling event. The weather conditions during the sampling event are believed to be representative of the warmer odor season, which met the intent of the first sampling event. Refer to Appendix E for field photos of this sampling event.

Sampling was completed as scheduled at the ZWED facility on Monday. The following key observations were made:

- The ZWED Interior Space odors were potent. Odors from this space were detected downwind of the facility.
- Biofilters emitted minimal odors, and these odors were typical of an organic biofilter.
- The activated carbon filter unit serving the biogas storage bladders had a burnt smell, possibly due to carbon disulfide. Minor H<sub>2</sub>S was detected in the sample. Initially, the activated carbon filter inlet pipe was not attached, and air was blowing untreated onto the roof. Facility staff then reconnected the inlet before odor sample collection. Air flow rate could not be gauged at this time.

Sampling was completed as scheduled at RWF on Tuesday. The following key observations were made:

- The primary effluent launders and the adjacent collection channel all exhibited turbulence that were believed to potentially contribute to the offsite odors.
- The bioreactors (for secondary treatment) generally exhibited fewer nuisance odors. However, one zone is a timed cycle between anoxic/aerobic and when the blowers were switched on, odors noticeably increased. Blowers were run for approximately two minutes every 10 minutes. To capture this event, Jacobs sampled in this basin.
- For the drying beds, Jacobs was unable to sample the wet beds that the facility staff were working on. Therefore, Jacobs sampled the beds that were waiting to be processed and minimal odors were observed from these.
- Sampling went as planned in the lagoons and typical odors were observed. The lagoons occupy a large area, potentially emitting a larger plume that may contribute to offsite impacts.
- UCLA received only one out of two boxes of samples on Wednesday from Tuesday's sample event. The second box arrived on Thursday. This exceeded the generally accepted sample hold time of 24 hours. Based on literature and past project experience, this delay was not believed to significantly impact results.

Sampling was completed as scheduled at NIRRP on Wednesday, except that the MRF sampling was pushed to Thursday. The MRF had a small fire on Wednesday and Jacobs was concerned about smoke-related odors impacting sampling results. Fire-fighting methods (e.g., water extinguishing) were not expected to have resulted in residual odor suppression. Odor emissions at the MRF are due to fresh material received, justifying moving forward with delayed sampling on Thursday. The following key observations were made:

- Composting piles have a bark/woodchip biolayer on top of them which suppress odor emissions; primarily only wood chip odors were observed in this area. Sampling was conducted on a compost pile which had aged for five days (a "day 5" compost pile).
- The biosolids stockpiling area exhibited minimal odors. However, given that it is a relatively large area, it could have potential for persistent odors.
- The working face of the landfill was a key odor source with constant waste deliveries (at least two to three trucks dumping waste throughout the day). NIRRP works to cover the waste as fast as they receive it, but

constant delivery means that there is always fresh waste exposed. Jacobs sampled right after the ZWED waste delivery was dropped off and before the waste was compressed and buried. For safety reasons, a subsidiary working face was created for sampling purposes. The waste stream received at the subsidiary working face was exclusively ZWED residuals, simulating the main working face area dedicated to receiving ZWED residuals. Other areas of the main working face are generally observed to receive less odorous waste, making the subsidiary working face sampling results more conservative.

Sampling was conducted and completed successfully at the MRF and downwind locations on Thursday. The following key observations were made:

- The MRF was not a significant odor source compared to the working face of the landfill. However, because it is so close to the property line, these odors may contribute to the offsite impacts.
- Jacobs took a single bag sample from the leachate tanks for OPM analysis but did not notice leakage or odors from these tanks.
- Sampling at the downwind locations had to be delayed by a few hours due to the southerly wind direction and low wind speed. Jacobs waited until a northwest wind was observed, which was around noon to start collecting samples, because this was more representative of typical conditions.
  - Both ZWED and NIRRP were sampled at the southeast corner (the northwest wind was generally stable during the entire sampling event) and had notable odors during the entire sampling event.
  - At the RWF, Jacobs sampled just south of the secondary clarifiers and bioreactors. It was difficult to obtain a sample under stable wind direction and speed conditions, but the wind direction was generally observed to be out of the northwest. There was some concern that this location might not be as representative as the other sources due to the varied winds and because only infrequent observations of the downwind odors from primaries/bioreactors were observed.
  - Jacobs sampled the Milpitas Lift Station just outside of the fence near the southeast corner near the road. The northwest wind was moderately stable during the sampling and typical pump station odors were observed.

### 3.2.1.3 Laboratory Analytical Results

Laboratory analytical results are summarized in the following tables and figures. The laboratory reports are included in Appendix B. Appendix F provides a summary of concentration to mass loading conversions for key constituents.

#### 3.2.1.3.1 Reduced Sulfur Compound Analysis (ASTM D5504) Results

Reduced sulfur compound laboratory analytical results are summarized in Table 3-6 for ZWED, RWF, and NIRRP. The RWF in general exhibited the greatest concentration levels for sulfur compounds with the exception of the NIRRP landfill gas, which was expected.

**Table 3-6. Sampling Event 1 Reduced Sulfur Compound Analytical Results**

Location	Reduced Sulfur Compounds (ppbv) <sup>a</sup>							
	CDS	CS	DMDS	DMS	H <sub>2</sub> S	MM	PM	BM
<b>ZWED</b>								
Interior Space	7.6	6.3	7.3	ND	24	32	ND	ND
Biofilter 1	9.5	9.1	9.5	22	7.6	7.3	ND	ND

Location	Reduced Sulfur Compounds (ppbv) <sup>a</sup>							
	CDS	CS	DMDS	DMS	H <sub>2</sub> S	MM	PM	BM
Activated Carbon Filter	5.6	ND	ND	ND	16	ND	ND	ND
<b>RWF</b>								
East Primaries	71	68	ND	57	29,000	1,100	ND	13
Bioreactors	93	31	15	51	240	690	ND	6.4
Lagoons	ND	ND	ND	ND	9.6	ND	ND	ND
Drying Beds	ND	ND	ND	ND	18	ND	ND	ND
<b>NIRRP</b>								
Landfill Working Face	ND	ND	ND	ND	21	ND	ND	ND
Compost Piles	ND	ND	ND	10	16	ND	ND	ND
MRF	ND	ND	ND	ND	19	ND	ND	ND
Landfill Gas	1,900	6,100	300	37,000	4,500,000	35,000	1,100	ND
Cake Stockpile	38	24	13	42	10	ND	ND	ND

Notes:

<sup>a</sup> Per ASTM D 5504. Only those compounds measured (i.e., above Method Reporting Limit) are shown.

ND = non-detect, CDS = carbon disulfide, CS = carbonyl sulfide, DMDS = dimethyl disulfide, DMS = dimethyl sulfide, MM = methyl mercaptan, PM = n-propyl mercaptan, BM = tert-butyl mercaptan

### 3.2.1.3.2 General Odor Analysis (ASTM E769-04) Results

Odor panel analysis results are summarized in Table 3-7 for ZWED, RWF, and NIRRP. The East Primaries and the landfill gas exhibited the highest general odor concentrations. Furthermore, the most offensive source (most negative hedonic tone [HT]) was the bioreactors which was somewhat surprising.

**Table 3-7. Sampling Event 1 General Odor Laboratory Results**

Sample Description	D/T	RT	I	HT	DR	Comments
Interior Space	1,400	710	4.0	-2.3	---	
Biofilter 1	980	510	4.0	-2.2	---	
Activated Carbon Filter	1,400	770	4.7	-2.6	---	
East Primaries	>60,000	>60,000	---	---	---	RT>50,000. Sample not observed for Intensity, Characterization, or Persistency evaluations.
Bioreactors	9,100	4,700	4.3	-3.0	---	
Lagoons	550	310	3.9	-2.0	---	
Drying Beds	220	110	3.7	-1.6	---	
Landfill Working Face	1,100	640	4.8	-2.9	---	
Compost Piles	300	180	3.8	-2.3	---	
MRF	140	95	2.7	-1.2	---	

Sample Description	D/T	RT	I	HT	DR	Comments
Landfill Gas	>60,000	>60,000	---	---	---	RT>50,000. Sample not observed for Intensity, Characterization, or Persistency evaluations.
Cake Stockpile	2,700	1,700	5.1	-2.7	---	

Notes:

DR = dilution ratio; HT = hedonic tone; I = intensity; RT = recognition to threshold

The figures below depict the average sensation of the odor descriptors (on a scale 1 to 10). The following are general findings associated with the results:

- The ZWED interior and biofilter both exhibited similar odors including dairy (i.e., rancid) and decay (i.e., sulfur/fecal).
- The ZWED activated carbon filter exhibited relatively high odors including rotten vegetable (i.e., reduced organic sulfur compounds) and herbal.
- The RWF bioreactors exhibited moderate odors including decay (i.e., sulfur/fecal) and rotten vegetable (i.e., reduced organic sulfur compounds).
- The RWF lagoons exhibited moderate odors including a combination of decay (i.e., sulfur/fecal) and earthy.
- The RWF drying beds exhibited moderate odors including a combination of decay (i.e., sulfur/fecal) and earthy.
- NIRRP landfill gas exhibited strong odors in several nuisance categories including decay and dairy (i.e., rancid).
- NIRRP compost exhibited a moderate earthy odor, which tends to be less offensive.
- The MRF exhibited minor odors with less of a nuisance characteristic.
- NIRRP cake exhibited strong earthy odors, which tend to be less offensive.

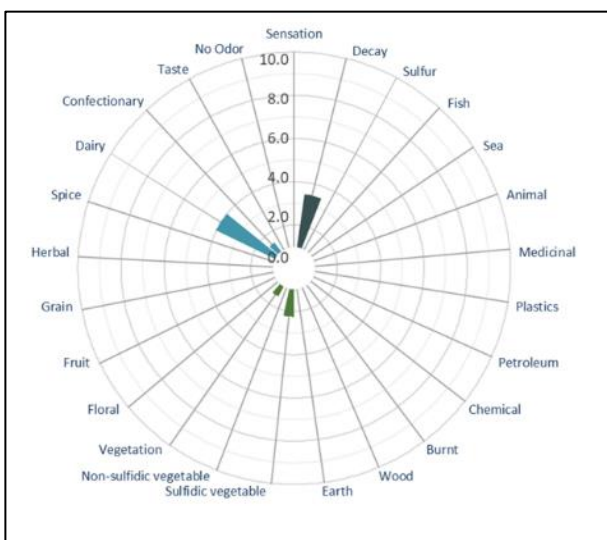

Figure 3-4. Odor Descriptors for ZWED Interior

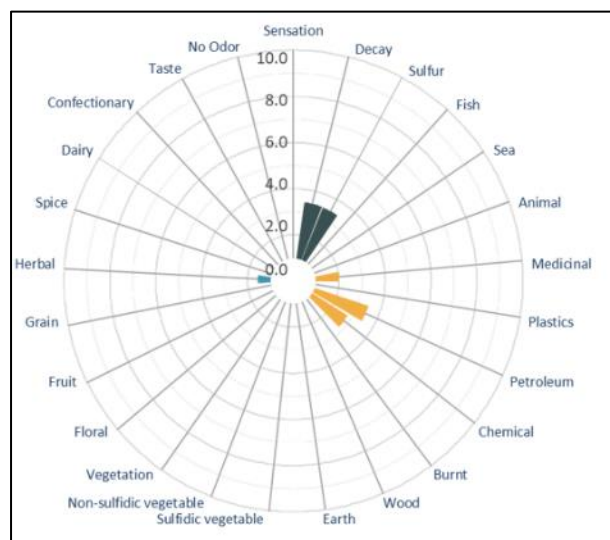

Figure 3-5. Odor Descriptors for ZWED Biofilter 1

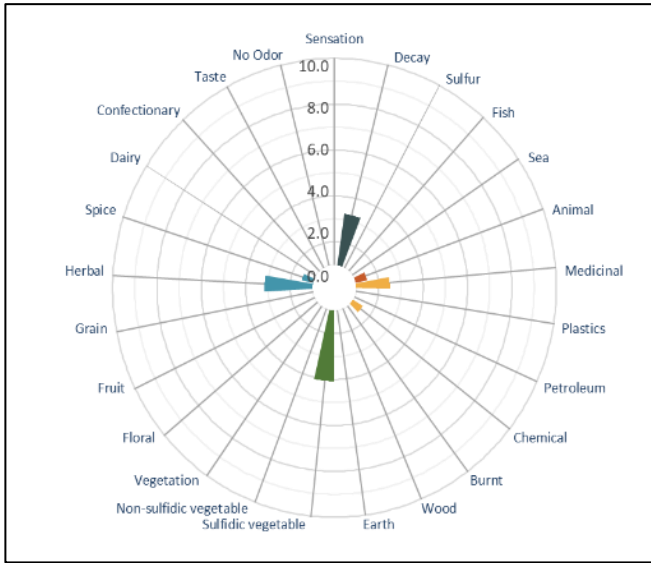

Figure 3-6. ZWED Activated Carbon Filter

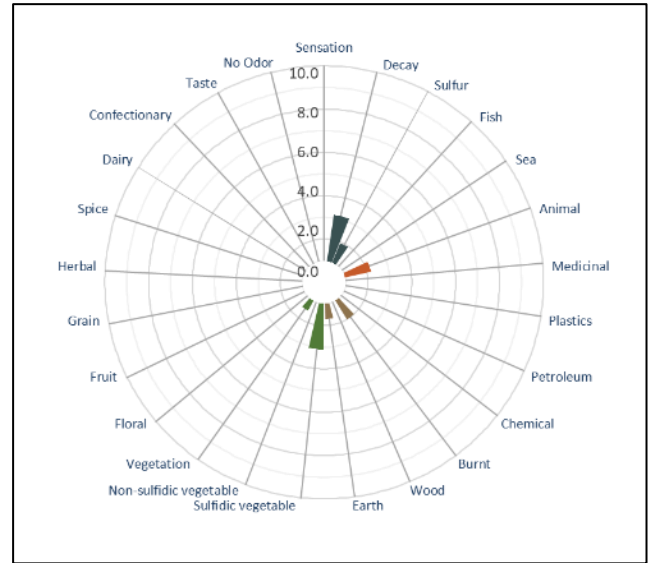

Figure 3-7. RWF Bioreactors

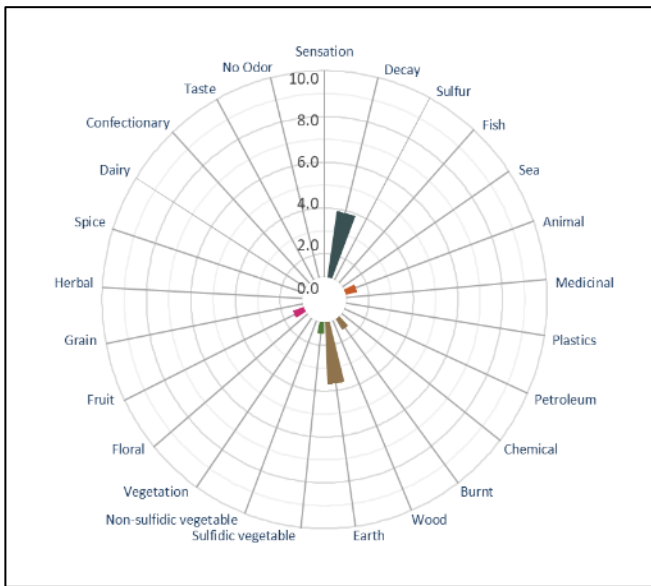

Figure 3-8. Odor Descriptors for RWF Lagoons

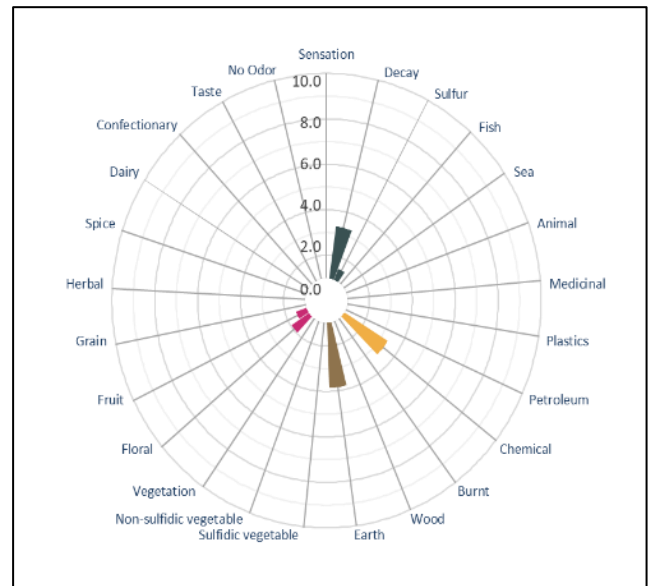

Figure 3-9. Odor Descriptors for RWF Drying Beds

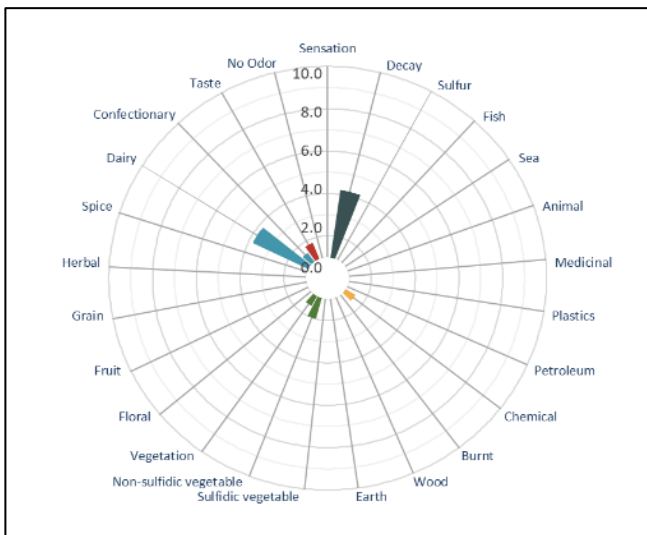

Figure 3-10. Odor Descriptors for NIRRP Landfill Working Face

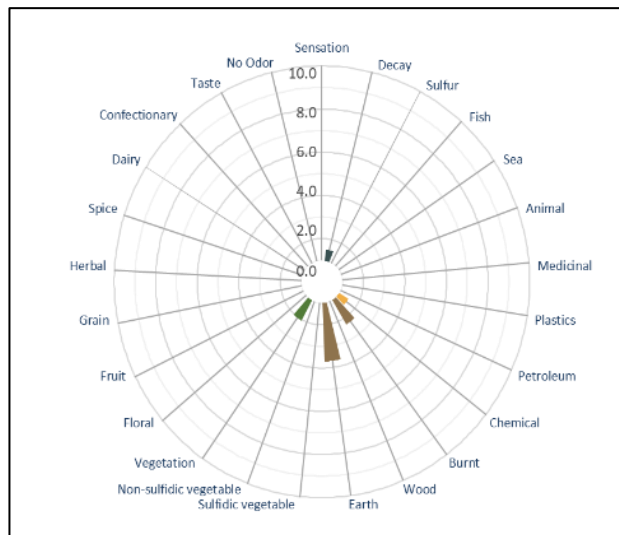

Figure 3-11. Odor Descriptors for NIRRP Compost Piles

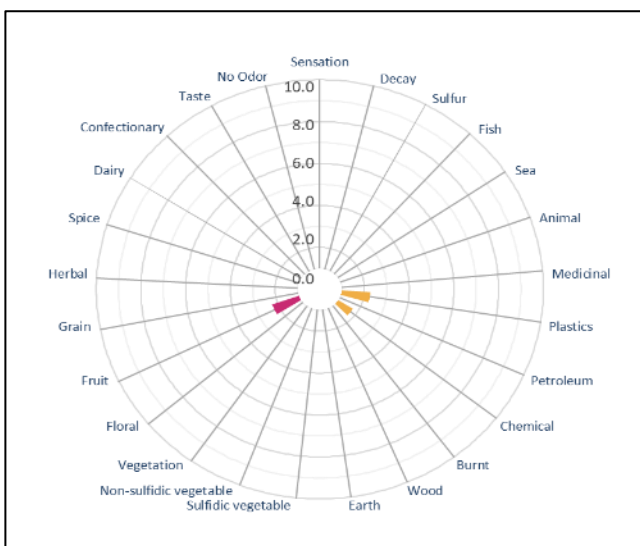

Figure 3-12. Odor Descriptors for NIRRP MRF

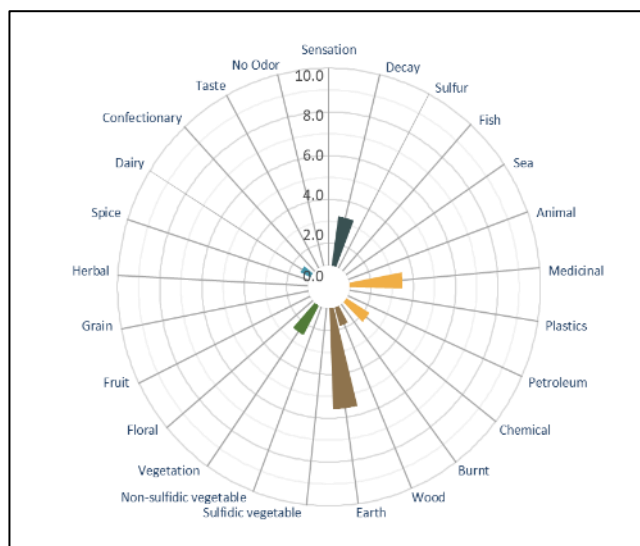

Figure 3-13. Odor Descriptors for NIRRP Cake Stockpile

### 3.2.1.3.3 Aldehyde Analysis (TO-11A) Results

Aldehyde analytical results are summarized in Table 3-8 for ZWED, RWF, and NIRRP. Significant levels of aldehydes were found at only three sources - the ZWED interior space, the NIRRP working face, and NIRRP landfill gas. Other sources exhibited either no aldehydes or only a small number or concentration of aldehydes.



**Table 3-8. Sampling Event 1 Aldehyde Analytical Results**

Location	Aldehydes (ppbv) <sup>a</sup>								
	F	A	P	BY	BZ	I	V	T	H
<b>ZWED</b>									
Interior Space	50	260	3.4	2.6	0.53	2	0.41	0.54	2
Biofilter 1	7.7	10	ND	ND	ND	ND	ND	ND	ND
<b>RWF</b>									
Lagoons	ND	ND	ND	ND	ND	ND	ND	ND	ND
Drying Beds	ND	4.6	ND	ND	ND	ND	ND	ND	0.74
<b>NIRRP</b>									
Landfill Working Face	170	820	13	6.9	2.3	5.6	0.67	0.39	3.4
Compost Piles	ND	4.4	ND	ND	ND	ND	ND	ND	ND
MRF	4.9	7.7	ND	ND	ND	ND	ND	ND	0.42
Landfill Gas	13	300	110	140	ND	26	75	ND	15
Cake Stockpile	2.9	5.4	ND	0.59	ND	0.77	ND	ND	0.43

Notes:

<sup>a</sup> Per TO-11A. Only those compounds measured (i.e., above Method Reporting Limit) are shown.

ND = non-detect, F = formaldehyde, A = acetaldehyde, P = propionaldehyde, BY = butyaldehyde, BZ = benzaldehyde, I = isovaleraldehyde, V = valeraldehyde, T = o-tolualdehyde, H=n-hexaldehyde

### 3.2.1.3.4 Carboxylic Acid Analysis (ALS Method 102) Results

Carboxylic acid analytical results are summarized in Table 3-9 for ZWED, RWF, and NIRRP. Significant levels of carboxylic acids were found at only three sources - the ZWED interior space, the NIRRP working face, and NIRRP landfill gas. Other sources exhibited either no carboxylic acids or only a small number or concentration of carboxylic acids.

**Table 3-9. Sampling Event 1 Carboxylic Acid Analytical Results**

Location	Carboxylic Acids (ppbv) <sup>a</sup>									
	A	P	2-MP	B	2-MB	3-MB	PN	4-MP	H	E
<b>ZWED</b>										
Interior Space	920	150	10	92	4.9	6.5	16	3.3	10	0.76
Biofilter 1	ND	ND	ND	ND	ND	ND	ND	ND	ND	ND
<b>RWF</b>										
Lagoons	ND	ND	ND	ND	ND	ND	ND	ND	ND	ND
Drying Beds	ND	ND	ND	ND	ND	ND	ND	ND	ND	ND

Location	Carboxylic Acids (ppbv) <sup>a</sup>									
	A	P	2-MP	B	2-MB	3-MB	PN	4-MP	H	E
<b>NIRRP</b>										
Landfill Working Face	240	46	13	37	3.7	7.3	3.5	ND	6	1.5
Compost Piles	ND	ND	ND	ND	ND	ND	ND	ND	ND	ND
MRF	16	1.4	ND	ND	ND	ND	ND	ND	ND	ND
Landfill Gas	390	300	140	2,200	42	92	400	31	1,000	12
Cake Stockpile	17	2.3	2.8	ND	ND	1.8	ND	ND	ND	ND

Notes:

<sup>a</sup> Per TO-11A. Only those compounds measured (i.e., above Method Reporting Limit) are shown.

ND = non-detect, A = acetic acid, P = propionic acid, 2-MP = 2-methylpropanoic acid, B = butanoic acid, 2-MB = 2-methylbutanoic acid, 3-MB = 3-methylbutanoic acid, PN = pentanoic acid, 4-MP = 4-methylpentanoic acid, H = hexanoic acid, E = 2-ethylhexanoic acid

### 3.2.1.3.5 Amine Analysis (ALS Method 101) Results

Amine analysis results are summarized in Table 3-10 for ZWED, RWF, and NIRRP. Only trimethyl amine (TMA) was detected and it was found at the landfill working face. It should be noted that TMA has a very low odor threshold concentration (OTC) and is therefore often a significant odorant.

**Table 3-10. Sampling Event 1 Amine Analytical Results**

Location	Amines (ppbv) <sup>a</sup>
	T
<b>ZWED</b>	
Interior Space	ND
Biofilter 1	ND
<b>RWF</b>	
Lagoons	ND
Drying Beds	ND
<b>NIRRP</b>	
Landfill Working Face	9.4
Compost Piles	ND
MRF	ND
Landfill Gas	ND
Cake Stockpile	ND

Notes:

<sup>a</sup> Per TO-11A. Only those compounds measured (i.e., above Method Reporting Limit) are shown.

ND = non-detect, T = trimethylamine

### 3.2.1.3.6 Ammonia Analysis (OSHA ID-188 Method) Results

Ammonia analysis results are summarized in Table 3-11 for ZWED, RWF, and NIRRP. Ammonia was detected at several sources. However, because the OTC for ammonia is greater than 1 part per million (ppm), the values in this table are considered negligible from an odor impact standpoint.

**Table 3-11. Sampling Event 1 Ammonia Analytical Results**

Location	Ammonia (ppbv)
<b>ZWED</b>	
Interior Space	1
Biofilter 1	8
Activated Carbon Filter	<1
<b>RWF</b>	
Lagoons	30
Drying Beds	<0.01
<b>Newby</b>	
Landfill Working Face	9
Compost Piles	<0.01
Landfill Gas	2.5
Cake Stockpile	<1

### 3.2.1.3.7 VOC Analysis (TO-17) Results

VOC analysis results are summarized in Table 3-12 through Table 3-18 for ZWED, RWF, and NIRRP. Multiple VOCs were detected at most sources. However, only a few sources exhibited high concentrations that approached the respective OTC. It should be noted that in almost every case, the measured concentrations fell below the respective OTC and therefore VOCs are considered less impactful when compared to other odorant groupings analyzed.

**Table 3-12. Sampling Event 1 VOC Analytical Results (1 of 7)**

Location	VOCs (ppbv) <sup>a</sup>								
	CFC-12	CM	CFC-114	VC	1,3-B	CE	E	An	Ac
<b>ZWED</b>									
Interior Space	0.52	0.84	ND	ND	ND	5.9	6,400	58	210
Biofilter 1	0.37	0.31	ND	ND	1.0	0.081	11	12	34
Activated Carbon Filter	ND	ND	ND	ND	ND	ND	ND	ND	ND
<b>RWF</b>									
East Primaries	0.32	0.44	ND	ND	ND	ND	29	10	4.7
Bioreactors	0.37	0.43	ND	ND	ND	ND	11	2.8	5.3
Lagoons	ND	ND	ND	ND	ND	ND	3.1	11	0.99
Drying Beds	0.16	0.40	ND	ND	ND	0.11	3.6	9.7	3.7

Location	VOCs (ppbv) <sup>a</sup>								
	CFC-12	CM	CFC-114	VC	1,3-B	CE	E	An	Ac
<b>NIRRP</b>									
Landfill Working Face	0.24	0.32	ND	ND	0.65	1.2	4,700	78	1,100
Compost Piles	0.16	0.096	ND	ND	ND	ND	2.5	0.42	1.3
MRF	0.45	0.14	ND	ND	ND	ND	19	28	8.4
Landfill Gas	110	ND	17	86	ND	140	20,000	710	8,200
Cake Stockpile	ND	0.26	ND	ND	ND	0.16	17	30	4.7

Notes:

<sup>a</sup> Per TO-11A. Only those compounds measured (i.e., above Method Reporting Limit) are shown.

ND = non-detect, CFC-12 = dichlorodifluoromethane, CM = chloromethane, CFC-114 = 1,2-dichloro-1,1,2,2-tetrafluoroethane (CFC 114), VC = vinyl chloride, 1,3-B = 1,3-butadiene, CE = chloroethane, E = ethanol, An = acetonitrile, Ac = acetone

**Table 3-13. Sampling Event 1 VOC Analytical Results (2 of 7)**

Location	VOCs (ppbv) <sup>a</sup>								
	TCFM	2-P	MC	TCTF	CD	1,2-D	1,1-D	M t-BE	2-B
<b>ZWED</b>									
Interior Space	0.23	130	0.27	0.088	5.1	ND	ND	ND	81
Biofilter 1	0.19	0.44	0.45	0.071	1.4	ND	ND	ND	13
Activated Carbon Filter	ND	ND	ND	ND	ND	5.6	ND	ND	ND
<b>RWF</b>									
East Primaries	0.17	0.85	1.1	0.22	4.9	ND	ND	ND	2.0
Bioreactors	0.10	0.39	0.27	0.18	2.1	ND	ND	ND	2.0
Lagoons	ND	0.20	0.045	ND	ND	ND	ND	ND	0.12
Drying Beds	0.08	ND	0.14	0.041	ND	ND	ND	ND	0.27
<b>NIRRP</b>									
Landfill Working Face	0.16	180	6.1	0.045	ND	ND	ND	ND	65
Compost Piles	ND	ND	ND	ND	10	ND	ND	ND	ND
MRF	0.16	1.9	0.083	0.082	ND	ND	ND	ND	3.7
Landfill Gas	21	3,100	76	0.86	1,600	25	10	2.9	ND
Cake Stockpile	ND	0.35	ND	ND	ND	ND	ND	ND	1.8

Notes:

<sup>a</sup> Per TO-11A. Only those compounds measured (i.e., above Method Reporting Limit) are shown.

ND = non-detect, TCFM = trichlorofluoromethane, 2-P = 2-propanol, MC = methylene chloride, TCTF = trichlorotrifluoroethane, CD = carbon disulfide, 1,2-D = trans-1,2-dichloroethene, 1,1-D = 1,1-dichloroethane, M t-BE = methyl tert-butyl ether, 2-b = 2-butanone

**Table 3-14. Sampling Event 1 VOC Analytical Results (3 of 7)**

Location	VOCs (ppbv) <sup>a</sup>								
	1,2-DC	n-Hx	CF	THF	1,2-DC	1,1,1-TCE	Bz	CTC	CHx
<b>ZWED</b>									
Interior Space	ND	1.8	0.20	0.22	0.10	ND	0.49	0.051	0.49
Biofilter 1	ND	1.3	0.16	0.57	0.29	ND	0.89	0.041	1.2
Activated Carbon Filter	ND	ND	ND	ND	ND	ND	ND	ND	ND
<b>RWF</b>									
East Primaries	0.078	2.1	0.96	0.099	ND	ND	1.3	0.059	0.56
Bioreactors	ND	3.1	0.94	ND	ND	ND	1.0	ND	0.68
Lagoons	ND	ND	ND	ND	ND	ND	0.14	ND	ND
Drying Beds	ND	0.15	ND	ND	ND	0.32	0.039	ND	ND
<b>NIRRP</b>									
Landfill Working Face	ND	9.9	0.24	15	1.7	0.056	1.2	ND	31
Compost Piles	ND	0.28	ND	ND	ND	ND	0.25	ND	ND
MRF	ND	0.66	ND	0.60	ND	ND	0.77	0.074	0.35
Landfill Gas	130	380	4.5	2,400	120	0.92	970	8.0	400
Cake Stockpile	ND	0.44	0.047	ND	ND	ND	0.48	ND	ND

Notes:

<sup>a</sup> Per TO-11A. Only those compounds measured (i.e., above Method Reporting Limit) are shown.

ND = non-detect, 1,2-DC = cis-1,2-dichloroethene, n-hexane, CF = chloroform, THF = tetrahydrofuran, 1,2-DC = 1,2-dichloroethane, 1,1,1-TCE = 1,1,1-trichloroethane, Bz = benzene, CTC = carbon tetrachloride, CHx = cyclohexane

**Table 3-15. Sampling Event 1 VOC Analytical Results (4 of 7)**

Location	VOCs (ppbv) <sup>a</sup>								
	1,2-DCP	BCM	TCE	1,4-Dx	2,2,4-TP	n-Hp	1,3-DCP	4M-2P	1,3-DCP
<b>ZWED</b>									
Interior Space	ND	0.038	0.09	ND	0.78	1.4	ND	1.2	ND
Biofilter 1	ND	0.08	0.039	0.06	1.6	1.7	ND	0.54	ND
Activated Carbon Filter	ND	ND	ND	ND	ND	ND	ND	ND	ND
<b>RWF</b>									
East Primaries	ND	0.29	0.35	0.21	0.56	1.0	ND	0.22	ND
Bioreactors	ND	0.20	0.32	ND	0.41	0.71	ND	0.26	ND
Lagoons	ND	ND	ND	0.043	ND	ND	ND	ND	ND
Drying Beds	ND	ND	ND	0.18	0.13	0.10	ND	ND	ND

Location	VOCs (ppbv) <sup>a</sup>								
	1,2-DCP	BCM	TCE	1,4-Dx	2,2,4-TP	n-Hp	1,3-DCP	4M-2P	1,3-DCP
<b>NIRRP</b>									
Landfill Working Face	0.49	0.89	0.069	1.6	68	12	ND	3.8	ND
Compost Piles	ND	ND	ND	ND	0.21	0.22	ND	ND	ND
MRF	ND	ND	ND	0.12	0.49	1.0	0.092	0.82	0.06
Landfill Gas	18	8.6	42	170	130	640	ND	940	ND
Cake Stockpile	ND	ND	ND	0.16	0.16	0.25	ND	0.63	ND

Notes:

<sup>a</sup> Per TO-11A. Only those compounds measured (i.e., above Method Reporting Limit) are shown.

ND = non-detect, 1,2-DCP = 1,2-dichloropropane, BCM = bromodichloromethane, TCE = trichloroethane, 1,4-Dx = 1,4-dioxane, 2,2,4-TP = trimethylpentane, n-Hp = n-heptane, 1,3-DCP = cis-1,3-dichloropropene, 4M-2P = 4-Methyl-2-pentanone, 1,3-DCP = trans-1,3-dichloropropene

**Table 3-16. Sampling Event 1 VOC Analytical Results (5 of 7)**

Location	VOCs (ppbv) <sup>a</sup>								
	T	2-Hx	DCM	1,2-DBM	n-Oc	TCE	CBz	EBz	m,p-X
<b>ZWED</b>									
Interior Space	18	ND	ND	ND	1.6	0.074	ND	1.5	4.7
Biofilter 1	5.6	0.47	ND	ND	0.53	0.18	0.13	1.4	7.4
Activated Carbon Filter	ND	ND	ND	ND	ND	ND	ND	ND	ND
<b>RWF</b>									
East Primaries	20	0.19	0.22	ND	0.72	0.35	ND	3.0	3.8
Bioreactors	25	ND	0.087	ND	0.91	0.32	ND	2.1	2.3
Lagoons	0.57	ND	ND	ND	0.047	ND	ND	0.04	0.088
Drying Beds	1.2	ND	ND	ND	0.092	ND	ND	0.12	0.36
<b>NIRRP</b>									
Landfill Working Face	56	ND	ND	ND	7.8	1.0	1.3	15	54
Compost Piles	1.1	ND	ND	ND	0.11	ND	ND	0.17	0.47
MRF	23	ND	ND	ND	0.6	0.068	ND	2.8	5.7
Landfill Gas	1,700	ND	ND	1.6	ND	ND	ND	ND	ND
Cake Stockpile	1.5	0.21	ND	ND	0.26	ND	2.6	0.16	0.69

Notes:

<sup>a</sup> Per TO-11A. Only those compounds measured (i.e., above Method Reporting Limit) are shown.

ND = non-detect, T = toluene, 2-Hx = 2-hexanone, DCM = dibromochloromethane, 1,2-DBM = dibromoethane, n-Oc = n-Octane, TCE = tetrachloroethane, CBz = chlotobenzene = EBz = ethylbenzene, m,p-X = m,p-xylenes

**Table 3-17. Sampling Event 1 VOC Analytical Results (6 of 7)**

Location	VOCs (ppbv) <sup>a</sup>								
	BF	St	o-Xy	1,1,2,2-TCE	Cu	1,3,5-TMB	1,2,4-TMB	1,3-DCB	1,4-DCB
<b>ZWED</b>									
Interior Space	ND	1.7	1.6	ND	0.093	0.34	1.1	ND	0.12
Biofilter 1	ND	0.69	2.7	ND	0.21	0.57	1.6	0.31	2.6
Activated Carbon Filter	ND	ND	ND	ND	ND	ND	ND	ND	ND
<b>RWF</b>									
East Primaries	0.13	0.40	1.6	0.04	0.23	0.67	1.8	0.071	0.40
Bioreactors	ND	0.30	0.95	ND	0.13	0.37	0.99	0.26	0.32
Lagoons	ND	ND	ND	ND	ND	0.031	0.083	0.063	ND
Drying Beds	ND	0.061	0.14	ND	ND	0.05	0.17	0.073	ND
<b>NIRRP</b>									
Landfill Working Face	ND	12	21	ND	0.78	2.9	8.1	0.12	1.8
Compost Piles	ND	0.34	0.17	ND	ND	0.054	0.16	ND	0.047
MRF	ND	2.6	1.9	0.057	0.20	0.34	1.1	ND	0.46
Landfill Gas	ND	ND	ND	36	ND	0.68	ND	160	ND
Cake Stockpile	ND	0.24	0.24	ND	ND	0.12	0.33	0.21	0.10

Notes:

<sup>a</sup> Per TO-11A. Only those compounds measured (i.e., above Method Reporting Limit) are shown.

ND = non-detect, BF = bromoform, St = styrene, o-Xy = o-xylene, 1,1,2,2-TCE = 1,1,2,2-tetrachloroethane, Cu = cumene, 1,3,5-TMB = 1,3,5-Trimethylbenzene, 1,2,4-TMB = 1,2,4-Trimethylbenzene, 1,3-DCB = 1,3-Dichlorobenzene, 1,4-DCB = 1,4-Dichlorobenzene

**Table 3-18. Sampling Event 1 VOC Analytical Results (7 of 7)**

Location	VOCs (ppbv) <sup>a</sup>	
	1,2,4-TCB	Na
<b>ZWED</b>		
Interior Space	ND	0.15
Biofilter 1	ND	0.11
Activated Carbon Filter	ND	ND
<b>RWF</b>		
East Primaries	0.13	0.13
Bioreactors	ND	0.11
Lagoons	ND	0.029
Drying Beds	ND	0.057

Location	VOCs (ppbv) <sup>a</sup>	
	1,2,4-TCB	Na
<b>NIRRP</b>		
Landfill Working Face	ND	0.048
Compost Piles	ND	0.84
MRF	ND	0.33
Landfill Gas	ND	1.0
Cake Stockpile	0.097	0.07

Notes:

<sup>a</sup> Per TO-11A. Only those compounds measured (i.e., above Method Reporting Limit) are shown.

ND = non-detect, 1,24-TCB = 1,2,4 trichlorobenzene, Na = naphthalene

### 3.2.1.4 Odor Profile Method Results

This section summarizes the OPM results including intensity values and persistency curves.

#### 3.2.1.4.1 OPM Intensity Results

Sampling Event 1 OPM intensity results are summarized in Table 3-19. As described in Section 3.1.4.2, an odorant's nuisance concentration is equivalent to an odor intensity value of 3. Intensity values greater than 3 should be considered a possible nuisance odor source. However, note that these values in many cases are measured directly at the source and therefore do not account for dilution from the source to the fence line. Key findings are as follows:

- Rancid (carboxylic acids), fecal, sweet (aldehyde), and rotten vegetables (reduced organic sulfur compounds) are all prevalent odorant types found.
- Musty odorants (e.g., 2-methyl isoborneol, 2-isopropyl-3-methoxypyrazine) were observed, but at lower intensity levels. Musty odorants are generally less offensive but can result in odor complaints depending on the sensitivity of the receptor.
- ZWED downstream exhibited high intensities characterized as rancid and sweet.

**Table 3-19. Sampling Event 1 OPM Intensity Values**

Location	Odor Characteristics and Intensities
ZWED Biofilter	fecal 5.5±2.5, rotten veg 4.5±5.3;
ZWED Interior Space	rancid 10.0±1.6, sweet 10.0±1.6;
ZWED Upwind	musty 1.0±1.2;
RWF East Primaries	rotten veg 5.0±5.8, fecal 4.0±4.9;
RWF Bioreactors	fecal 4.0±0.0, odor note: rotten veg
RWF Drying Beds	odor note: rotten veg, medicinal
RWF Upwind	No odor reported
NIRRP Compost Piles	musty 2.5±1.9, medicinal 1.0±1.2
NIRRP Landfill Working Face	rancid 7.5±2.5, sweet 7.5±2.5; odor note: fecal
NIRRP Cake Stockpile	musty 3.0±2.6; odor note: sweet rancid, chlorine



Location	Odor Characteristics and Intensities
NIRRP Landfill Gas	fecal 5.0±5.8, rotten veg 5.5±4.4; odor note: sweet rancid, medicinal
NIRRP Landfill Leachate	fecal 7.5±3.4, rancid 1.5±1.9, sweet 1.5±1.9;
MRF	odor note: fecal
NIRRP Upwind	No Odor Reported
ZWED Downwind	rancid 4.0±2.8, sweet 2.5+1.0; odor note: rotten veg
Main Pump Station	Odor note: rotten egg
NIRRP Island Downwind	Odor note: musty

### 3.2.1.4.2 Persistency Curves

Persistency curves for the various sources are provided on Figure 3-14 to Figure 3-23. As described in Section 3.1.4.2, OPM results are presented in persistency curves that show the log dilution to intensity with the odor character reported for each dilution. Persistency curves illustrate the “peeling the onion” phenomenon in which strong odors become diluted, revealing other previously masked odors which can be more persistent and problematic further downwind of the source. This illustrates how odor intensity and odor character changes when it travels from the different odor sources into the community.

The key findings from the persistency curves include:

- The ZWED biofilter source exhibited primarily fecal and rotten egg odorants with persistent musty odorants.
- The ZWED indoor source exhibited a combination of rancid and sweet odorants at high intensity levels with persistent musty odorants.
- The RWF primary effluent weirs and box source exhibited a combination of fecal and rotten egg odorants at high intensity levels, corroborating the analytical findings.
- The RWF aeration basin source exhibited primarily fecal odorants at moderate intensity levels.
- The NIRRP compost pile source exhibited primarily musty odorants at relatively mild intensities, corroborating the findings from the analytical findings.
- The NIRRP working face source exhibited primarily rancid and sweet at relatively high intensity levels, which agrees with the analytical findings previously discussed.
- The NIRRP landfill gas source was observed to be almost entirely rotten vegetable. This was likely due to the strength of this odorant type that likely masked other odorants known to exist from the various analytical testing results discussed previously.
- The NIRRP leachate source exhibited primarily fecal odorants at moderately high intensities.
- Downwind of ZWED revealed rancid and sweet odorants at moderately high intensities with musty being most persistent once more intense rancid and sweet odorants were diminished.

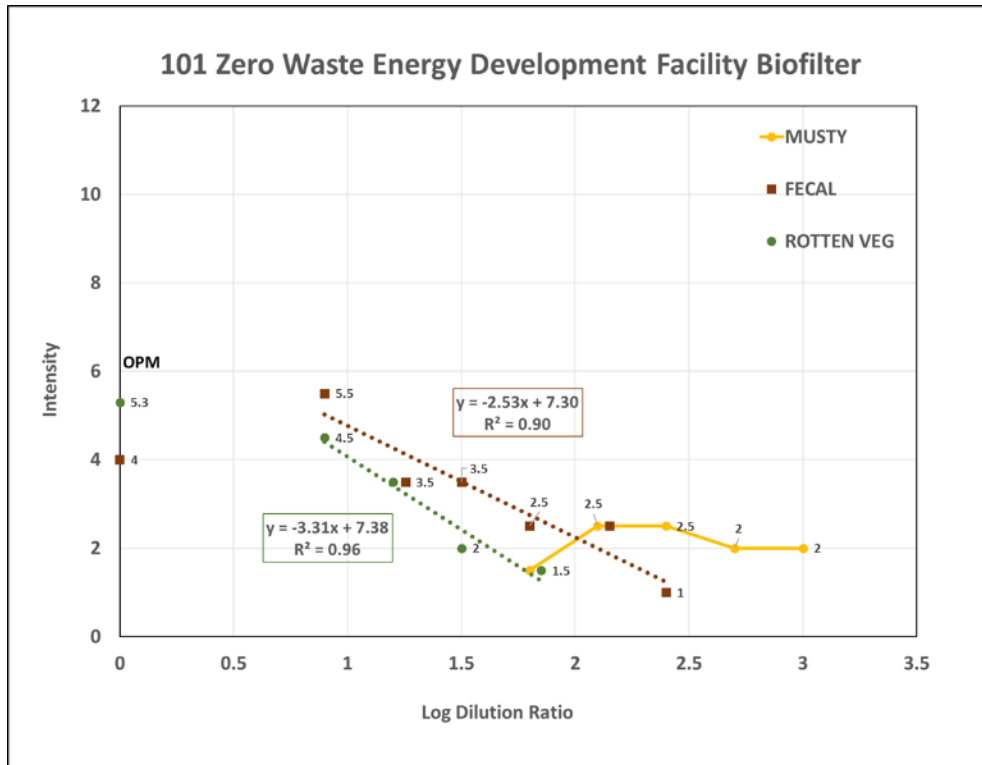

Figure 3-14. ZWED Biofilter OPM Persistency Curves

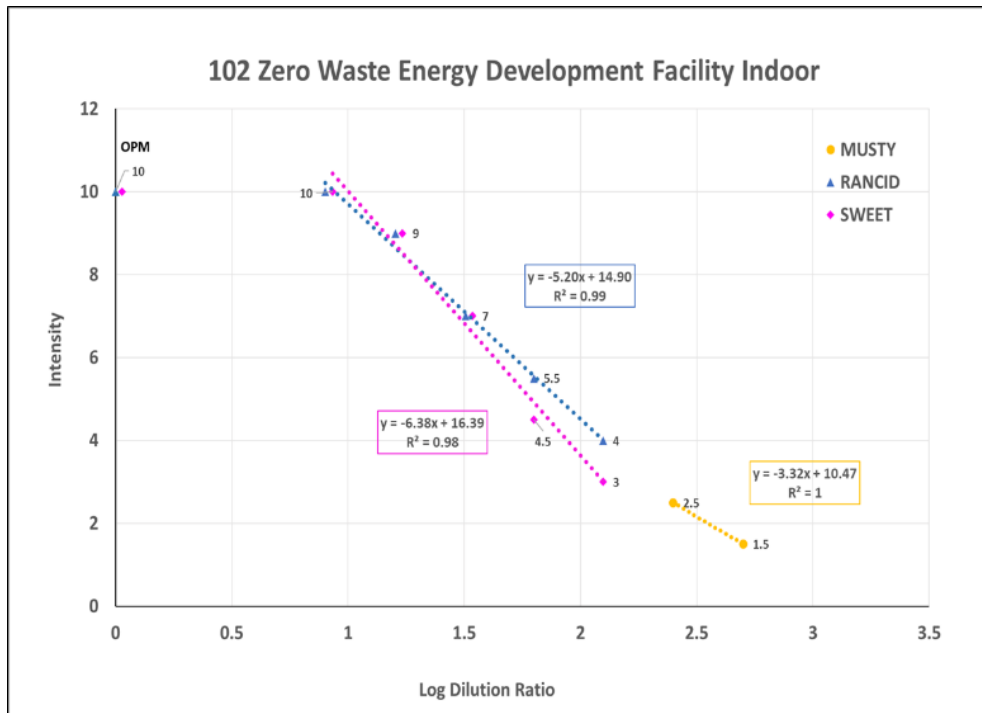

Figure 3-15. ZWED Interior Space OPM Persistency Curves

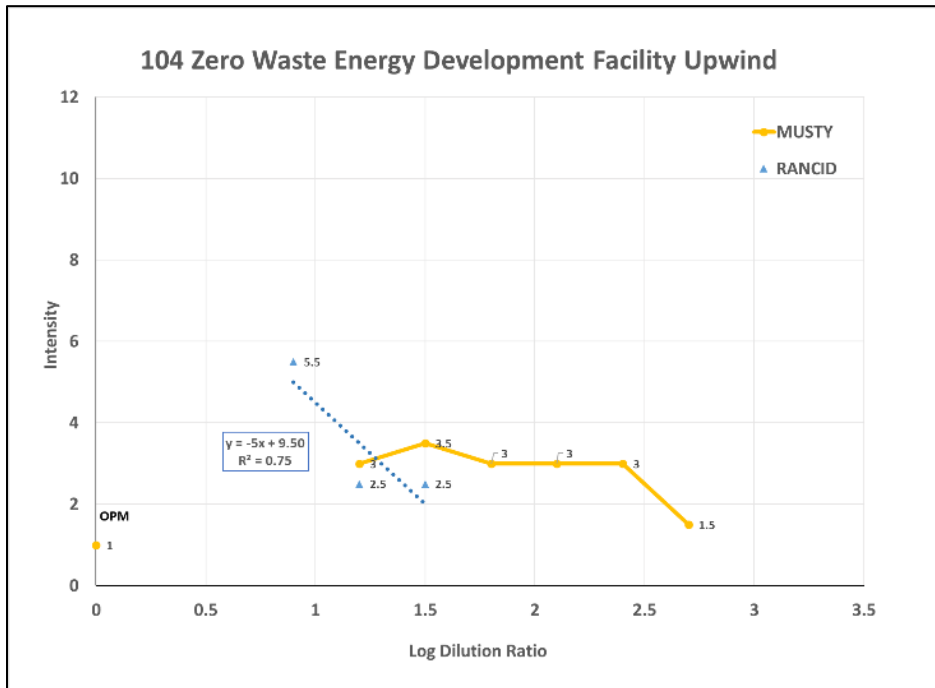

Figure 3-16. ZWED Upwind OPM Persistency Curves

Note: This sampling location is upwind of ZWED, but wind direction at time of sampling was from the northeast. It is therefore likely that the persistent musty odorant and rancid odor was emitted from the lagoons northeast of the facility.

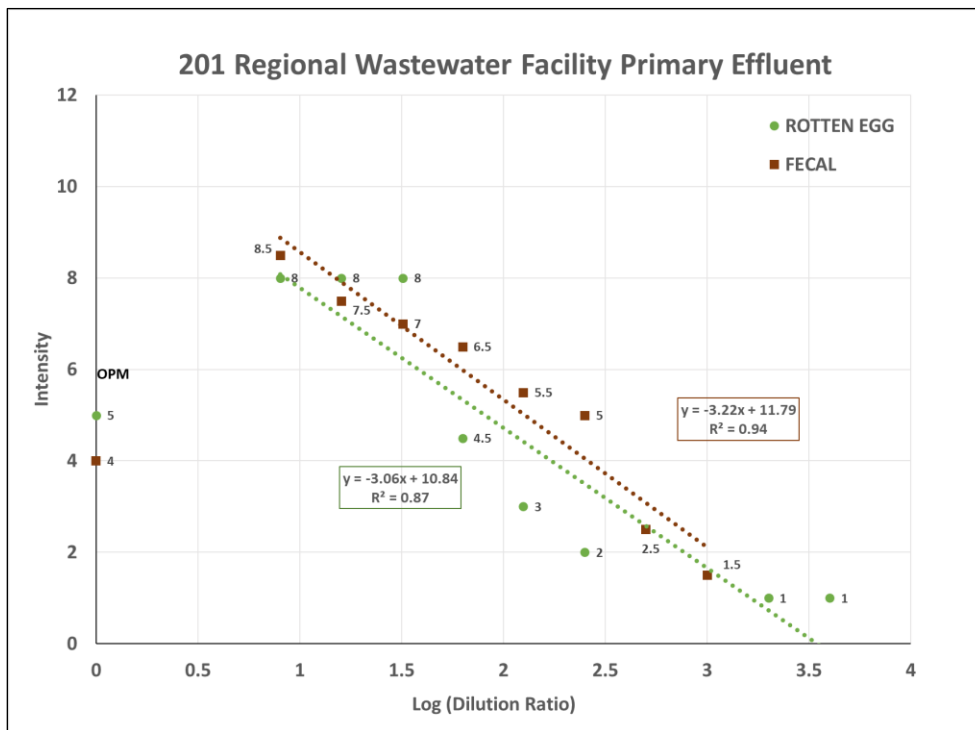

Figure 3-17. RWF Primary Effluent OPM Persistency Curves

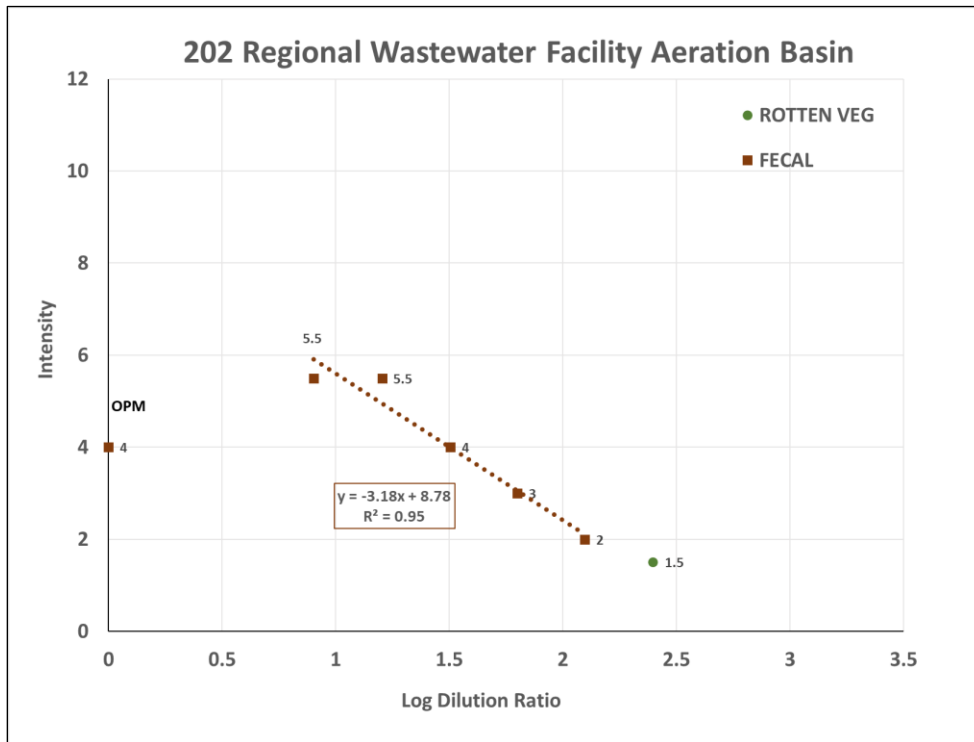

Figure 3-18. RWF Aeration Basin OPM Persistency Curves

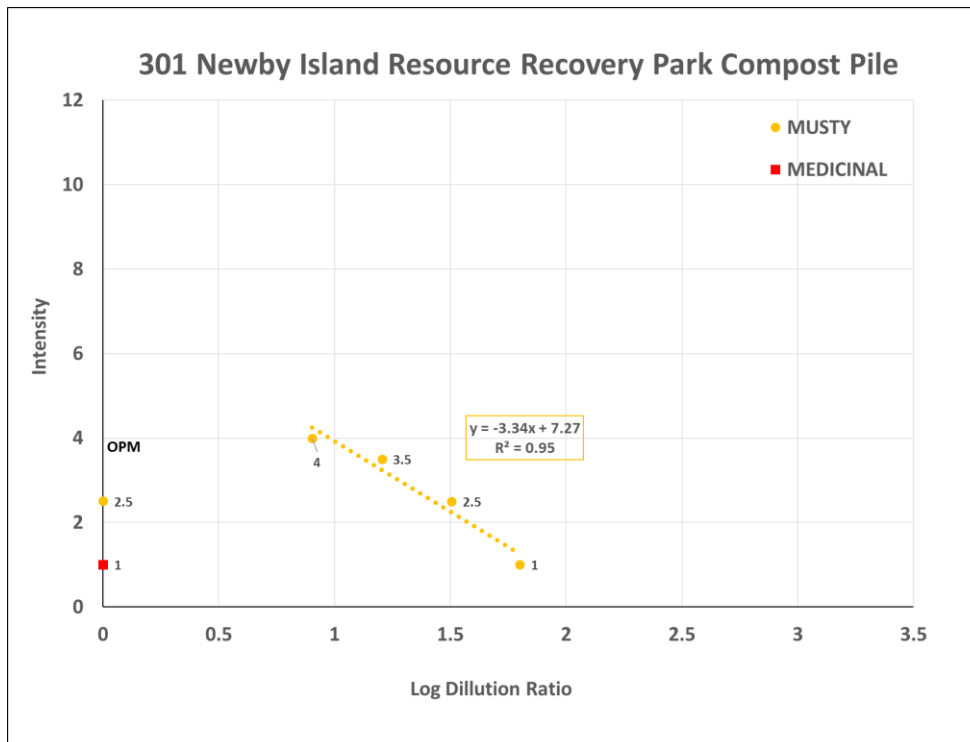

Figure 3-19. NIRRP Compost Pile OPM Persistency Curves

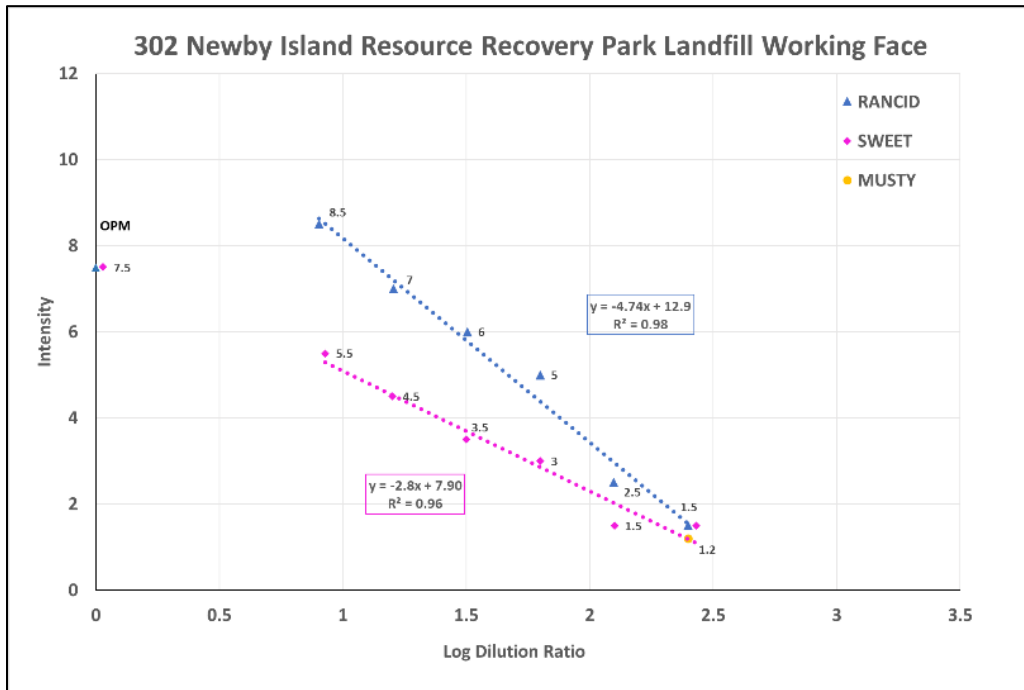

Figure 3-20. NIRRP Landfill Working Face OPM Persistency Curves

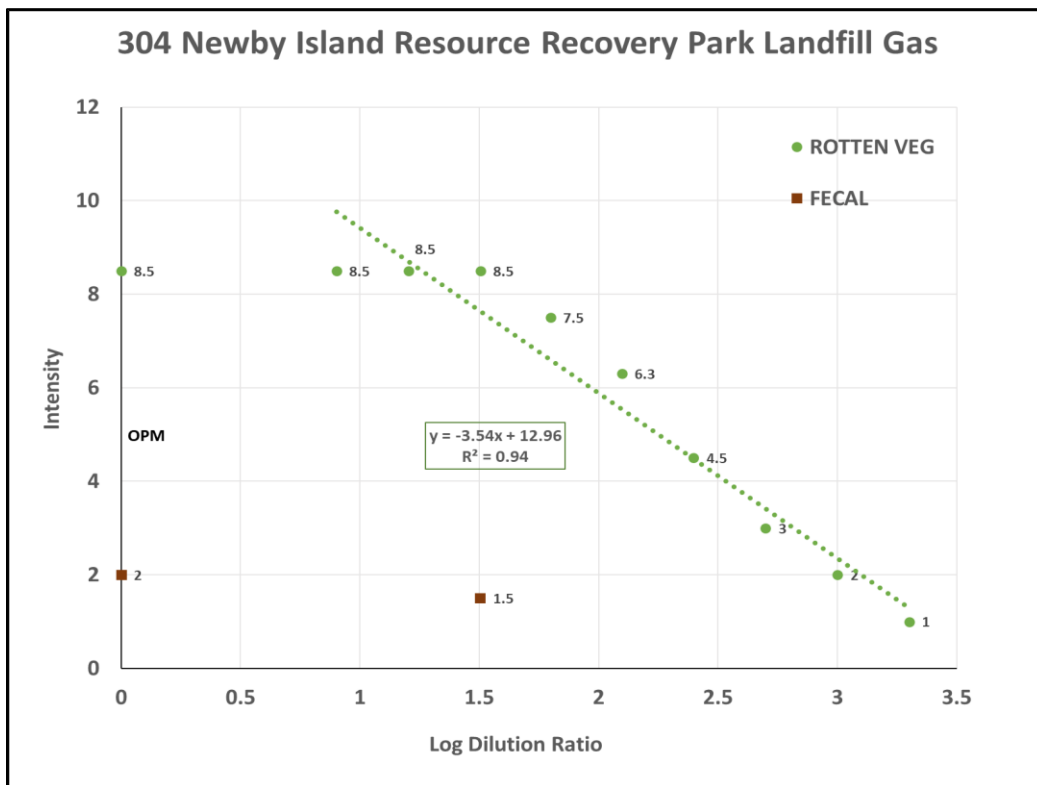

Figure 3-21. NIRRP Landfill Gas OPM Persistency Curves

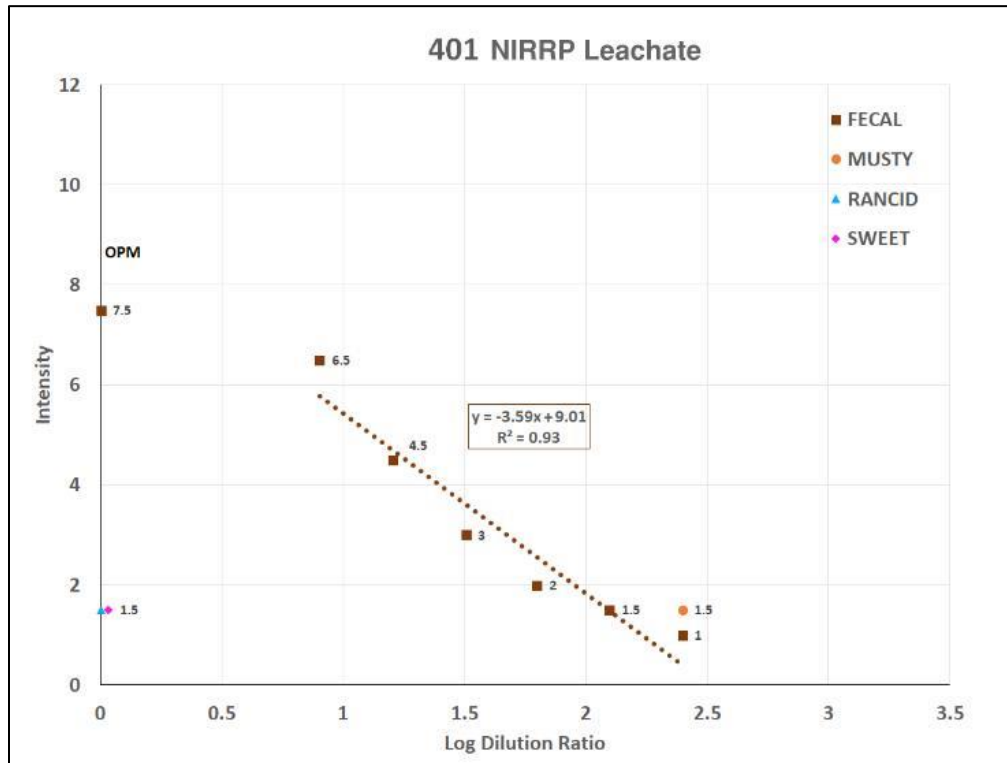

Figure 3-22. NIRRP Landfill Leachate OPM Persistency Curves

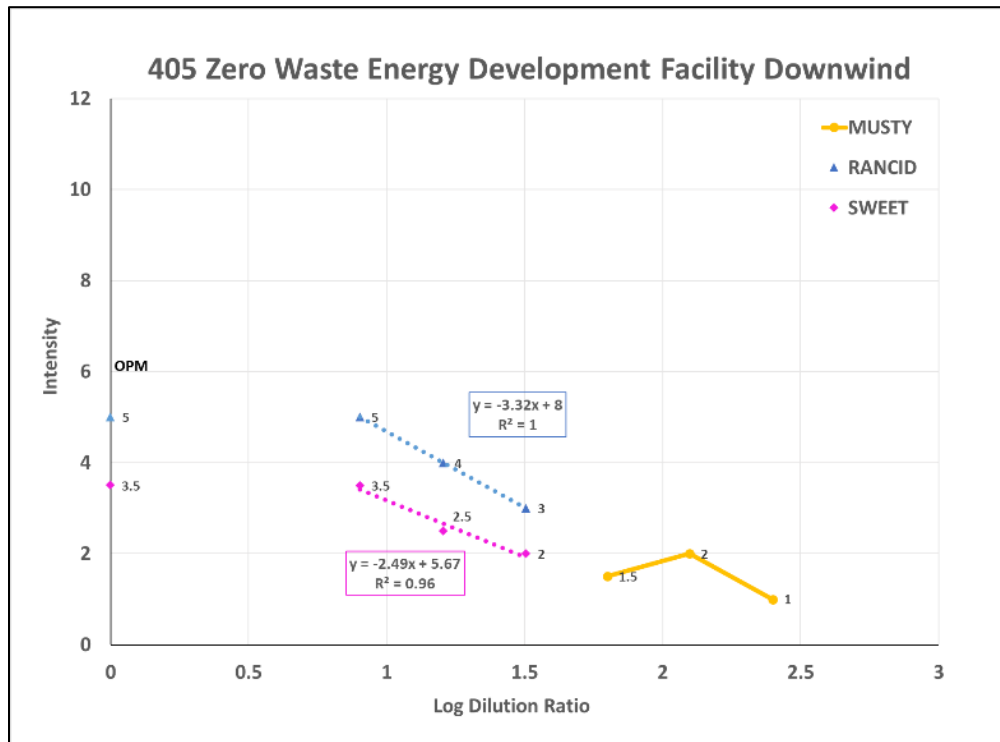

Figure 3-23. ZWED Downwind OPM Persistency Curves

### 3.2.1.4.3 Odor Activity Values

Odor Activity Values (OAVs) quantify odor potency/importance in terms of the ratio of measured concentration of an odorant to its OTC. Figure 3-24 through Figure 3-26 provide a comparison of OAVs for all measured sources at ZWED, RWF, and NIRRP, respectively. An OAV that exceeds 10 is considered to be a possible nuisance odor as it represents an odorant that requires a minimum dilution of 10:1 to reduce the strength of the odorant to below its OTC. Therefore, the OAV action level is equal to 10 and is shown as dashed red line below. Note the following:

- Sulfur-based compounds (characterized as rotten eggs, rotting vegetables) are shown as blue.
- Aldehydes (characterized as sweet) are shown as red.
- Carboxylic acids (characterized as rancid) are shown as yellow.
- VOCs (characterization varies) are shown as green.
- Amines (characterized as fishy) are shown as brown.

Key findings from these results include:

- The ZWED interior space source exhibited a combination of rancid, sweet, and sulfur compounds, many of which exceeded the OAV action level.
- The ZWED biofilter exhibited mostly sulfur compounds, several of which exceeded the OAV action level.
- For the RWF sources, only sulfur compounds exceeded the OAV action level.
- The NIRRP working face source exhibited a combination of rancid, sweet, and sulfur compounds, many of which exceeded the OAV action level.
- The NIRRP landfill gas source exhibited the highest OAVs of any source, including sulfur, rancid, sweet, and VOC compounds. This was to be expected based on the potency of the source.

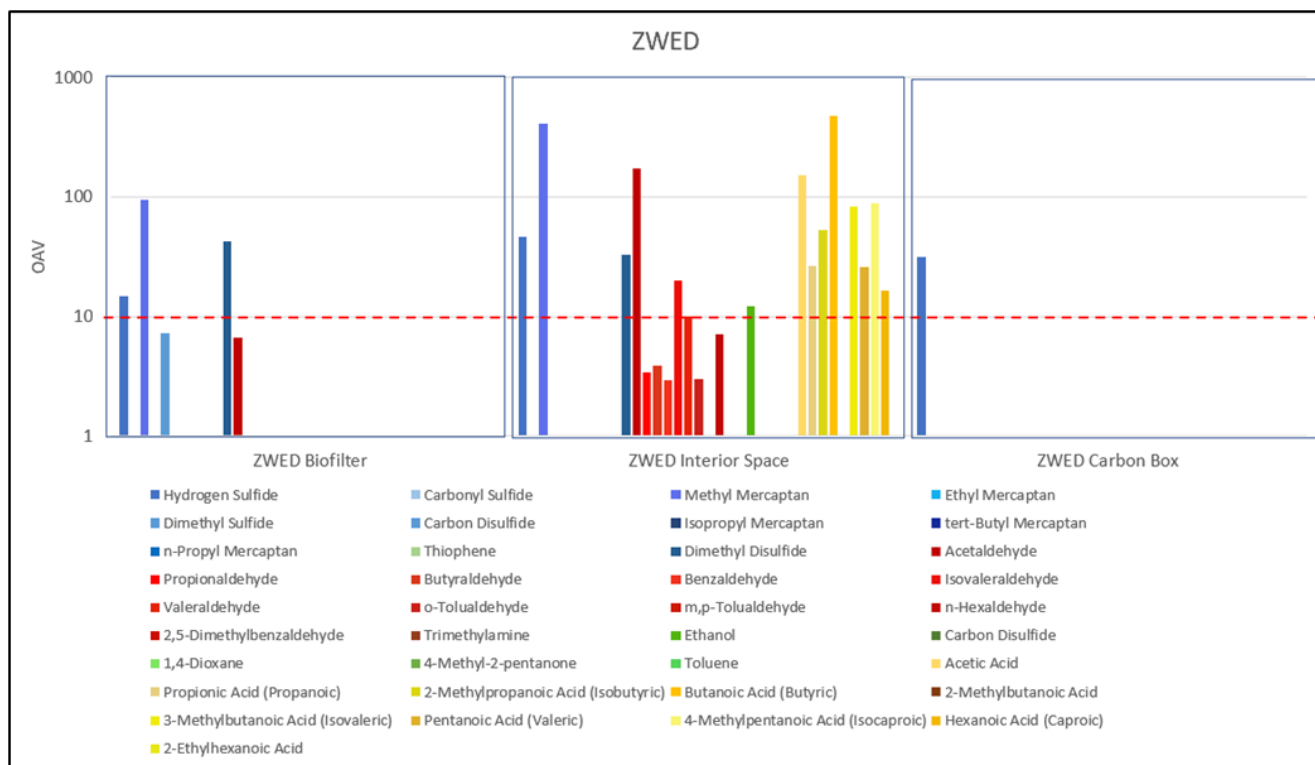

Figure 3-24. Sampling Event 1 OAV Comparison for ZWED

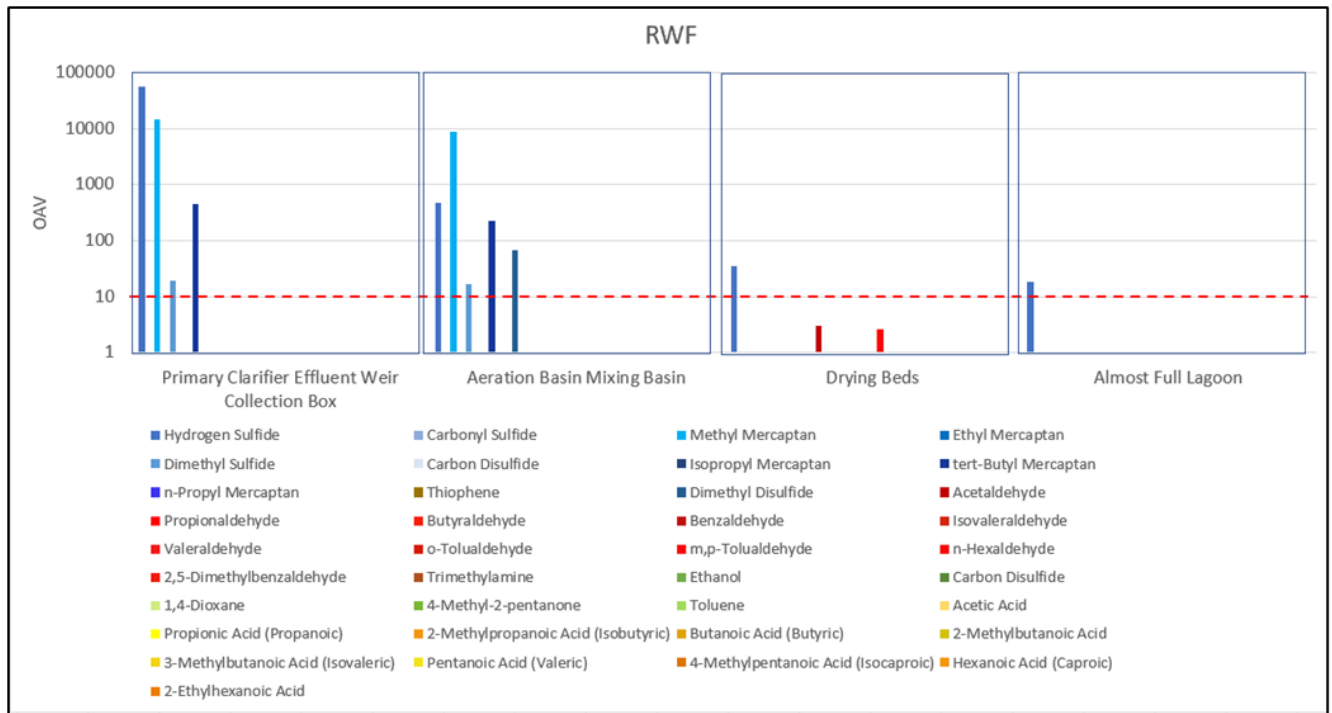

Figure 3-25. Sampling Event 1 OAV Comparison for RWF

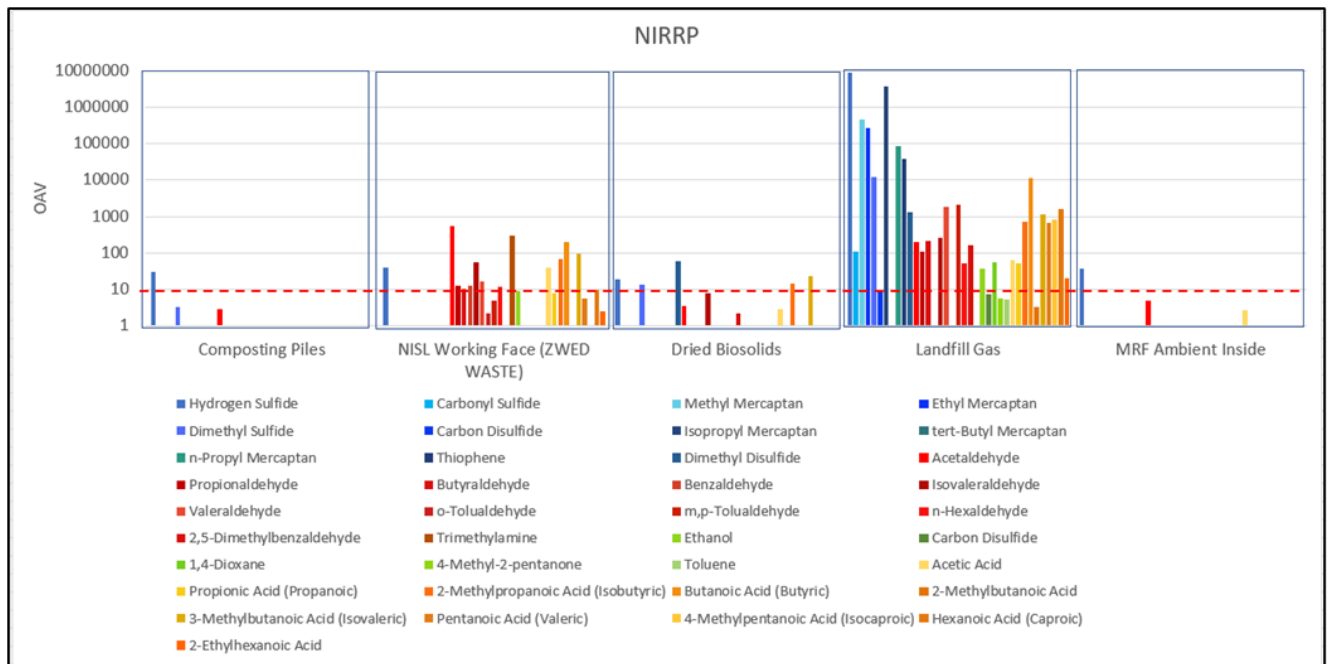

Figure 3-26. Sampling Event 1 OAV Comparison for NIRRP

### 3.2.1.5 Field Measurement and Survey Results

Continuous hydrogen sulfide monitoring and field odor assessment results are presented in this section.



### 3.2.1.5.1 Continuous H<sub>2</sub>S Monitoring

Continuous H<sub>2</sub>S monitoring devices (Acrulog units) were deployed at the interior space at ZWED, the activated carbon filter on the roof serving the membrane digester gas holder annular space at ZWED, and the primary clarifier effluent launder/box at RWF, respectively, from October 19, 2020, to November 5 and 6, 2020.

Figure 3-27 through Figure 3-29 illustrate the H<sub>2</sub>S trending at these locations. Measurements were recorded every 3 minutes. With reference to Figure 3-29, note that the H<sub>2</sub>S monitoring devices likely became submerged late on October 20. Therefore, the first 36 hours of data are considered viable.

The key findings are summarized as follows:

- Moderate sporadic H<sub>2</sub>S spikes were observed at the ZWED interior space source. These likely coincided with specific odorous loads entering the space and/or being agitated leading to outgassing and short-term spikes before the material is processed and moved into the digester units.
- Minor H<sub>2</sub>S breakthrough was observed at the ZWED digester roof activated carbon filter source. It appears that the breakthrough events were infrequent and likely coincided with the digester gas storage unit annular space “breathing” through the activated carbon filter. The activated carbon media was likely nearly spent and was in need of replacement.
- High H<sub>2</sub>S levels were observed at the RWF primary effluent launder source, with concentrations recorded as high as 130 ppmv. No real diurnal trends could be detected.

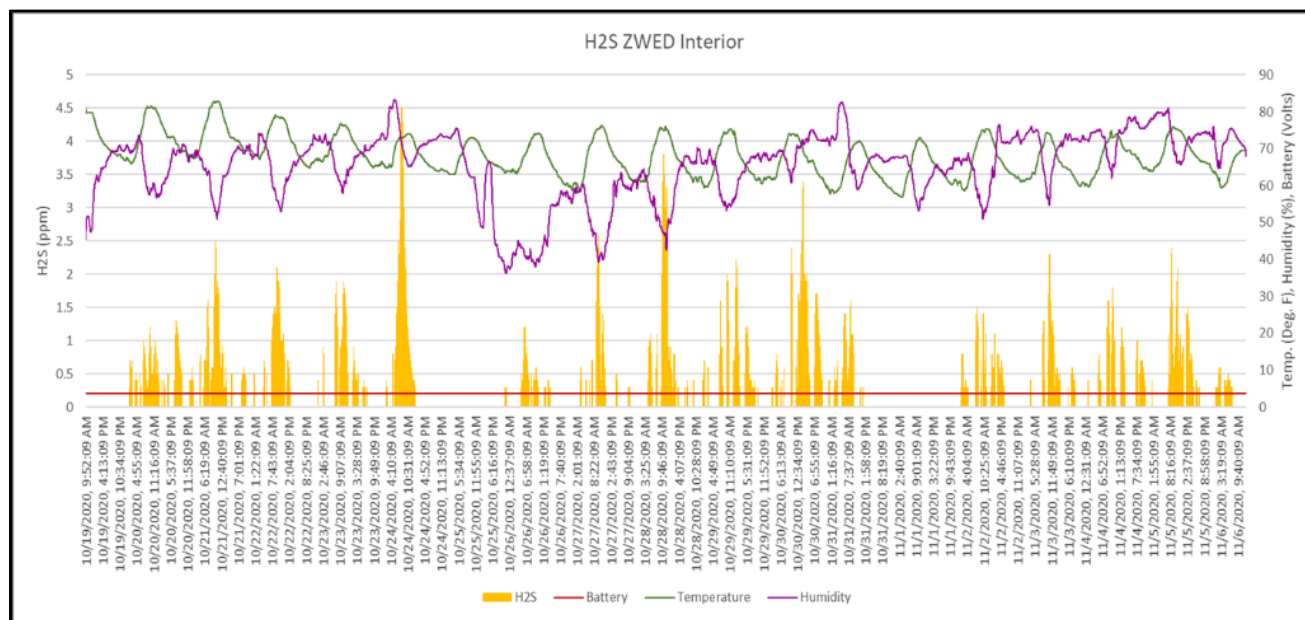

Figure 3-27. Sampling Event 1 H<sub>2</sub>S Continuous Monitoring Results for ZWED Interior Space

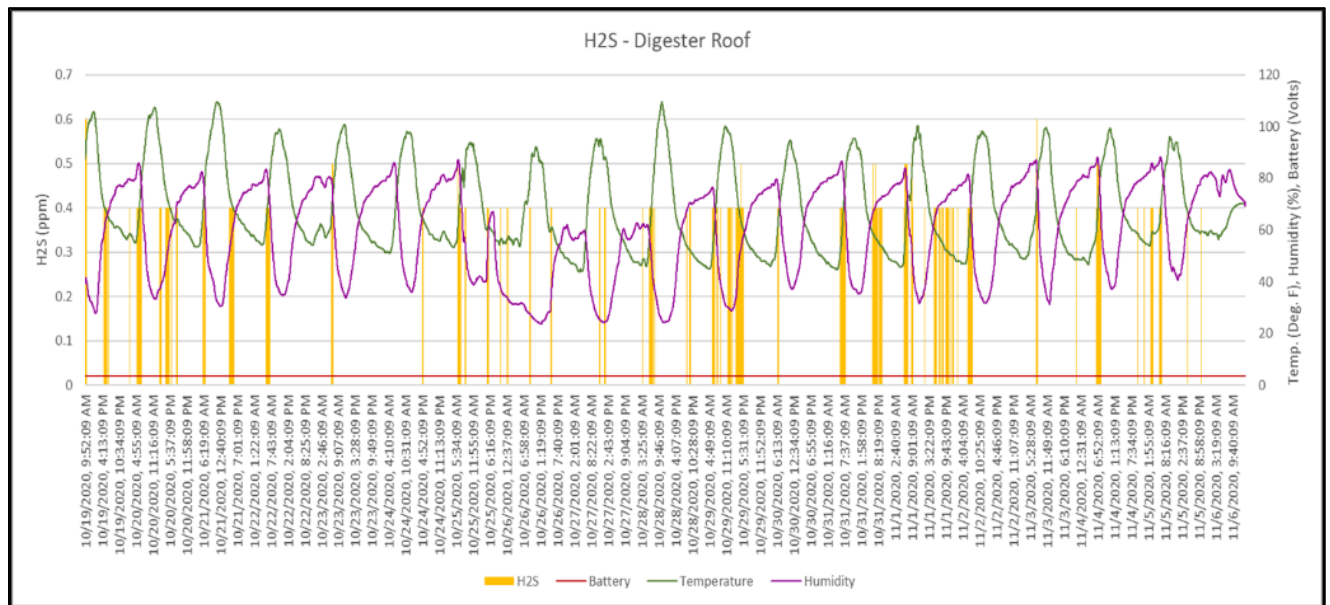

Figure 3-28. Sampling Event 1 H<sub>2</sub>S Continuous Monitoring Results for ZWED Activated Carbon Filter

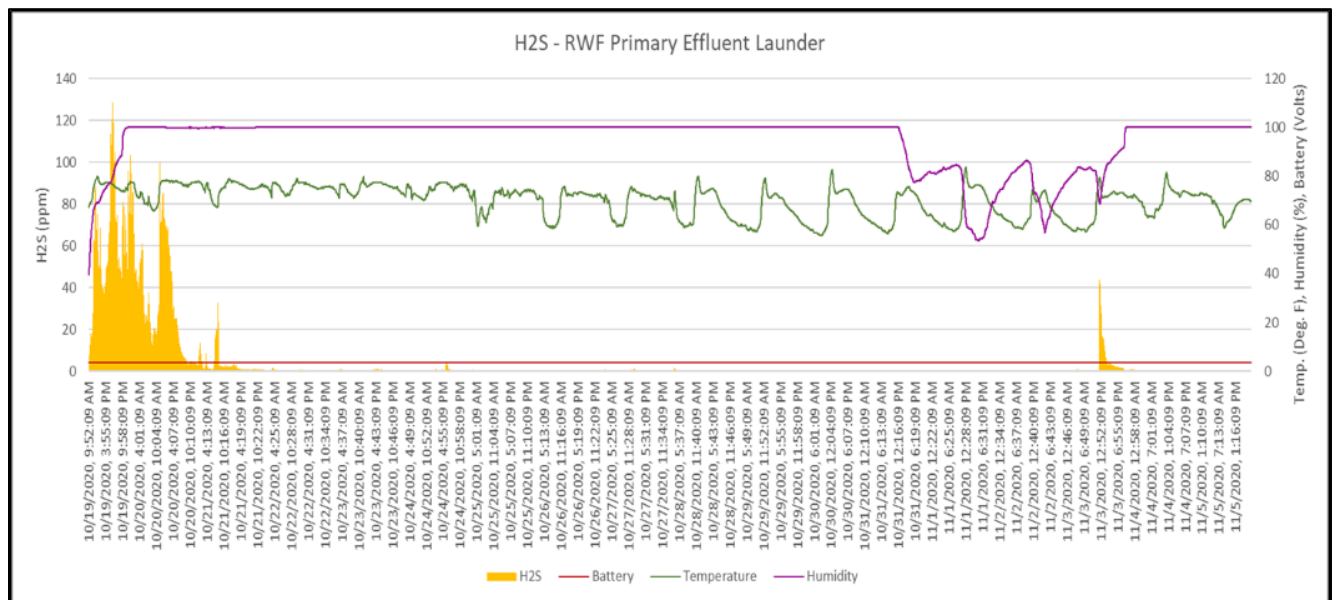

Figure 3-29. Sampling Event 1 H<sub>2</sub>S Continuous Monitoring Results for RWF Primary Clarifier Effluent Launder/Box

### 3.2.1.5.2 Field Odor Assessment Results

The field odor assessment was performed using the Scentroid MS100 field olfactometer. Measurements were taken in the neighboring communities as well as up- and downwind of ZWED, NIRRP, and RWF at the locations shown on Figure 3-30. The same assessment locations were used for all sampling events.

The results of the field odor assessment performed during this sampling event are presented in Appendix B - Section B.1. In the afternoon of the first three days of the sampling event, the Field Team joined the Facility Team to measure some of the sources at and around the various facilities. The results of these measurements are also included in the summary tables in Appendix B - Section B.1.

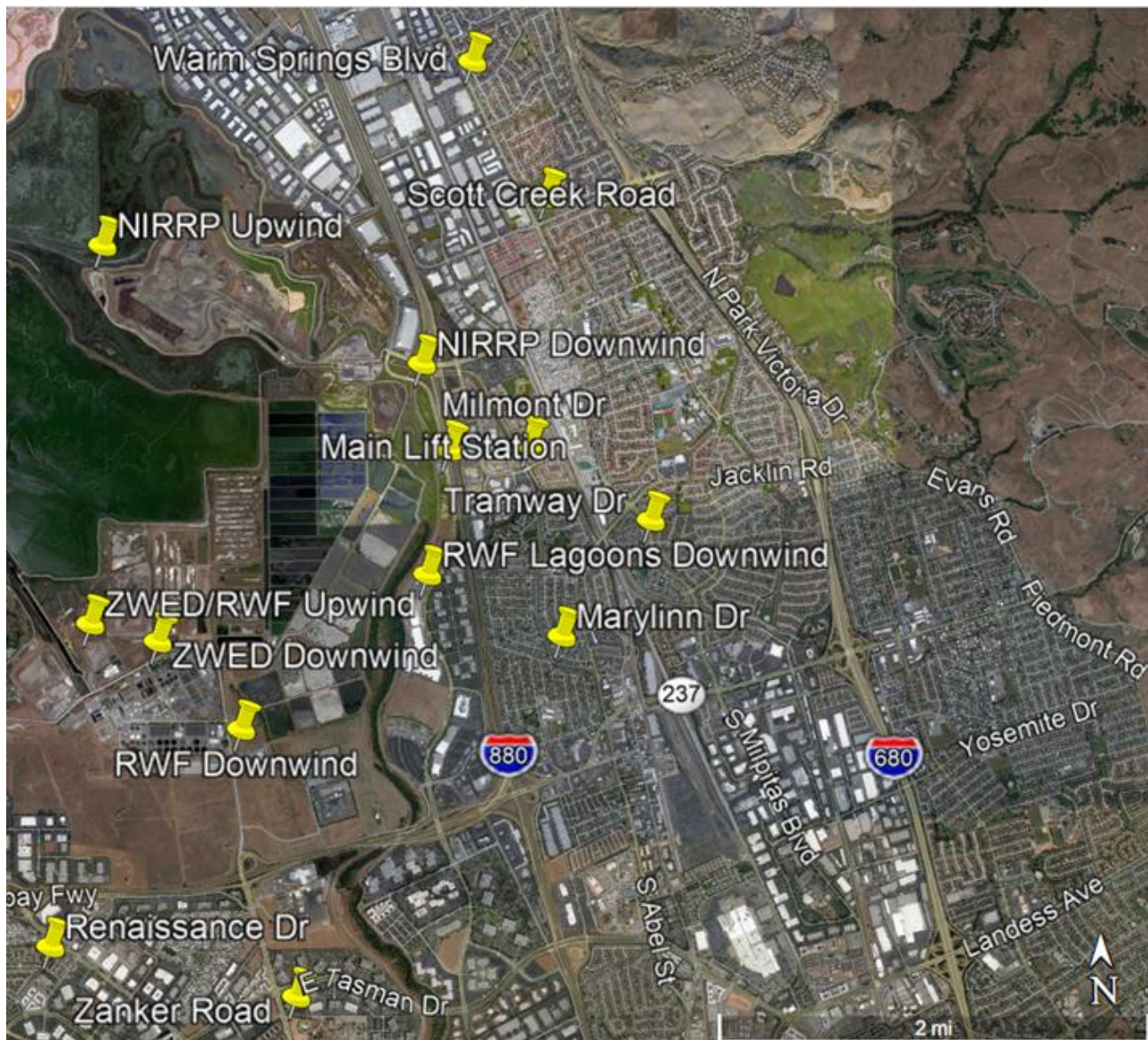

Figure 3-30. Field Odor Assessment Locations

The field odor assessment performed in the neighboring communities as well as nearby the main odor emitting facilities showed that:

- Odors were observed frequently in the community mainly at Scott Creek Road, Marilynn Drive, and Milmont Drive, but also at Tramway Drive, Zanker Road, Renaissance Road, and Warm Spring Boulevard.
- Strong odors were observed near the three main odor emitting facilities (ZWED, NIRRP, RWF) and led to the identification of the following key odor sources:
  - ZWED: interior space, biofilters and potentially also the activated carbon filter
  - RWF: bioreactors, primaries and potentially also the drying beds, the main lift station, and the lagoons
  - NIRRP: landfill working face, landfill gas leaks and potentially also the composting area

### 3.2.2 Sampling Event 2 – Winter 2020/21

#### 3.2.2.1 Description

The sampling event took place on March 2, 2021. The sampling schedule was as follows:

- Morning: Samples were collected at ZWED interior, RWF, and upwind
- Afternoon: Samples were collected at ZWED Biofilter, NIRRP, and Downwind

Weather:

- Morning light winds out of the southeast
- Afternoon stronger winds out of the northwest
- Temperature: High: 65°F and Average Daily: 54°F

The sampling matrix for this event is included as Table 3-20.

#### 3.2.2.2 Observations

Sampling was completed as scheduled at ZWED and RWF on Monday morning. The following observations were made:

- Odors in the ZWED Interior Space were potent, with odors similar to those observed during the Fall 2020 sampling event.
- The ZWED Biofilters and downwind samples were less odorous than was observed during the Fall 2020 sampling event.
- The RWF Primary Effluent Weir Box had more wastewater turbulence (due to higher wastewater flows) and higher concentrations of H<sub>2</sub>S than during the Fall 2020 sampling event.
- The same RWF bioreactor that switched between anoxic and aerobic timed cycles and was sampled during the Fall 2020 sampling event was sampled during this event. When the blowers were switched on, odors noticeably increased and smelled 10 times stronger.

Sampling was completed as scheduled at NIRRP on Monday afternoon. Some observations are listed:

- Landfill working face odors were less intense than those observed during the Fall 2020 sampling event. This could be because the Fall 2020 sampling activities took place in a bowl-shaped area within the landfill that allowed heat and odor build up. By the time of the Winter sampling event, the area had been filled with waste and the sampling location effectively situated at the top of a hill as a result. Jacobs sampled right after ZWED waste was delivered prior to waste being compressed and then buried, just as was done during the Fall 2020 sampling event.

**Table 3-20. Sampling Event 2 Sampling Matrix**

Sampling Set	Source ID	Source	Number of Samples per event	Odor Constituent, Sample Collection, and Sample Analysis Method		
				Olfactometry Laboratory (OU/m <sup>3</sup> )	Montrose <sup>a</sup>	H <sub>2</sub> S
				10-L Tedlar Bag	10-L Teflon Bag	In-field
				ASTM E679-04 Standard of Practice with a presentation rate of 20 liters per minute (per EN 13725)		Jerome Meter <sup>b</sup>
RWF	1	East Primaries	1	X	X	X
	2	Bioreactors	1	X	X	X
ZWED	3	ZWED Interior Space	1	X	X	X
	4	Biofilter 1	1	X	X	X
NISL	5	Landfill Working Face	1	X	X	X
Upwind	6	Upwind of Facilities <sup>c</sup>	1	X	X	X
Downwind	7	Downwind of Facilities (near) <sup>de</sup>	1	X	X	X

<sup>a</sup> Samples to be sent to Montrose to perform an initial scan to identify the wide range of individual compounds and specific markers of these odor sources.

<sup>b</sup> Field H<sub>2</sub>S measured from bag and recorded on chain of custody sheets.

<sup>c</sup> Selected location to be decided day of sampling event dependent upon wind conditions.

<sup>d</sup> Downwind preliminary location to be Milmont Drive. Final location to be decided day of sampling event dependent upon wind conditions.

<sup>e</sup> Samples collected if time permits.

EN = European norm

OU/m<sup>3</sup> = odor units per cubic meter

### 3.2.2.3 Results

Laboratory analytical results are presented below as tables and figures. The laboratory reports are included in Appendix B.

#### 3.2.2.3.1 General Odor Analysis (ASTM E769-04) Results

Odor panel analysis results are summarized in Table 3-21 for ZWED, RWF, and NIRRP. The RWF east primaries and the Bioreactors exhibited the highest general odor concentrations. Furthermore, the most offensive sources (most negative HT) were the ZWED interior space and the working face of the landfill.

**Table 3-21. Sampling Event 2 General Odor Laboratory Results**

Sample Description	D/T	RT	I	HT	DR	Comments
ZWED Int. Space	1,400	890	5.6	-4.4	---	
Upwind (Light Wind SSE)	40	35	2.7	-1.4	---	
East Primaries	140,000	100,000	---	---	---	Field sample diluted 10:1 for threshold evaluation. Sample not observed for Intensity or Characterization.
Bioreactors	96,000	65,000	---	---	---	Field sample diluted 10:1 for threshold evaluation. Sample not observed for Intensity or Characterization.
Working Face of Landfill	650	390	4.8	-5.1	---	
ZWED Biofilters	280	180	5.5	-1.0	---	
DW (Downwind)	65	50	2.8	-2.0	---	

Notes: DR = dilution ratio; I = intensity; RT = recognition to threshold

Table 3-22 summarizes overall “fingerprint” odorants pertaining to specific sources.

**Table 3-22. Sampling Event 2 General Odor Laboratory Results**

Location	Key Fingerprint Odorants
RWF: Primaries Bioreactors	Sulfur Compounds <sup>a</sup> Sulfur Compounds (MM, EM, DMS, DMDS). Earthy (pyrazines)
ZWED: Interior  Biofilter	Carboxylic Acids (propanoic acid) Aldehydes (isobutyraldehyde, benzaldehyde) VOC (2-butanone [low]) Low Levels - Carboxylic Acids (acetic acid) Low Levels – Pyrazines (earthy)
NIRRP: Working Face	Carboxylic Acids (acetic acid, propanoic acid) Aldehydes (isobutyraldehyde, benzaldehyde)
Offsite Downwind	Low Levels - Carboxylic Acids (acetic acid)

<sup>a</sup> No sulfur compounds detected by Montrose

Figures 3-31 through 3-35 depict the average sensation of the odor descriptors (on a scale 1 to 10). These figures are similar to odor wheels. No figures have been provided for RWF East Primaries and Bioreactors. This is because those samples required post-dilution in the lab, precluding the ability to develop the descriptor graphs. General findings are as follows:

- The ZWED interior exhibited primarily decay (i.e., sulfur/fecal), which was different than Sampling Event 1 in which rancid was observed.
- The ZWED biofilter exhibited primarily earthy, which was different than Sampling Event 1 in which rancid and decay were observed. This could be due to better performance of the biofilter, or lower concentrations of foul air being treated during Sampling Event 2.
- NIRRP working face exhibited strong odors in primarily the decay category, differing from Sampling Event 1 in which several nuisance categories including decay and dairy (i.e., rancid) were observed.
- The downwind sample exhibited low odors.

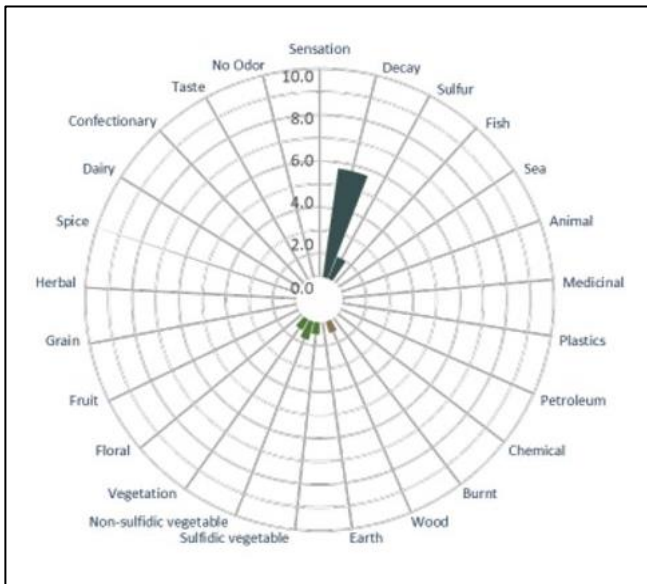

Figure 3-31. Odor Descriptors for ZWED Interior

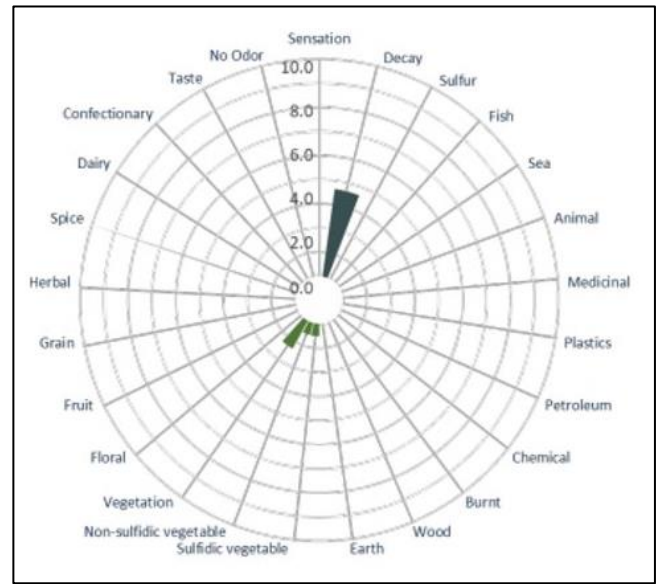

Figure 3-32. Odor Descriptors for NIRRP Working Face

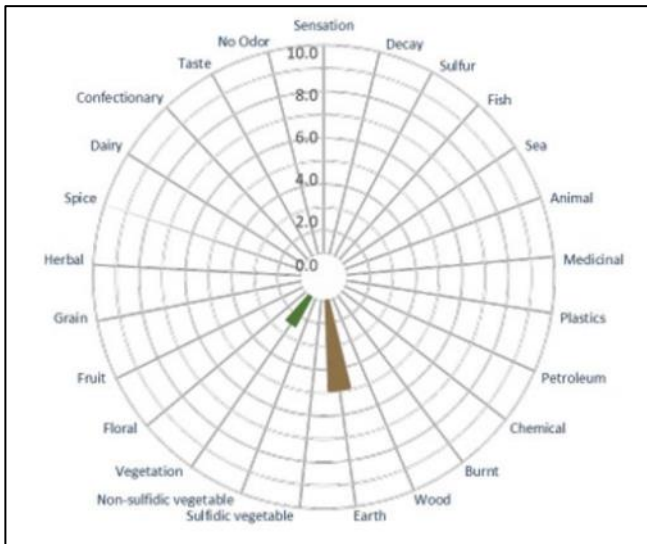

Figure 3-33. Odor Descriptors for ZWED Biofilter

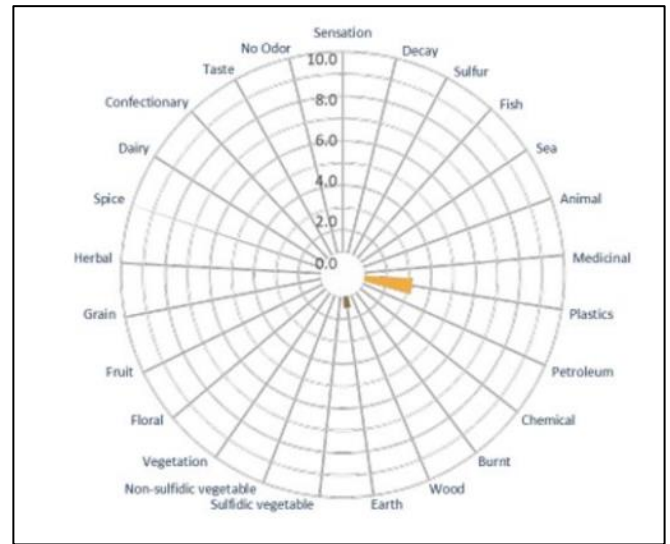

Figure 3-34. Odor Descriptors for Downwind Sample

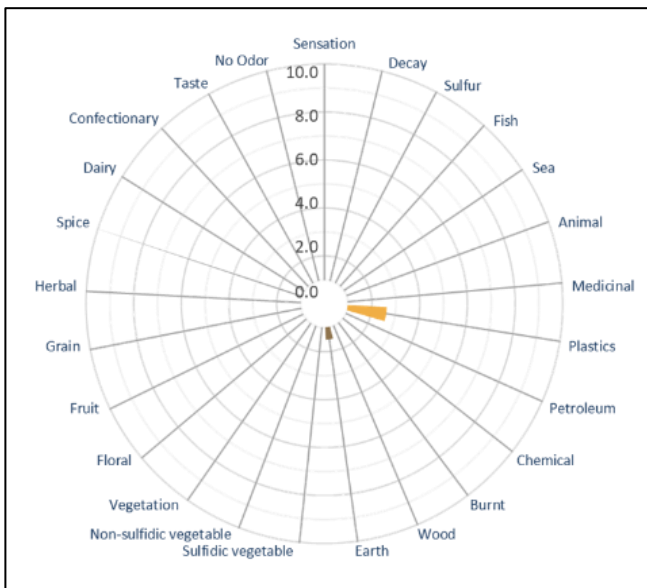

Figure 3-35. Odor Descriptors for Upwind

**3.2.2.3.2 Odor Profile Method Results**

OPM analysis was not performed for Sampling Event 2.



### 3.2.3 Sampling Event 3 – Spring 2021

#### 3.2.3.1 Description

The sampling event took place during the week of May 17 to 20, 2021. Jacobs sampling activities for this event were coordinated with Montrose’s sampling activities to allow for correlation and validation of results for both studies. The sampling schedule was as follows:

- Monday: Samples were collected at the ZWED facility
- Tuesday: Samples were collected at RWF
- Wednesday: Samples were collected at NIRRP
- Thursday: Samples were collected from facility downwind locations

Weather:

- Monday/Tuesday
  - Morning winds were out of the south-southeast
  - Afternoon winds were out of the northwest
- Wednesday/Thursday: Winds were out of the northwest
- Temperature: High: 73°F and Average Daily: 61°F

The sampling matrix for this event is shown in Table 3-23. As indicated, sources and specific sampling analyses were tailored based on previous sampling event results.

Table 3-23. Sampling Event 3 Matrix

Sampling Set	Source ID	Source	Number of Samples per event	Odor Constituent, Sample Collection and Sample Analysis Method											
				Odor Profile Method (OPM)	Reduced Sulfur	Olfactometry Laboratory (OU/m <sup>3</sup> )	Aldehyde	Amines	VOCs	Carboxylic Acid	Ammonia	Spot H <sub>2</sub> S	Montrose	Continuous H <sub>2</sub> S	Olfactometer Field (D/T)
				Teflon Bag	Tedlar Bag <sup>c</sup>	Teflon Bag	Sorption Tubes	Sorption Tubes	Sorption Tubes	Sorption Tubes	In-field	In-field	Teflon Bag	In-field	In-field
				Modified Standard Method 2170: Flavor Profile Analysis Method (applied to air)	ASTM D5504 Method by Modified GC/SCD with sulfur chemiluminescence	ASTM E679-04 Standard of Practice with a presentation rate of 20 liters per minute (per EN 13725)	TO -11A (EPA 1999)	ALS (sorbent tube) Method 101 (their unique standard method)	TO -17 (EPA 1999)	ALS (sorbent tube) Method 102 (their unique standard method)	Draeger tubes	Jerome Meter	10 liter	OdaLog	Scentroid SM-100
RWF	1	East Primaries	1	X <sup>a,d</sup>	X	X	See Note <sup>g</sup>	See Note <sup>g</sup>	See Note <sup>g</sup>	See Note <sup>g</sup>	See Note <sup>g</sup>	X	X <sup>b</sup>	X	X
	2	Bioreactors (mixing zone)	1	X <sup>a,d</sup>	X	X	X	See Note <sup>g</sup>	X	X	See Note <sup>g</sup>	X	X <sup>b</sup>	X <sup>e</sup>	X
	3	Bioreactors (aerobic zone)	1	X <sup>a,d</sup>	X	X	X	See Note <sup>g</sup>	X	X	See Note <sup>g</sup>	X	X <sup>b</sup>	See Note <sup>g</sup>	X
	4	Lagoons	1	X <sup>a,d</sup>	See Note <sup>g</sup>	X	See Note <sup>g</sup>	See Note <sup>g</sup>	See Note <sup>g</sup>	See Note <sup>g</sup>	X	See Note <sup>g</sup>	X <sup>b</sup>	See Note <sup>g</sup>	X
	5	RWF Upwind	1	X <sup>a,d</sup>	See Note <sup>g</sup>	See Note <sup>g</sup>	See Note <sup>g</sup>	See Note <sup>g</sup>	See Note <sup>g</sup>	See Note <sup>g</sup>	See Note <sup>g</sup>	See Note <sup>g</sup>	See Note <sup>g</sup>	See Note <sup>g</sup>	X
	6	RWF Downwind	multiple	X <sup>a,d</sup>	See Note <sup>g</sup>	See Note <sup>g</sup>	See Note <sup>g</sup>	See Note <sup>g</sup>	See Note <sup>g</sup>	See Note <sup>g</sup>	See Note <sup>g</sup>	See Note <sup>g</sup>	See Note <sup>g</sup>	See Note <sup>g</sup>	X
ZWED	7	ZWED Interior Space	1	X <sup>a,d</sup>	X	X	X	See Note <sup>g</sup>	X	X	X	X	X <sup>b</sup>	X	X
	8	Biofilter 1	1	X <sup>a,d</sup>	X	X	X	See Note <sup>g</sup>	X	X	See Note <sup>g</sup>	X	X <sup>b</sup>	X	X
	9	ZWED Upwind	1	X <sup>a,d</sup>	See Note <sup>g</sup>	See Note <sup>g</sup>	See Note <sup>g</sup>	See Note <sup>g</sup>	See Note <sup>g</sup>	See Note <sup>g</sup>	See Note <sup>g</sup>	See Note <sup>g</sup>	See Note <sup>g</sup>	See Note <sup>g</sup>	X
	10	ZWED Downwind	multiple	X <sup>a,d</sup>	See Note <sup>g</sup>	See Note <sup>g</sup>	See Note <sup>g</sup>	See Note <sup>g</sup>	See Note <sup>g</sup>	See Note <sup>g</sup>	See Note <sup>g</sup>	See Note <sup>g</sup>	See Note <sup>g</sup>	See Note <sup>g</sup>	X
NIRRP	11	Landfill Working Face (no ZWED "overs")	1	X <sup>a,d</sup>	See Note <sup>g</sup>	X	X	See Note <sup>g</sup>	X	X	See Note <sup>g</sup>	X	X <sup>b</sup>	See Note <sup>g</sup>	X
	12	Compost Piles and/or Green Waste Facility and/or Curing Piles	1	X <sup>a,d</sup>	See Note <sup>g</sup>	X	X	See Note <sup>g</sup>	X	X	See Note <sup>g</sup>	X	X <sup>b</sup>	See Note <sup>g</sup>	X
	13	MRF	1	See Note <sup>g</sup>	See Note <sup>g</sup>	X	See Note <sup>g</sup>	See Note <sup>g</sup>	See Note <sup>g</sup>	See Note <sup>g</sup>	See Note <sup>g</sup>	See Note <sup>g</sup>	See Note <sup>g</sup>	See Note <sup>g</sup>	X
	14	Landfill Gas	1	X <sup>a,d</sup>	X	X	X	See Note <sup>g</sup>	X	X	See Note <sup>g</sup>	X	X <sup>b</sup>	See Note <sup>g</sup>	X
	15	Landfill Upwind	1	X <sup>a,d,f</sup>	See Note <sup>g</sup>	See Note <sup>g</sup>	See Note <sup>g</sup>	See Note <sup>g</sup>	See Note <sup>g</sup>	See Note <sup>g</sup>	See Note <sup>g</sup>	See Note <sup>g</sup>	See Note <sup>g</sup>	See Note <sup>g</sup>	X
	16	Landfill Downwind	multiple	X <sup>a,d</sup>	See Note <sup>g</sup>	See Note <sup>g</sup>	See Note <sup>g</sup>	See Note <sup>g</sup>	See Note <sup>g</sup>	See Note <sup>g</sup>	See Note <sup>g</sup>	See Note <sup>g</sup>	See Note <sup>g</sup>	See Note <sup>g</sup>	X

Notes: This sampling matrix has been updated based on the results of the October and winter Sampling Events. All samples to UCLA will be measured for RH and recorded.

<sup>a</sup> single 10-liter bag (> 70% full = 7.0 liters) delivered to UCLA for persistency curves.

<sup>b</sup> Montrose to perform scan to identify the specific markers of these odor sources. Due to equipment calibration for ambient locations, these scans may be completed after the daily ambient scans are completed.

<sup>c</sup> It is noted that BAAQMD does not allow the use of Tedlar bags for TRS analysis. Jacobs will research other options (including Teflon, aluminized mylar bags, coated cannisters; and bag conditioning or passivating) for this sampling event

<sup>d</sup> A single 16-liter bag (> 70% full = 11.5 liters) delivered to UCLA for chemical analysis and OPM only

<sup>e</sup> Utilize Mr. Floatie and obtain up to 4 hours of data

<sup>f</sup> If time permits

<sup>g</sup> Specific analysis/method not performed. Only analyses/methods deemed necessary for the specific source (i.e., matching expected odorant emissions or considered non-redundant to other analyses/methods listed) are to be performed. Analysis selection based on past studies, previous sampling event results, best engineering judgment, project budget restraints, or based on the particular source categorized as either critical or non-critical. For example, RWF Downwind is expected to exhibit odor concentrations generally below reporting limits and therefore preclude the need for comprehensive sulfur analysis (i.e., ASTM D5504).

### 3.2.3.2 Observations

Sampling and surveying efforts were completed as scheduled during the week of May 17, 2021. Some observations from this sampling event are listed:

- The Don Edwards San Francisco Bay National Wildlife Refuge area was not part of the original sampling plan. However, because Montrose reported detection of strong plume odors from the Don Edwards San Francisco Bay National Wildlife Refuge area on Wednesday (May 19), Jacobs collected an additional downwind sample at this location the following day and installed an Acrulog for one week to capture any odor anomalies. Several “hits” were observed in the data obtained from the Acrulog unit deployed. It is likely that high sulfates are being converted
- NIRRP 10-L samples sent to St. Croix for odor panel analysis were delayed in transit due to FedEx issues. Therefore, these samples were analyzed after the 24-hour hold time.
- During laboratory analyses, ALS was unable to complete analyses for the carboxylic acid method due to equipment malfunction. The sorption tubes were sent to their Utah laboratory and a modified method was performed.
- Acrulog units were deployed at several locations during Sample Event 3:
  - No hits were found in the Bioreactors, using the inverted bucket on the liquid surface (“Mr. Floatie”). Jacobs noted that it was likely that odor emissions during this time were characterized as a diurnal “low” because the upstream East Primaries H<sub>2</sub>S was low at this time.
  - East Primaries had high odor emissions in the afternoon and low in the morning.
  - ZWED Biofilter and Interior Space showed similar trends as observed from the previous sampling events.
- NIRRP compost pile sampled was the 24-hour ground uncovered green waste used as feedstock for the covered compost bunkers. Composted green waste consists of greater than 90 percent residential green waste and less than 10 percent commercial green waste. Odors were observed to smell similar to chewing tobacco.
- For safety reasons, NISL working face sample was collected from a subsidiary working face in which residential trash waste was sampled in lieu of the ZWED residuals sampled during Sampling Event 1. The sample was pulled from a more potent portion of the subsidiary working face pile. Odors were observed to smell similar to residential trash.

### 3.2.3.3 Laboratory Analytical Results

Laboratory analytical results are presented in the following tables and figures. The laboratory reports are included in Appendix B.

#### 3.2.3.3.1 Reduced Sulfur Compound Analysis (ASTM D5504) Results

Reduced sulfur compound laboratory analytical results are summarized in Table 3-24 for ZWED, RWF, and NIRRP. The greatest sulfur compound concentrations were measured at the RWF Primary Clarifier Launderers and Bioreactor Mixing Zone sources as well as the Newby landfill gas source.

**Table 3-24. Reduced Sulfur Compound Analytical Results**

Location	Reduced Sulfur Compounds (ppbv) <sup>a</sup>							
	CDS	CS	DMDS	DMS	H <sub>2</sub> S	MM	PM	BM
<b>ZWED</b>								
Interior Space	3.6	ND	ND	ND	8.3	ND	ND	ND
Biofilter 1	ND	ND	ND	ND	ND	ND	ND	ND
<b>RWF</b>								
East Primaries	510	470	9.3	410	770	1,100	ND	ND
Bioreactors (Aerated)	ND	ND	ND	11	8.8	ND	ND	ND
Bioreactors (Mixing)	73	34	8.3	230	39	1,100	7.7	20
<b>NIRRP</b>								
Landfill Gas	190	690	ND	2000	350,000	2,500	ND	ND

Notes:

<sup>a</sup> Per ASTM D 5504. Only those compounds measured (i.e., above Method Reporting Limit) are shown.

ND = non-detect, CDS = carbon disulfide, CS = carbonyl sulfide, DMDS = dimethyl disulfide, DMS = dimethyl sulfide, MM = methyl mercaptan, PM = n-propyl mercaptan, BM = tert-butyl mercaptan

**3.2.3.3.2 General Odor Analysis (ASTM E769-04) Results**

Odor panel analysis results are summarized in Table 3-25 for ZWED, RWF, and NIRRP. The odor concentrations were measured at the RWF Primary Clarifier Launderers and Bioreactor Mixing Zone sources as well as the Newby Island landfill gas source. Newby Island composting piles also exhibited high odors with a significant hedonic tone value. Laboratory results obtained for this sampling event indicated the following:

- ZWED samples:
  - Relatively low D/T values
  - Low sulfur compounds
  - Low VOCs (below odor thresholds)
- RWF samples:
  - High D/T at Primaries and mixing zone of Bioreactors
  - Higher than normal methyl mercaptans at both primaries and bioreactors
  - Low VOCs (below odor thresholds)
- NIRRP samples:
  - High D/T values at fresh compost piles, working face, and landfill gas
  - Overall low VOCs (below odor thresholds)

**Table 3-25. Odor Panel Analysis Results**

Sample Description	D/T	RT	I	HT	DR	Comments
Biofilter 1 ZWED	110	60	1.5	-0.2	---	0
ZWED Interior Space	320	190	2.7	-0.9	---	0
East Primaries	18,000	9,000	5.2	-3.6	---	0

Sample Description	D/T	RT	I	HT	DR	Comments
Bioreactors (Mixing Zone)	8,000	4,100	4.6	-3.6	---	0
Bioreactors (Aerobic Zone)	160	85	2.5	-1.4	---	0
Lagoons	120	65	2.3	-1.1	---	0
Composting Piles - NIRRP	6,000	3,300	5.0	-3.5	---	0
Landfill Working Face NISL	1,200	610	3.1	-2.3	---	0
Landfill Gas	160,000	78,000	---	---	---	Field sample diluted 10:1 for threshold evaluation. Sample not observed for Intensity or Characterization.
MRF	120	65	0.9	+0.3	---	0

Notes:

DR = dilution ratio; I = intensity; RT = recognition to threshold

Figures 3-36 through 3-38 are odor descriptor graphics showing the average sensation of the odor descriptors (on a scale 1 to 10). General findings are as follows:

- The ZWED interior exhibited lower overall odor intensities when compared to the previous Sampling Event 1 and Sampling Event 2.
- The RWF bioreactor exhibited strong odors primarily in the sulfur category.
- NIRRP compost pile exhibited strong odors in primarily the decay category and to a lesser extent in the fruit and rotten vegetable (organic reduced sulfur) category.



Figure 3-36. Odor Descriptors for ZWED Interior

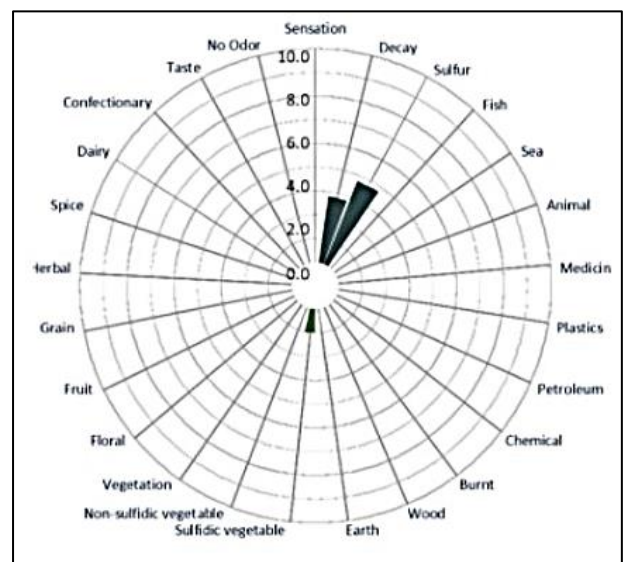

Figure 3-37. Odor Descriptors for RWF Bioreactor

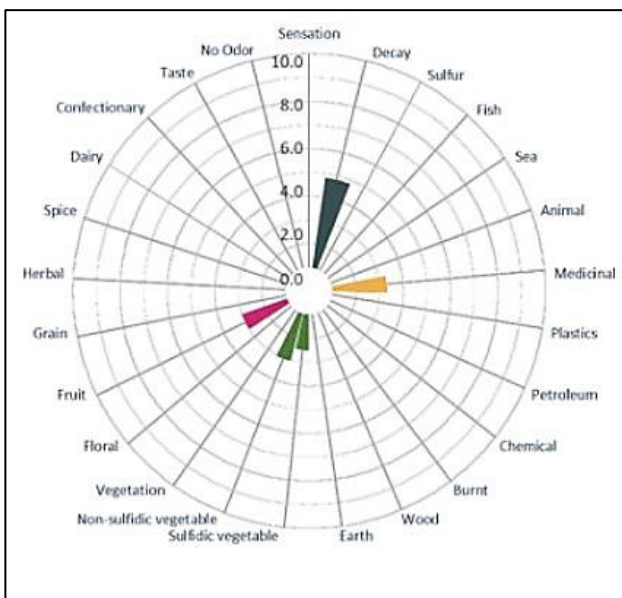

Figure 3-38. Odor Descriptors for NIRRP Compost Pile

### 3.2.3.3 Aldehyde Analysis (TO-11A) Results

Aldehyde analytical results are summarized in Table 3-26 for ZWED, RWF, and NIRRP. Significant levels of aldehydes were found at five sources: the ZWED interior space, the RWF bioreactor mixing zone, the NIRRP working face, the NIRRP compost piles, and NIRRP landfill gas. Other sources exhibited either no aldehydes or only a small number or concentration of aldehydes. No carboxylic acid analysis could be conducted for Sampling Event 3 because ALS discontinued that specific test methodology.

Table 3-26. Aldehyde Analytical Results

Location	Aldehydes (ppbv) <sup>a</sup>								
	F	A	P	BY	BZ	I	V	T	H
<b>ZWED</b>									
Interior Space	25	13	16	2.3	0.31	2.6	0.49	ND	2.6
Biofilter 1	ND	1.2	31	ND	ND	ND	ND	ND	ND
<b>RWF</b>									
Bioreactors (Aerobic)	0.88	0.73	35	ND	ND	ND	ND	ND	ND
Bioreactors (Mixing)	1.0	5.0	8.8	ND	ND	ND	ND	ND	ND
<b>NIRRP</b>									
Landfill Working Face	ND	ND	5.3	5.4	3.7	3.7	0.87	0.77	3.4
Compost Piles	40	84	3.6	6.9	5.8	13	ND	1.5	6.9
Landfill Gas	ND	440	210	220	74	15	83	ND	12

Notes:

<sup>a</sup> Per TO-11A. Only those compounds measured (i.e., above Method Reporting Limit) are shown.

ND = non-detect, F = formaldehyde, A = acetaldehyde, P = propionaldehyde, BY = butyaldehyde, BZ = benzaldehyde, I = isovaleraldehyde, V = valeraldehyde, T = o-tolualdehyde, H=n-hexaldehyde

### 3.2.3.3.4 VOC Analysis (TO-17) Results

VOC analysis results are summarized in Tables 3-27 through Table 3-33 for ZWED, RWF, and NIRRP. Multiple VOCs were observed at most sources; however, only a few exhibited high concentrations that approached the respective OTC. In almost every case, the measured concentrations fell below the respective OTC and therefore VOCs are considered less impactful when compared to other odorant groupings analyzed.

**Table 3-27. VOC Analytical Results (1 of 7)**

Location	VOCs (ppbv) <sup>a</sup>						
	CFC-12	CM	VC	1,3-B	CE	E	An
<b>ZWED</b>							
Interior Space	<1.3	<3.0	<2.4	<2.8	<2.4	<3.3	8.5
Biofilter 1	<1.2	<3.0	<2.4	<2.8	<2.3	580	20
<b>RWF</b>							
Bioreactors (Aerobic)	<1.2	<3.0	<2.4	<2.8	<2.3	<3.3	<2.6
Bioreactors (Mixing)	<1.2	<2.8	<2.3	<2.6	<2.2	<2.1	<2.4
<b>NIRRP</b>							
Landfill Working Face	<1.2	<3.0	<2.4	<2.8	<2.3	350	<2.6
Compost Piles	<1.2	<3.0	<2.4	<2.8	<2.3	4.5	<2.6
Landfill Gas	<5.1	<12	<9.8	<11	<9.5	130	500

Notes:

<sup>a</sup> Per TO-11A. Only those compounds measured (i.e., above Method Reporting Limit) are shown.

ND = non-detect, CFC-12 = dichlorodifluoromethane, CM = chloromethane, VC = vinyl chloride, 1,3-B = 1,3-butadiene, CE = chloroethane, E = ethanol, An = acetonitrile

**Table 3-28. VOC Analytical Results (2 of 7)**

Location	VOCs (ppbv) <sup>a</sup>					
	CD	MC	1,2-D	1,1-D	M t-BE	2-B
<b>ZWED</b>						
Interior Space	<2.0	<1.8	<1.5	<1.5	<1.7	28
Biofilter 1	<2.0	4.3	<1.6	<1.5	<1.7	<2.1
<b>RWF</b>						
Bioreactors (Aerobic)	<2.0	<1.8	<1.6	<1.5	<1.7	<2.1
Bioreactors (Mixing)	<1.9	<1.7	<1.5	<1.4	<1.6	<2.0
<b>NIRRP</b>						
Landfill Working Face	<2.0	<1.8	<1.5	<1.5	<1.7	<2.1
Compost Piles	<2.0	<1.8	<1.5	<1.5	<1.7	37
Landfill Gas	47	<7.2	<6.3	<6.2	<6.9	410

Notes:

<sup>a</sup> Per TO-11A. Only those compounds measured (i.e., above Method Reporting Limit) are shown.

ND = non-detect, 2-P = 2-propanol, MC = methylene chloride, CD = carbon disulfide, 1,2-D = trans-1,2-dichloroethene, 1,1-D = 1,1-dichloroethane, M t-BE = methyl tert-butyl ether, 2-b = 2-butanone

**Table 3-29. VOC Analytical Results (3 of 7)**

Location	VOCs (ppbv) <sup>a</sup>								
	1,2-DC	n-Hx	CF	THF	1,2-DC	1,1,1-TCE	Bz	CTC	CHx
<b>ZWED</b>									
Interior Space	<1.5	1.9	<1.2	2.4	<1.5	<1.1	<1.9	<0.97	<1.8
Biofilter 1	<1.6	<1.8	<1.3	2.5	<1.5	<1.1	<1.9	<0.99	<1.8
<b>RWF</b>									
Bioreactors (Aerobic)	<1.6	<1.7	<1.3	<2.1	<1.5	<1.1	<1.9	<0.98	<1.8
Lagoons (Mixing)	<1.5	<1.6	<1.2	<2.0	<1.4	<1.1	<1.8	<0.92	<1.7
<b>NIRRP</b>									
Landfill Working Face	<1.5	<1.7	<1.2	<2.1	<1.5	<1.1	<1.9	<0.97	<1.8
Compost Piles	<1.5	<1.7	<1.2	<2.1	<1.5	<1.1	<1.9	<0.97	<1.8
Landfill Gas	<6.3	<7.1	<5.1	220	18	<4.6	190	<4.0	<7.3

Notes:

<sup>a</sup> Per TO-11A. Only those compounds measured (i.e., above Method Reporting Limit) are shown.

ND = non-detect, 1,2-DC = cis-1,2-dichloroethene, n-Hx = n-hexane, CF = chloroform, THF = tetrahydrofuran, 1,2-DC = 1,2-dichloroethane, 1,1,1-TCE = 1,1,1-trichloroethane, Bz = benzene, CTC = carbon tetrachloride, CHx = cyclohexane

**Table 3-30. VOC Analytical Results (4 of 7)**

Location	VOCs (ppbv) <sup>a</sup>						
	1,2-DCP	BCM	TCE	n-Hp	1,3-DCP	4M-2P	1,3-DCP
<b>ZWED</b>							
Interior Space	<1.3	<0.91	<1.1	2.3	<1.3	8.2	<1.3
Biofilter 1	<1.3	<0.93	<1.2	4.2	<1.4	<1.5	<1.4
<b>RWF</b>							
Bioreactors (Aerobic)	<1.3	<0.92	<1.1	<1.5	<1.4	<1.5	<1.4
Bioreactors (Mixing)	<1.2	<0.87	<1.1	<1.4	<1.3	<1.4	<1.3
<b>NIRRP</b>							
Landfill Working Face	<1.3	<0.91	<1.1	<1.5	<1.3	<1.5	<1.3
Compost Piles	<1.3	<0.91	<1.1	<1.5	<1.3	<1.5	<1.3
Landfill Gas	<5.1	<3.7	7.5	51	<5.5	84	<5.5

Notes:

<sup>a</sup> Per TO-11A. Only those compounds measured (i.e., above Method Reporting Limit) are shown.

ND = non-detect, 1,2-DCP = 1,2-dichloropropane, BCM = bromodichloromethane, TCE = trichloroethane, n-Hp = n-heptane, 1,3-DCP = cis-1,3-dichloropropene, 4M-2P = 4-Methyl-2-pentanone, 1,3-DCP = trans-1,3-dichloropropene



**Table 3-31. VOC Analytical Results (5 of 7)**

Location	VOCs (ppbv) <sup>a</sup>							
	T	2-Hx	DCM	TCE	1,2-DBM	CBz	EBz	m,p-X
<b>ZWED</b>								
Interior Space	14	<1.5	<0.72	<0.90	<0.79	<1.3	2.7	10
Biofilter 1	<1.6	<1.5	<0.73	1.2	<0.81	<1.3	<1.4	5
<b>RWF</b>								
Bioreactors (Aerobic)	<1.6	<1.5	<0.72	<0.91	<0.80	<1.3	<1.4	<1.4
Bioreactors (Mixing)	15	<1.4	<0.68	<0.86	<0.76	<1.3	<1.3	<1.3
<b>NIRRP</b>								
Landfill Working Face	1.7	<1.5	<0.72	<0.90	<0.79	<1.3	<1.4	3.4
Compost Piles	2.3	<1.5	<0.72	<0.90	<0.79	<1.3	3.5	14
Landfill Gas	570	<6.1	<2.9	25	<3.3	<5.4	470	740

Notes:

<sup>a</sup> Per TO-11A. Only those compounds measured (i.e., above Method Reporting Limit) are shown.

ND = non-detect, T = toluene, 2-Hx = 2-hexanone, DCM = dibromochloromethane, 1,2-DBM = dibromoethane, TCE = tetrachloroethane, CBz = chlorobenzene = EBz = ethylbenzene, m,p-X = m,p-xylenes

**Table 3-32. VOC Analytical Results (6 of 7)**

Location	VOCs (ppbv) <sup>a</sup>							
	BF	St	1,1,2,2-TCE	o-Xy	1,3,5-TMB	1,2,4-TMB	1,3-DCB	1,4-DCB
<b>ZWED</b>								
Interior Space	<0.59	1.8	<0.89	2.5	<1.2	<1.2	<1.0	<1.0
Biofilter 1	<0.60	<1.5	<0.90	4.1	<1.3	1.7	<1.0	7
<b>RWF</b>								
Bioreactors (Aerobic)	<0.60	<1.4	<0.90	<1.4	<1.3	<1.3	<1.0	<1.0
Bioreactors (Mixing)	<0.56	<1.4	<0.85	<1.3	<1.2	<1.2	<0.97	<0.97
<b>NIRRP</b>								
Landfill Working Face	<0.59	<1.4	<0.89	1.4	<1.2	2.8	<1.0	1.3
Compost Piles	<0.59	5.5	<0.89	5.4	8.8	12	<1.0	2.1
Landfill Gas	<2.4	190	<3.6	550	220	380	<4.2	510

Notes:

<sup>a</sup> Per TO-11A. Only those compounds measured (i.e., above Method Reporting Limit) are shown.

ND = non-detect, BF = bromoform, St = styrene, o-Xy = o-xylene, 1,1,2,2-TCE = 1,1,2,2-tetrachloroethane, 1,3,5-TMB = 1,3,5-Trimethylbenzene, 1,2,4-TMB = 1,2,4-Trimethylbenzene, 1,3-DCB = 1,3-Dichlorobenzene, 1,4-DCB = 1,4-Dichlorobenzene

**Table 3-33. VOC Analytical Results (7 of 7)**

Location	VOCs (ppbv) <sup>a</sup>	
	1,2,4-TCB	
<b>ZWED</b>		
Interior Space	<0.82	
Biofilter 1	<0.84	
<b>RWF</b>		
Bioreactors (Aerobic)	<0.83	
Bioreactors (Mixing)	<0.78	
<b>NIRRP</b>		
Landfill Working Face	<0.82	
Compost Piles	<0.82	
Landfill Gas	<3.4	

Notes:

<sup>a</sup> Per TO-11A. Only those compounds measured (i.e., above Method Reporting Limit) are shown.

ND = non-detect, 1,24-TCB = 1,2,4 trichlorobenzene

### 3.2.3.4 Odor Profile Method Results

#### 3.2.3.4.1 OPM Intensity Results

OPM intensity results are summarized in Table 3-34. Key findings are as follows:

- Rancid (carboxylic acids), fecal, sweet (aldehyde), and rotten vegetables (reduced organic sulfur compounds) are all prevalent odorant types found similar to Sampling Event 1 findings.
- Musty odorants (e.g., 2-methyl isoborneol, 2-isopropyl-3-methoxypyrazine) were observed, but at lower intensity levels. This is similar to what was observed during Sampling Event 1.
- ZWED downstream exhibited high intensities characterized as rancid and sweet.

**Table 3-34. Results Odor Characterization by OPM for Sampling Event 3**

Location	Odor Characteristics and Intensities
ZWED Biofilter	fecal 1.5±1.9, rotten veg 3.5±2.5
ZWED Interior Space	rancid 5.5±1.9, sweet 2.0±2.3
ZWED Upwind	musty 1.8±1.7
RWF East Primaries	rotten egg 4.0±3.3, fecal 4.5±3.0; other odor note: ammonia, rotten veg
RWF Bioreactors (Aerobic Zone)	musty 2.5±1.9; other odor note: fecal
RWF Bioreactors (Mixing Zone)	fecal 4.0±2.8, rotten egg 3.0±3.8; other odor note: ammonia, rancid, rotten veg
RWF Lagoons	other odor note: fecal, musty
NIRRP Compost Piles	pine 4.5±1.0, rancid 3.0±2.6
NIRRP Landfill Working Face	rancid 4.5±1.9, other odor note: sweet, rotten veg, musty

Location	Odor Characteristics and Intensities
NIRRP Landfill Gas	rotten egg 5.0±2.0, rotten veg 2.5±3.0; other note: fecal
NIRRP Landfill Downwind	No odor reported
NIRRP Landfill Upwind	No odor reported
RWF Downwind	No odor reported
RWF Upwind	No odor reported
ZWED Downwind	rancid 3.0±1.2, sweet 1.0±1.2; other odor note: musty

### 3.2.3.4.2 Persistency Curves

Figures 3-39 through 3-47 provide persistency curves for the various sources sampled during Sampling Event 3. The key findings from the persistency curves are as follows:

- The ZWED biofilter source exhibited primarily fecal and rotten egg odorants with persistent musty odorants.
- The ZWED indoor source exhibited a combination of rancid and sweet odorants at high intensity levels with lower intensity musty odorants.
- ZWED upwind was primarily musty, which may be due to Bay mud sources.
- The RWF bioreactor mixing zone source exhibited primarily fecal and rotten egg odorants at moderate intensity levels.
- The RWF primary effluent weirs and box source exhibited a combination of fecal and rotten egg odorants at high intensity levels, corroborating the analytical findings.
- The NIRRP working face source exhibited primarily rancid at high intensity levels, different than the Sampling Event 1 findings which included both rancid and sweet.
- The NIRRP compost pile source exhibited primarily pine and rancid at relatively high intensities. Observers noted the smell to be similar to chewing tobacco.
- The NIRRP landfill gas source was observed to be rotten vegetable at high intensity levels. This was likely due to the strength of this odorant type that likely masked other odorants known to exist from the various analytical testing results. Landfill gas is designed to be contained in a regulated and engineered system and sent to a flare to be flared or burned; however, leaks at landfill gas wells have been detected.

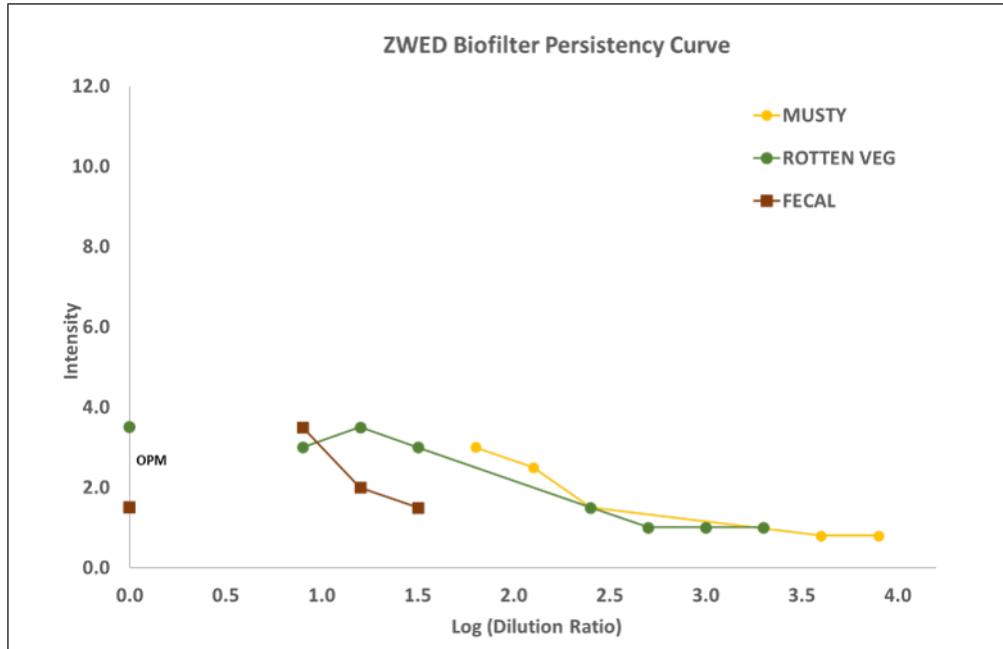

**ZWED Biofilter**

- Fecal and rotten vegetable predominant at source
- Musty predominant further away
- Source does not appear to be significant offsite impactor

Figure 3-39. ZWED Biofilter OPM Persistency Curves

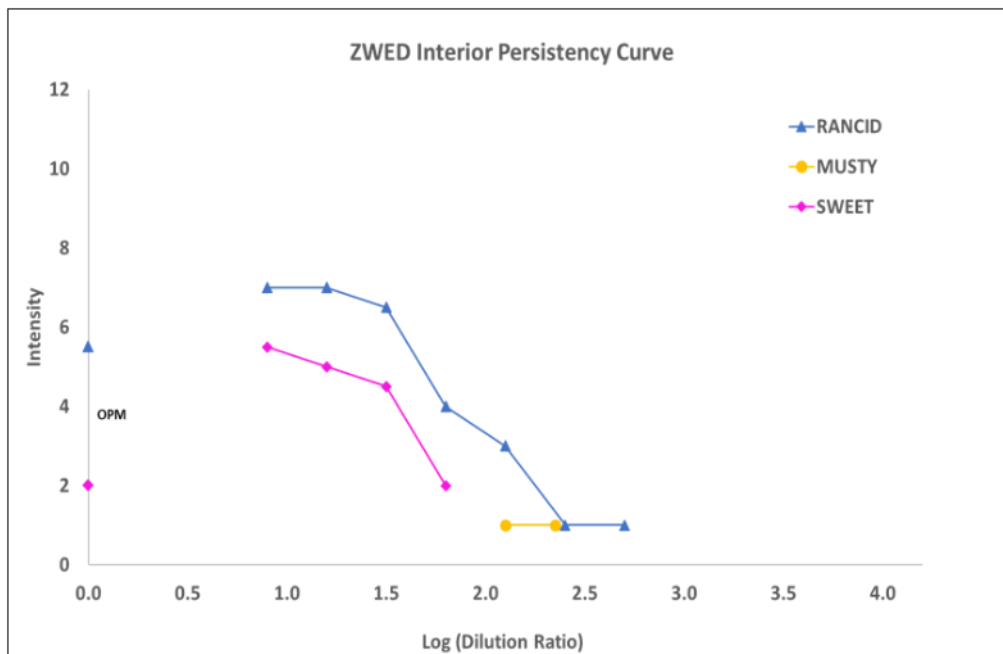

**ZWED Interior**

- Rancid and sweet predominant at source
- Musty and rancid predominant further away
- Source can be significant offsite impactor if not contained

Figure 3-40. ZWED Interior OPM Persistency Curves

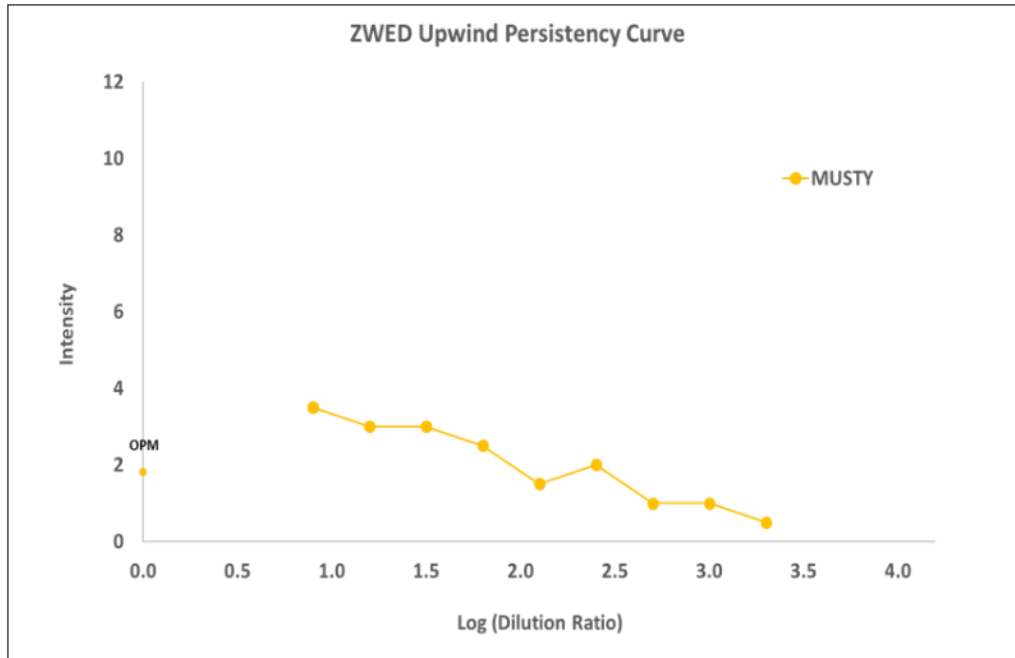

**ZWED Upwind**

- Musty – Bay odors with MIB or other musty odorants?

Figure 3-41. ZWED Upwind OPM Persistency Curves

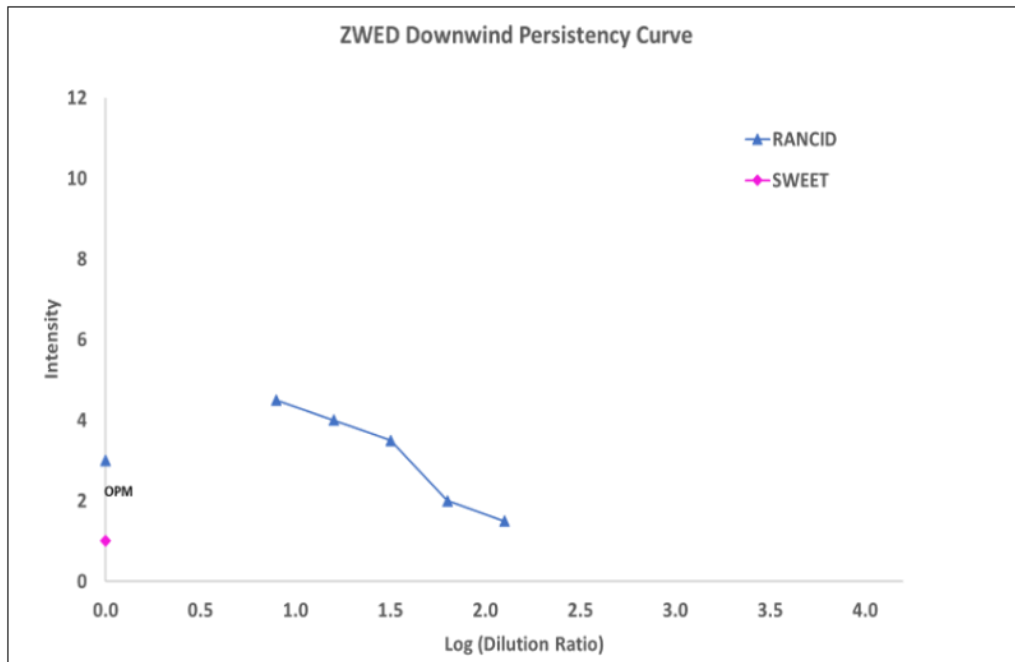

**ZWED Downwind**

- Rancid – Considered a significant source for offsite odor impacts

Figure 3-42. ZWED Downwind OPM Persistency Curves

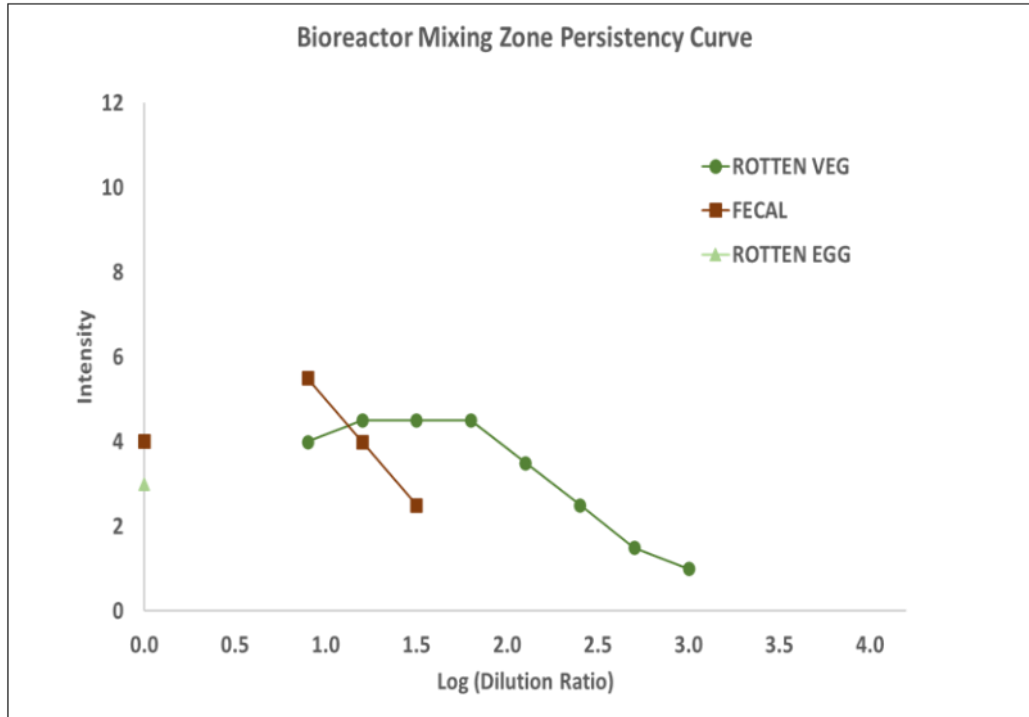

RWF Bioreactor Mixing Zone

- Fecal and rotten vegetable predominant at source
- Rotten vegetable most predominant further away
- Agrees with lab results – high MM

Figure 3-43. Bioreactor Mixing Zone OPM Persistency Curves

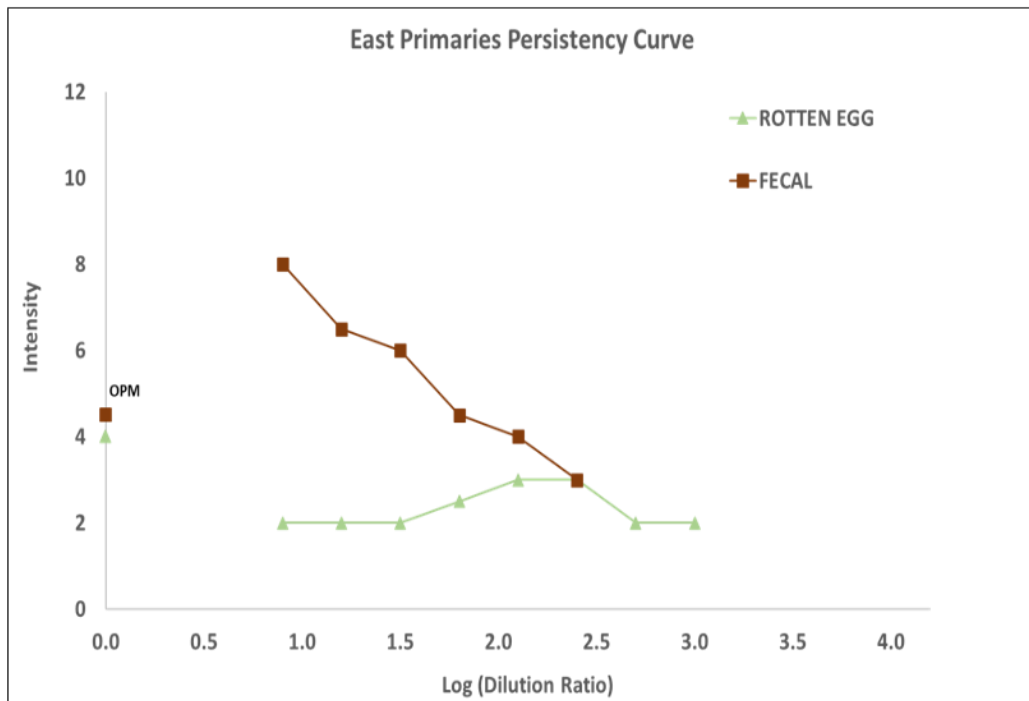

RWF Primary Effluent Launderers/Box

- Fecal and sulfur predominant at source
- Sulfur/rotten egg most predominant further away
- Source may be significant offsite impactor

Figure 3-44. East Primaries OPM Persistency Curves

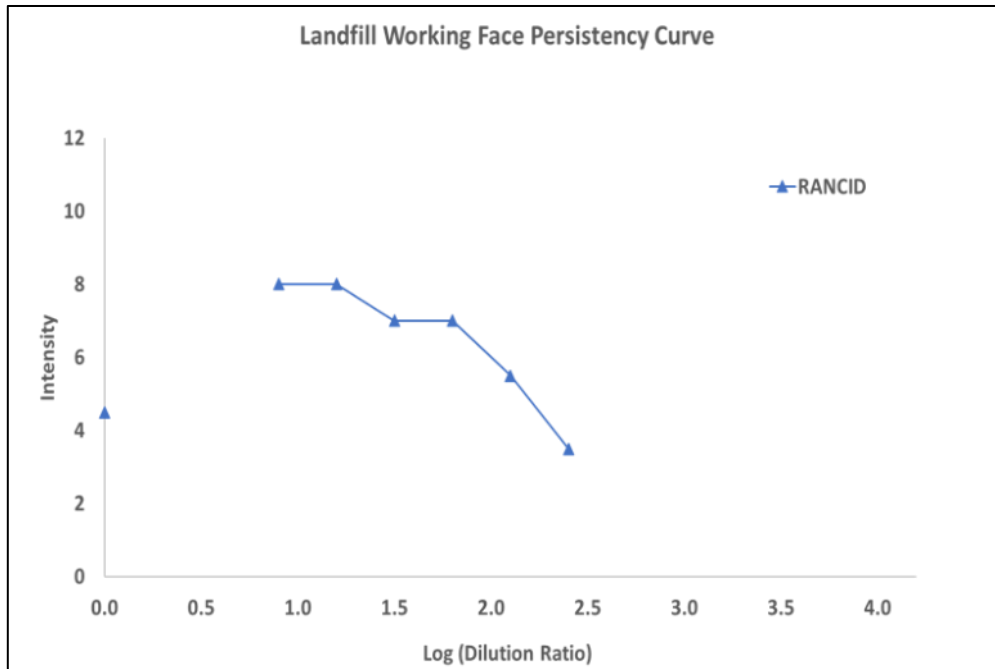

NIRRP Working Face

- Rancid predominant at source
- Different from October
- October exhibited rancid and sweet and musty further away
- Source may be significant offsite impactor

Figure 3-45. Landfill Working Face OPM Persistency Curves

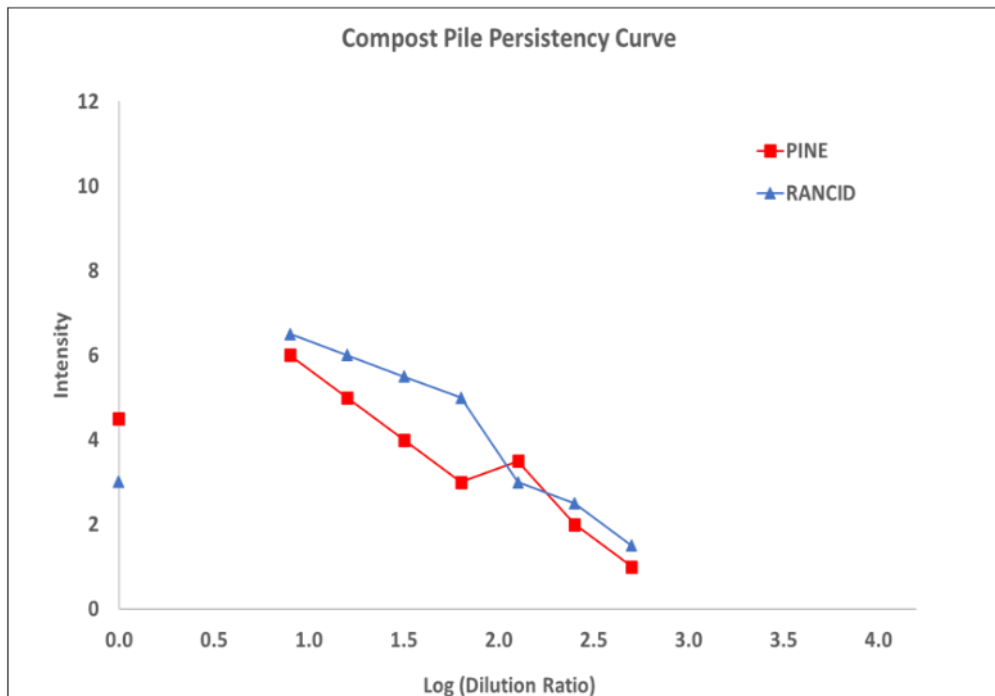

NIRRP Compost Pile

- Rancid and pine predominant at source
- Agrees with lab results
- Source may be significant offsite impactor
- Compost pile sampled is the 24-hour pile after grinding prior to the rows with the biolayer. Smelled like chewing tobacco.

Figure 3-46. Compost Pile OPM Persistency Curves

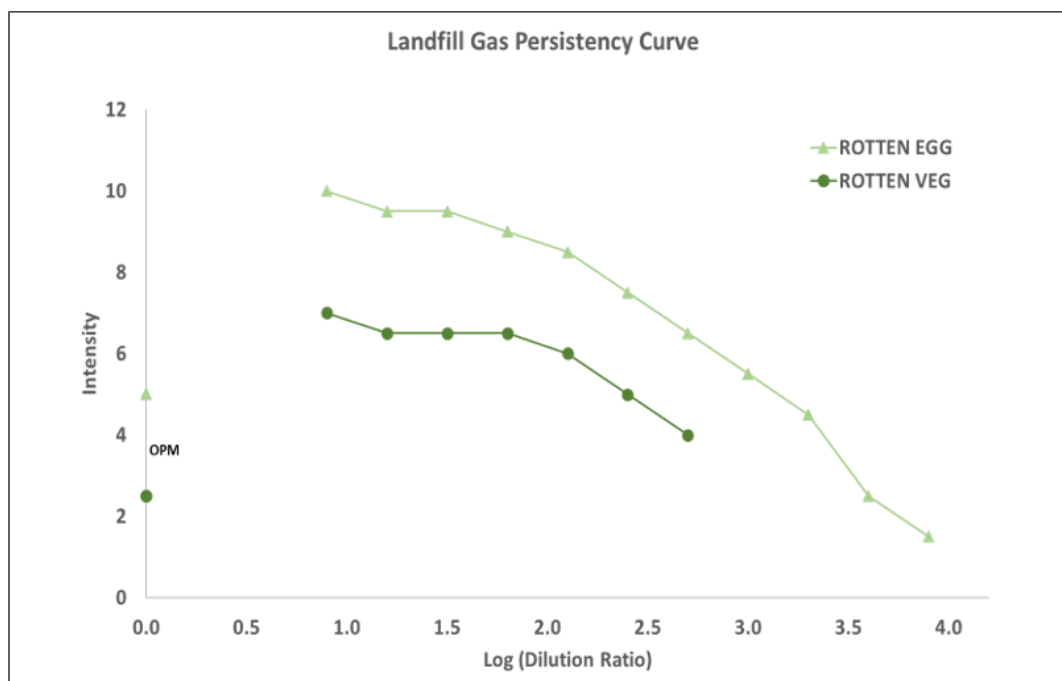

#### NIRRP Landfill Gas

- Rotten egg and rotten vegetable are predominant at source
- Source diluted 7.5:1
- Source may be significant offsite impactor if not properly contained

Figure 3-47. Landfill Gas OPM Persistency Curves

#### 3.2.3.4.3 Odor Activity Value Summary

Figures 3-48 through 3-50 provide a comparison of OAVs for all measured sources at ZWED, RWF, and NIRRP, respectively. Any OAV that exceeds 10 is considered to be a possible nuisance odor as it represents an odorant that requires a minimum dilution of 10:1 to reduce the strength of the odorant to below its OTC. Therefore, the OAV action level is equal to 10 and is shown as dashed red line below. Note the following:

- Sulfur-based compounds (characterized as rotten eggs, rotting vegetables) are shown as blue.
- Aldehydes (characterized as sweet) are shown as red.
- Carboxylic acids (characterized as rancid) are shown as yellow.
- VOCs (characterization varies) are shown as green.
- Amine (characterized as fishy) are shown as brown.

The following conclusions are made:

- The ZWED Biofilter was performing well. There was one hit of propionaldehyde (sweet, ester).
- The ZWED Interior Space exhibited a mixture of sulfur, rancid, and sweet odors.
- One hit of VOC was observed in the ZWED Interior Space (2,3-butanedione – butter, rancid).
- All measured sources at the RWF exhibited mainly sulfur odors.
- Odors from the RWF Bioreactors (aerated) were minor except for propionaldehyde (sweet, ester).
- Methyl Mercaptans were high for RWF primaries and bioreactors (mixing zone). Possible fermentation is occurring.
- NIRRP exhibited a wide variety of odorant types.
- Landfill gas was a dominant source at the NIRRP. This source, although contained in a regulated and engineered system and sent to the flare, can exhibit specific release points where gas well leaks occur.



- Odors from the working face of the landfill (traditional waste) were less intense than the odors observed from the ZWED residuals waste during the October sampling event. The waste stream was primarily residential trash waste as described previously.
- The NIRRP composting area was high in aldehydes. Woody odorants were moderate to low.

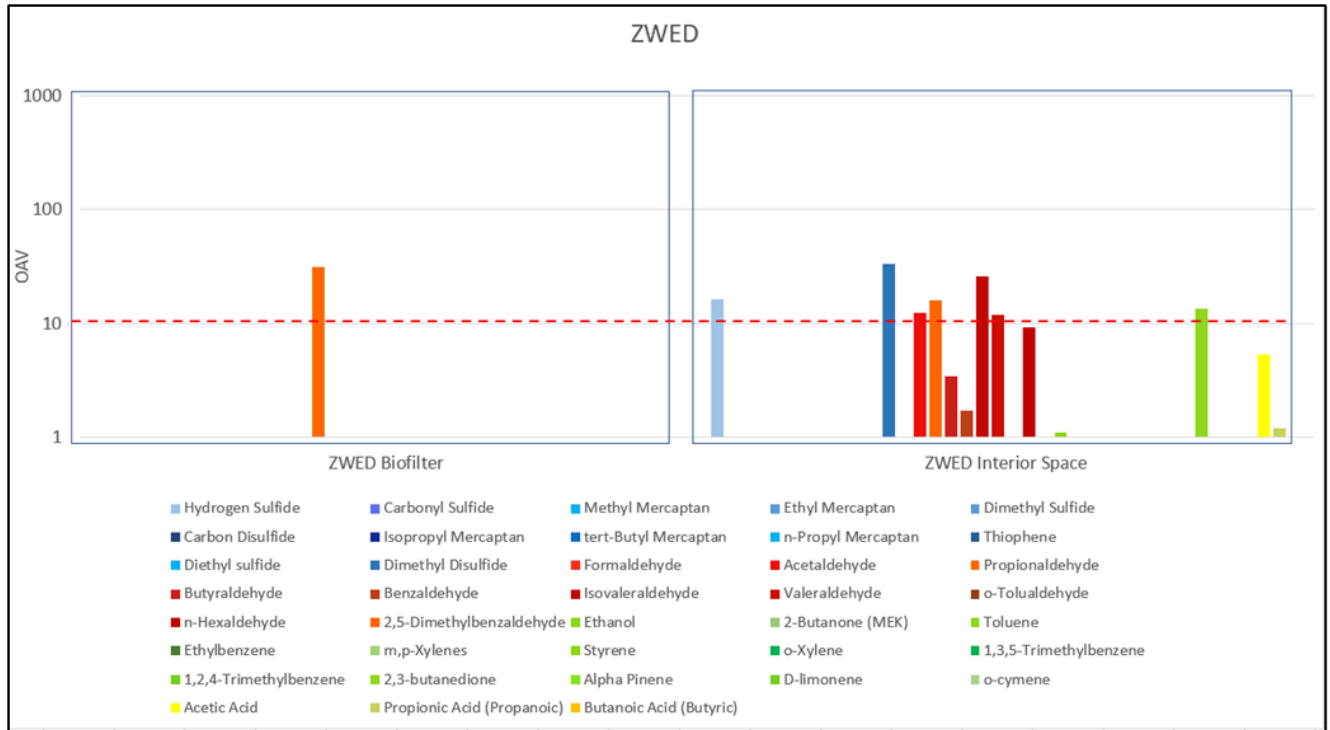

Figure 3-48. Sampling Event 3 OAV Comparison for ZWED

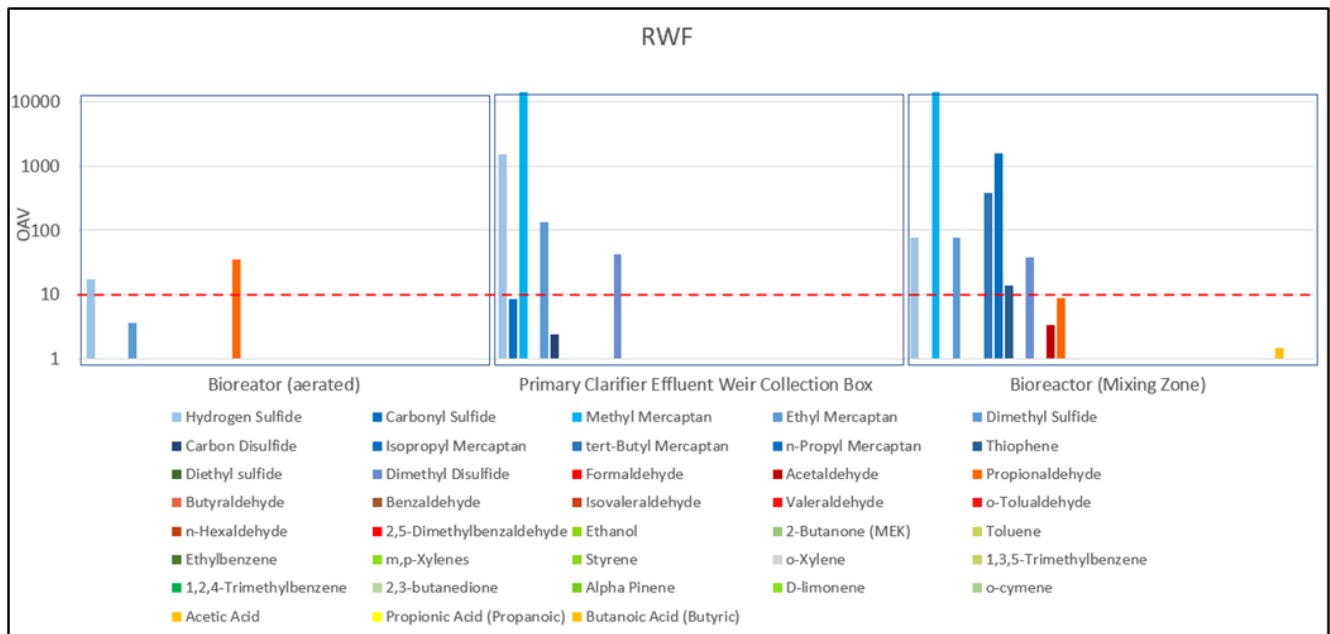

Figure 3-49. Sampling Event 3 OAV Comparison for RWF

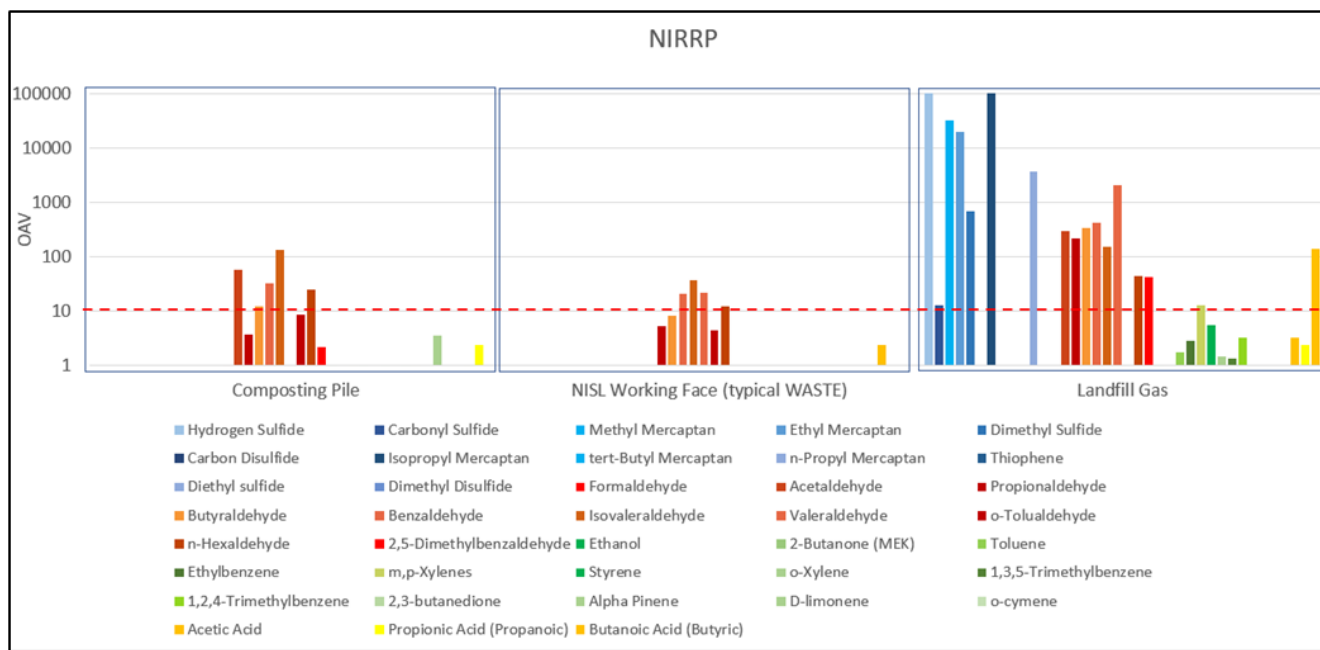

Figure 3-50. Sampling Event 3 OAV Comparison for NIRRP

### 3.2.3.5 Field Odor Assessment Results

Continuous hydrogen sulfide monitoring and field odor assessment results are presented in this section.

#### 3.2.3.5.1 Continuous H<sub>2</sub>S Monitoring

Figures 3-51 and 3-52 illustrate the H<sub>2</sub>S trends for the ZWED biofilter and interior space and the RWF primary effluent box and estuary, respectively, from May 18, 2021, to May 25, 2021. For Figure 3-51, the first part of the graph until May 21 reflects the Acrulog placement at the ZWED biofilter while the remainder reflects the ZWED interior space. Similarly, for Figure 3-52 the first part of the graph until May 21 reflects the Acrulog placement at the primary effluent box while the remainder reflects the estuary.

The following conclusions are made:

- ZWED Biofilter exhibited only a few small hits below 0.5 ppm
- ZWED Interior Space exhibited:
  - multiple hits > 1 ppm
  - morning and evening spikes in addition to midday peaks
  - spikes likely due to decaying food waste
- RWF Primaries exhibited:
  - afternoon and evening H<sub>2</sub>S spikes
  - high H<sub>2</sub>S (but lower than the H<sub>2</sub>S observed in Sample Event 1)
  - spikes > 35 ppm

Turbulence is a significant contributor in the observance of these spikes

- Estuary only exhibited a few small hits

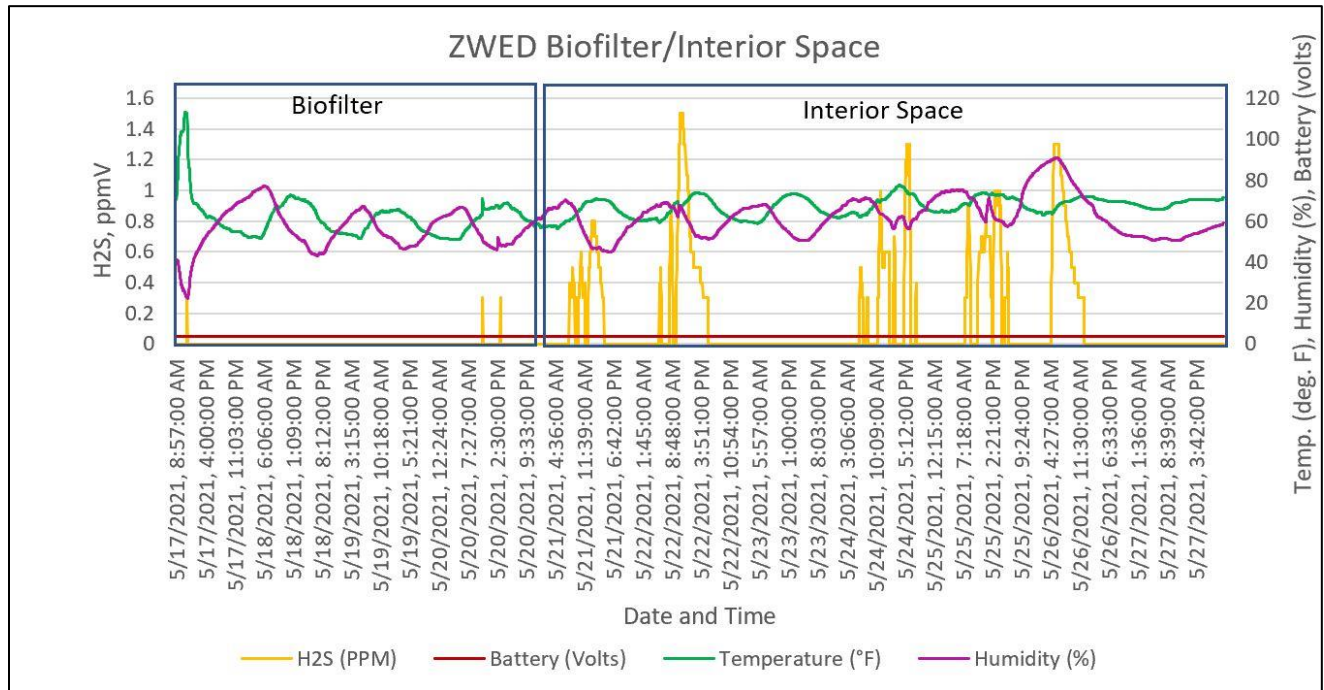

Figure 3-51. Sampling Event 3 H<sub>2</sub>S Continuous Monitoring Results for ZWED Biofilter and Interior Space

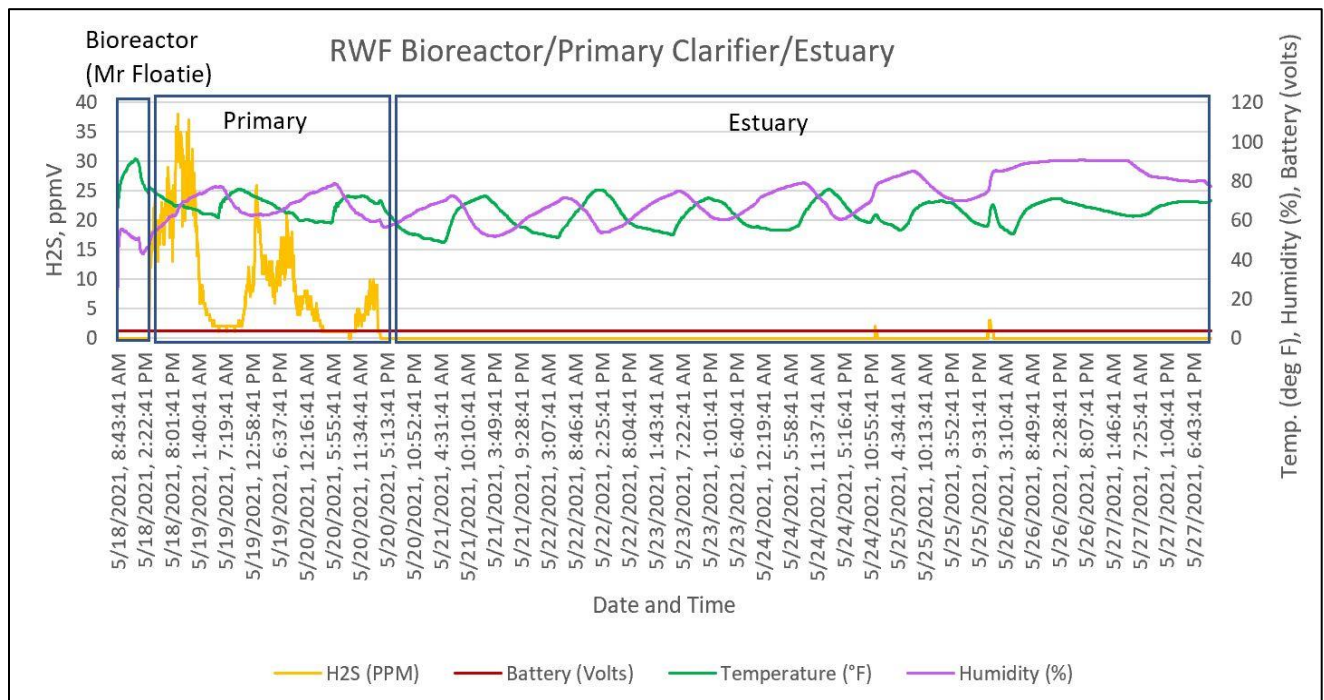

Figure 3-52. Sampling Event 3 H<sub>2</sub>S Continuous Monitoring Results for RWF Bioreactor, Primary Clarifier, and Estuary

### 3.2.3.5.2 Field Odor Assessment Results

The field odor assessment using the Scentroid MS100 field olfactometer undertaken in the neighboring communities as well as near the main odor emitting facilities showed that:

- Odors were observed in the community mainly at Marilyn Drive, Milmont Drive, and Renaissance Road (refer to Section 3.3.1).
- Strong odors were observed near each of the main odor emitting facilities (ZWED, NIRRP, RWF).
- The odors directly downstream of the ZWED biofilter (Biofilter#1) sampled on Monday May 17 were very strong and very unpleasant with a character similar to the ZWED interior (sampled air is most likely the foul air from ZWED interior as sample location was directly downstream of ZWED building and has a leak in roof).
- The odors directly downstream of the RWF Bioreactors sampled on Tuesday May 18 were relatively strong compared to the RWF Primaries.
- The odors directly downstream of the grinded fresh organic material pile next to the compost piles were relatively very strong and the strength and unpleasantness were comparable to the odors downstream of the landfill working face and a landfill gas collection point.

### 3.2.4 Sampling Event 4 – Summer 2021

#### 3.2.4.1 Description

The sampling event took place during the week of August 30 – September 1, 2021. The sampling schedule planned was as follows:

- Monday: Samples were collected at RWF
- Tuesday: Samples were collected at NIRRP, Upwind of Lagoons/Bay, Downwind of RWF
- Wednesday: Samples were collected Downwind of NIRRP (Community sample near Milmont Drive)

Weather:

- Morning light winds out of south-southeast
- Afternoon winds out of northwest
- Temperature: High: 80°F and Average Daily: 64°F

The compost area at NIRRP was sampled specifically at the ground green waste food stockpile. This pile remains for up to 24 hours before moved and placed on the aerated static piles (ASPs).

Table 3-35 provides the sampling matrix for this event.

**Table 3-35. Sampling Event 4 Matrix**

Sampling Set	Source ID	Source	Number of Samples per event	Odor Constituent, Sample Collection and Sample Analysis Method					
				Odor Profile Method (OPM)	Montrose	Reduced Sulfur	Olfactometry Laboratory (OU/m <sup>3</sup> )	Spot H <sub>2</sub> S	Olfactometer Field (D/T)
				Teflon Bag	Teflon Bag	Tedlar Bag	Tedlar Bag	In-field	In-field
				Modified Standard Method 2170: Flavor Profile Analysis Method (applied to air)	PTR Technology	ASTM D5504 Method by Modified GC/SCD	ASTM E679-04 Standard of Practice presentation rate per EN 13725	Jerome Meter	Scentroid SM-100
<b>RWF</b>	1	Lagoons	1	X <sup>a</sup>	X <sup>b</sup>	See Note <sup>c</sup>	X	X	
<b>NIRRP</b>	2	Compost Piles (ground food stock)	1	X <sup>a</sup>	X <sup>b</sup>	X	X	X	
	3	Biosolids Stockpile	1	X <sup>a</sup>	X <sup>b</sup>	See Note <sup>c</sup>	X	X	
<b>Upwind</b>	4		1	X <sup>a</sup>	X <sup>b</sup>	See Note <sup>c</sup>	See Note <sup>c</sup>	See Note <sup>c</sup>	X
<b>Downwind</b>	5		1	See Note <sup>c</sup>	X <sup>b</sup>	See Note <sup>c</sup>	See Note <sup>c</sup>	See Note <sup>c</sup>	X

Notes: This sampling matrix may be updated based on BAAQMD feedback.

<sup>a</sup> Collect three 20-L samples for UCLA (to perform the OPM, generate persistency curves, and quantify musty odors) Montrose (to perform an initial scan to identify the wide range of individual compounds and specific markers of these odor sources).

<sup>b</sup> Collect one 10-L sample for shipping to Montrose (to perform scan to identify the wide range of individual compounds and specific markers using PTR technology).

<sup>c</sup> Specific analysis/method not performed. Only analyses/methods deemed necessary for the specific source (i.e., matching expected odorant emissions or considered non-redundant to other analyses/methods listed) are to be performed. Analysis selection based on past studies, previous sampling event results, best engineering judgment, project budget restraints, or based on the particular source categorized as either critical or non-critical. For example, NIRRP biosolids stockpile is expected to exhibit sulfur concentrations at or below reporting limits and therefore preclude the need for comprehensive sulfur analysis (i.e., ASTM D5504).

### 3.2.4.2 Observations

BAAQMD staff accompanying the Jacobs sampling team indicated that strong odors had been observed from the NIRRP Stormwater Ponds two weeks prior to the week of sampling. At BAAQMD's request, an additional sample was therefore collected from this location.

### 3.2.4.3 Laboratory Analytical Results

Laboratory analytical results are presented in the following tables and figures. The laboratory reports are included in Appendix B.

#### 3.2.4.3.1 General Odor Analysis (ASTM E769-04) Results

Odor panel analysis results are summarized in Table 3-36 for ZWED, RWF, and NIRRP. The NIRRP compost piles exhibited the highest odor concentration. In addition, the most offensive source (most negative HT) was the Stormwater Pond.

**Table 3-36. Odor Panel Analysis Results for Sampling Event 4**

Sample Description	DT	RT	I	HT	DR	Comments
Lagoons (RWF)	85	50	2.5	-0.4	---	
Compost Piles (NIRRP)	26,000	14,000	---	-0.6	---	RT>10,000. Sample observed at 50% dilution for Characterization. Sample not observed for Intensity.
Biosolids Stockpile (NIRRP)	240	140	3.7	-0.0	---	
CASP Contact Water Pond (NIRRP)	340	190	3.8	-1.1	---	

Notes:

DR = dilution ratio; I = intensity; RT = recognition to threshold

Figure 3-53 through Figure 3-56 are odor descriptor graphics showing the average sensation of the odor descriptors (on a scale 1 to 10). General findings are as follows:

- The RWF lagoon source exhibited weak odor intensity with slight decay odors.
- The NIRRP compost pile exhibited relatively high odors primarily characterized as herbal.
- The NIRRP biosolids stockpile exhibited mild odor intensities characterized as decay, herbal, and wood (herbal and wood are generally considered less offensive).
- The NIRRP CASP contact water pond exhibited moderate odors including a combination of decay (i.e., sulfur/fecal) and earthy.

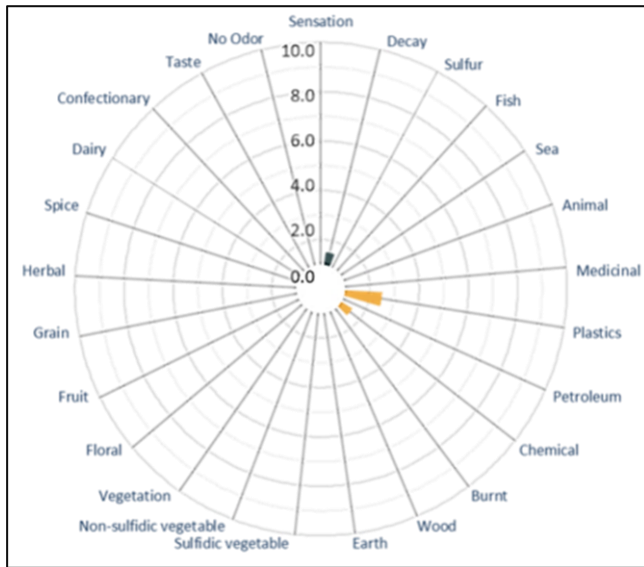

Figure 3-56. Odor Descriptors for Lagoons

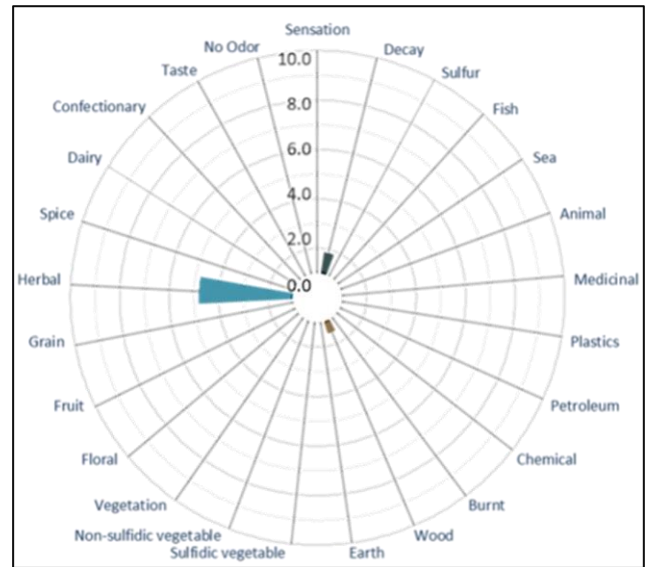

Figure 3-56. Odor Descriptors for Compost Piles

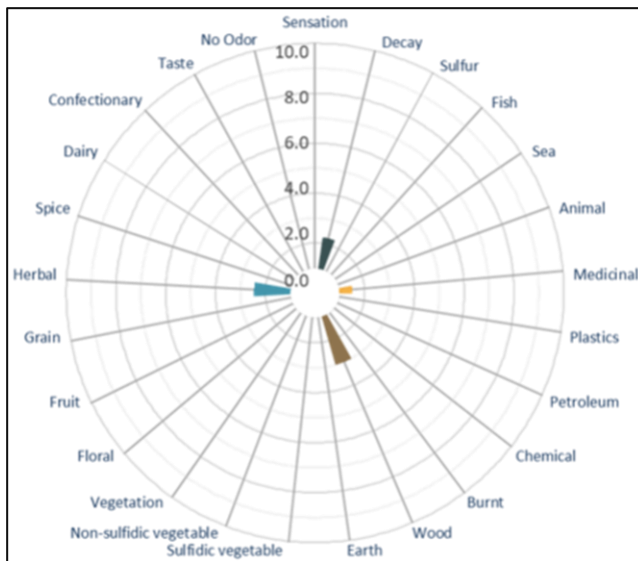

Figure 3-56. Odor Descriptors for Biosolids Stockpile

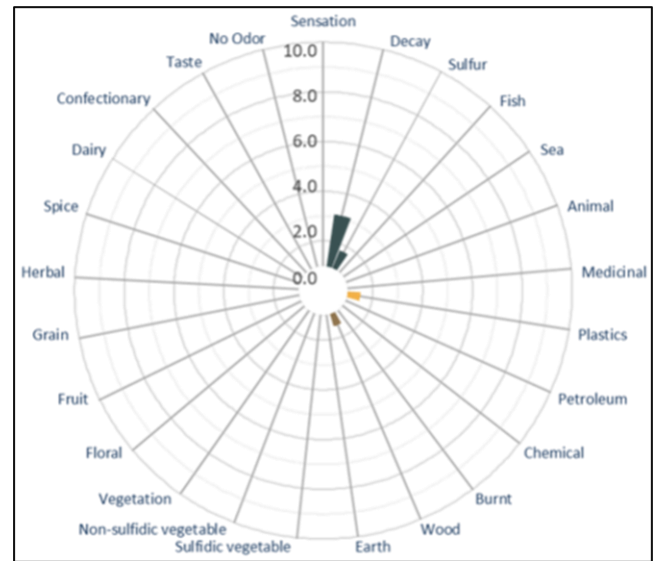

Figure 3-56. Odor Descriptors for CASP Contact Water Pond

### 3.2.4.4 Odor Profile Method Results

#### 3.2.4.4.1 OPM Intensity Results

OPM Intensity results are summarized in Table 3-37. Key findings are as follows:

- NIRRP compost piles exhibited relatively high odor intensities characterized as pine with some fecal, rotten fruit (organic reduced sulfur compounds), and musty.
- Both the RWF lagoons and the upwind sample exhibited weak odor intensities with some fecal and rancid, respectively. The upwind rancid may be attributed to the Bay, where organic decay can result in rancid odors.

- The NIRRP CASP Contact Water Pond exhibited moderate odor intensities characterized as musty and some rotten vegetable.

**Table 3-37. OPM Odor Characterization Results for Sampling Event 4**

Location	Odor Characteristics and Intensities
NIRRP Compost Pile	pine 5.0±2.6; odor note: fecal, rotten fruit, musty
RWF Lagoons	musty 2.0±1.6; odor note: fecal
Upwind/ Bay	musty 1.0±1.2; odor note: rancid
NIRRP CASP Contact Water Pond	fecal 3.0±2.0, musty 1.5±1.9, rotten vegetable 1.5±1.9; odor note: medicinal

### 3.2.4.4.2 Persistency Curves

Figures 3-57 through 3-60 provide persistency curves for the various sources sampled during Sampling Event 4. The key findings from the persistency curves are as follows:

- The NIRRP compost pile source exhibited primarily pine with some rancid and musty. While the pine intensity is relatively high, this odor type is considered less offensive.
- The RWF lagoons exhibited primarily musty at relatively low intensities.
- The upwind sample exhibited musty at low intensity levels.
- The NIRRP CASP Contact Water Pond exhibited fecal, rotten vegetable, and musty. This source was septic, and this likely lead to it exhibiting fecal and rotten vegetable odorants.



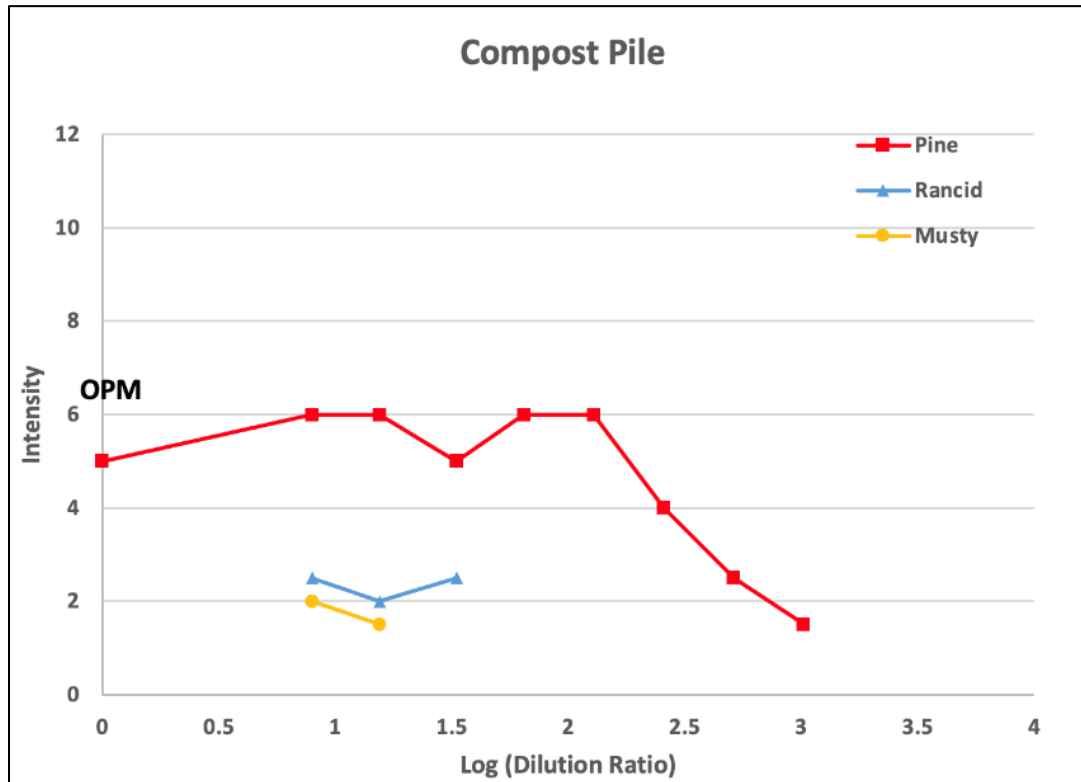

Figure 3-57. NIRRP Compost Pile OPM Persistency Curves

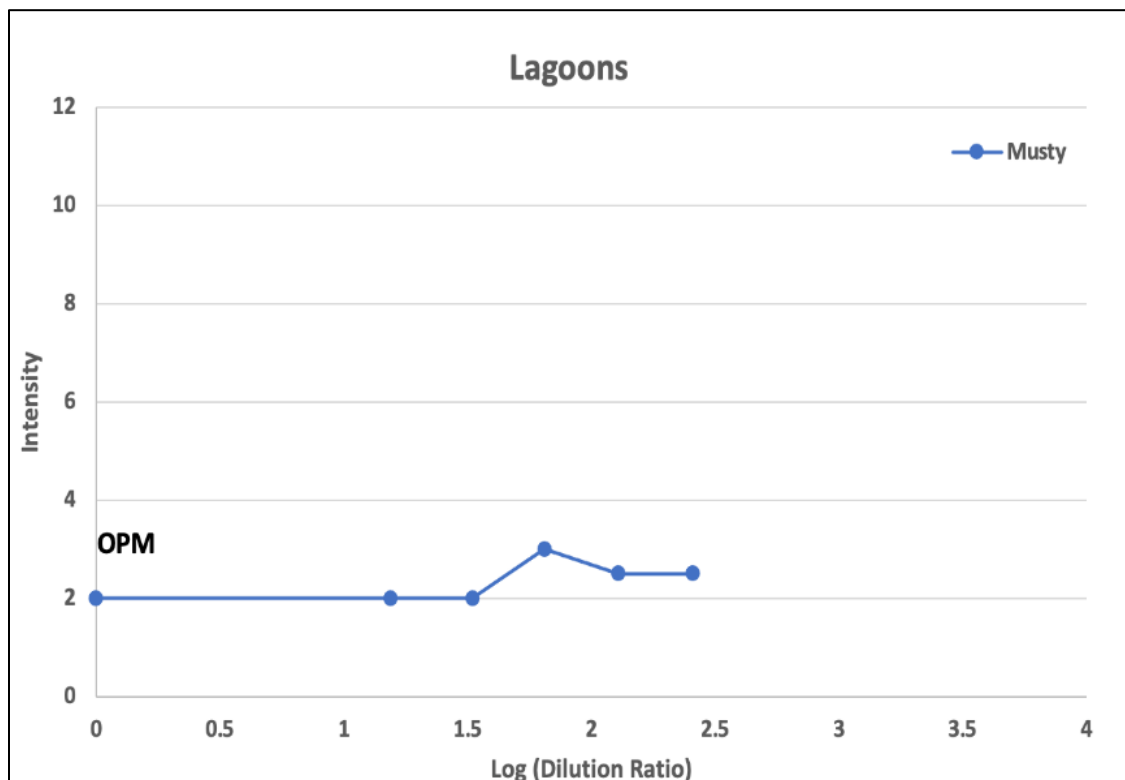

Figure 3-58. RWF Lagoons OPM Persistency Curves

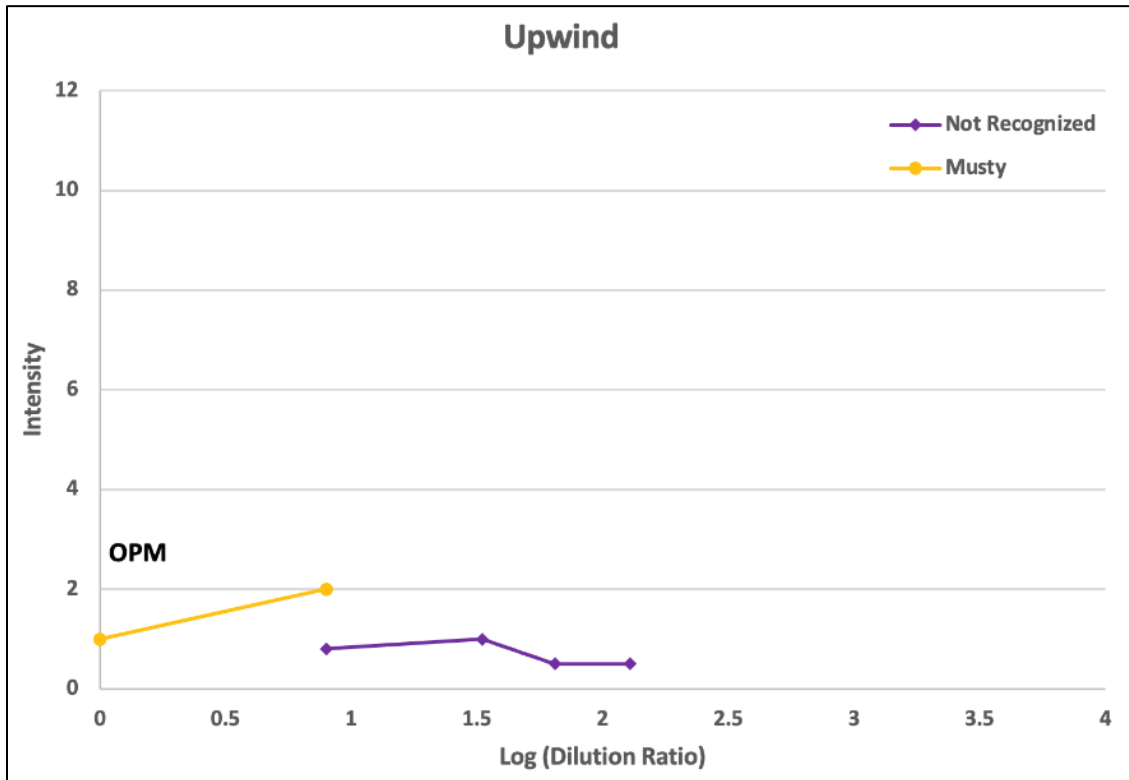

Figure 3-59. Upwind/Bay OPM Persistency Curves

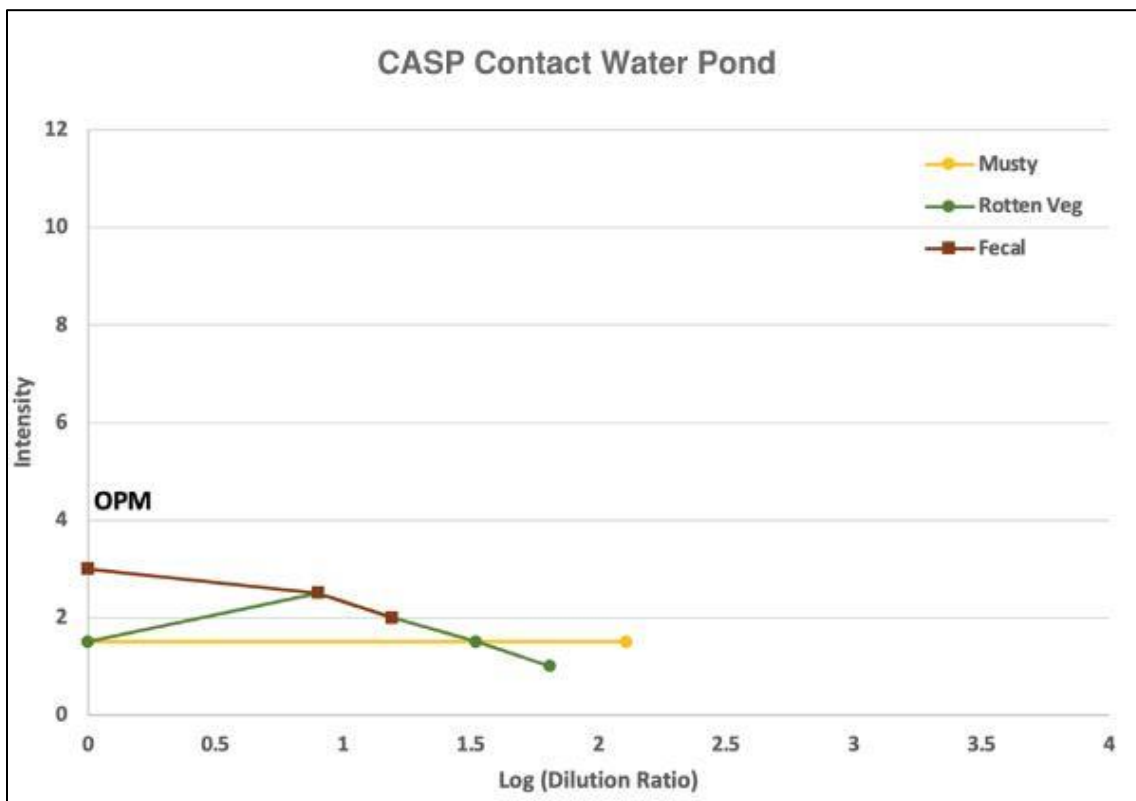

Figure 3-60. NIRRP Stormwater Pond OPM Persistency Curves

### 3.3 Summary of Sampling Events Conducted by Others

Jacobs coordinated the Study sampling activities with two other studies being conducted in parallel with this Study: the mobile, real-time odor sampling and tracing activities conducted by Montrose on behalf of BAAQMD and a community impact study conducted by Jacobs on behalf of the City of Milpitas. The following sections present summaries of these two studies' sampling events where relevant to this Study.

#### 3.3.1 City of Milpitas Community Impact Study

A community odor study was undertaken by the City of Milpitas to gather data about the sources of the odors impacting the community and to determine how these odors affect the City's residents. The findings of the community impact study were shared by the City of Milpitas with BAAQMD to obtain an enhanced understanding of the odor emissions that directly impact the communities. The City of Milpitas does not have jurisdiction over most of the odor emitting sites but is a key stakeholder as its community has been adversely affected by fugitive odors in the area due to its position southeast and generally downwind of key odor sources.

Trained City of Milpitas staff conducted field odor assessments using field olfactometers (Scentroid SM100) and a portable weather station to measure the odor strength in D/T and describe the odors observed (character, intensity, and HT) under the wind conditions. A total of 50 field odor assessments were undertaken at 11 discrete locations in the City of Milpitas by multiple field assessors between November 2019 and July 2021. On average, two field assessments were undertaken every three weeks on random days of the week and a random time of the day, resulting in a total of 580 field observations.

The Milpitas community impact study determined the frequency of odors present, the odor intensity, the odor strength (D/T) and the HT of the odors observed at the discrete locations in the community during the field assessments. The odor strength at the discrete locations inside the community were typically faint (D/T around 5) and unpleasant, which may lead to nuisance and complaints depending on the sensitivity of the locality and nature of the odor (i.e., frequency, duration, and offensiveness). The odor strength was occasionally distinct (D/T greater than 10) and revolting at Milmont Drive, Tramway Drive, and Marylinn Drive, which makes the likelihood of odor nuisance and complaints highly likely (refer to and Table 3-41).

Noticeable odors were consistently observed directly downwind of NIRRP, RWF, ZWED, and the Main Lift Station. These odors were always strong and often extremely strong. The odor strength downwind of the odor emitting facilities was on average greater than 50 D/T and described as "revolting," which makes the likelihood of odor nuisance and complaints almost certain in these locations.

##### 3.3.1.1 Frequency of Odors Observed

Table 3-38 shows the frequency of odors observed at the 11 assessment locations, which include the locations downwind of the primary odor-emitting facilities where noticeable odors were consistently observed. Odors were observed frequently within the community with most frequent observation at Milmont Drive (50 percent of all field assessments) and least frequent at Mt Shasta Avenue (9 percent of all field assessments).

**Table 3-38. Results Field Odor Assessments Frequency of Odors Observed**

Survey Location	Odor Present (% of the time) <sup>a</sup>
Downwind NIRRP	100
Downwind ZWED	100
Downwind RWF	98

Survey Location	Odor Present (% of the time) <sup>a</sup>
Downwind Lift Station	98
Milmont Drive	50
Tramway Drive	50
Marylinn Drive	30
Alvarez Court	25
Murphy Ranch Road	20
Los Coches Street	16
Mt Shasta Avenue	9
Wilson Way	5

<sup>a</sup> The percentage of the 50 field odor assessments in which odors were observed by at least 1 assessor.

A discrete location at the northern city boundary (Wilson Way) was also assessed between December 21, 2020, and July 30, 2021. Nineteen surveys were undertaken during that period and odors were observed only one time and were characterized as unpleasant but weak.

Odors were observed during each season and no significant differences were observed between the odor strength and odor character emitted in the winter-spring 2019/2020 period (before COVID-19 restrictions) and in the winter-spring 2020/2021 period (during COVID-19 restrictions).

### 3.3.1.2 Odor Intensity

When odors were observed at the different survey locations, the odor intensity varied from being very weak to extremely strong (Table 3-39). Directly downwind of the key odor-emitting facilities, strong odors were noticed consistently and were often extremely strong, with the ZWED downwind location consistently having the strongest odor intensity (average 5.8 on a scale of 0 to 6). The odor intensity at the discrete locations within the community was typically weak while occasionally strong at Milmont Drive and Murphy Ranch. As expected, wind speed and direction have direct influence on the measured intensity values, with locations directly downwind of odor emitting facilities exhibiting the greatest intensity values. As such, back trajectories are able to link odors to specific sources, as described further in this section.

**Table 3-39. Results of Field Odor Assessments -- Odor Intensity Observed during 50 Surveys**

Survey Location	Odor Intensity <sup>a</sup>			
	Average <sup>b</sup>		Maximum <sup>b</sup>	
Downwind NIRRP	3.8	Strong/Distinct	6	Extremely Strong
Downwind ZWED	5.8	Extremely Strong/Very Strong	6	Extremely Strong
Downwind RWF	4.1	Strong	6	Extremely Strong
Downwind Lift Station	3.0	Distinct	5	Very Strong
Wilson Way	2.2	Weak/Distinct	2	Weak
Milmont Drive	2.1	Weak	4	Strong
Tramway Drive	1.8	Weak/Very Weak	3	Distinct
Marylinn Drive	1.7	Weak/Very Weak	3	Distinct
Murphy Ranch Road	1.6	Weak/Very Weak	4	Strong
Mt Shasta Avenue	1.4	Very Weak/Weak	1	Very Weak

Alvarez Court	1.3	Very Weak/Weak	2	Weak
Los Coches Street	1.1	Very Weak	2	Weak

<sup>a</sup> Odor Intensity scale: Not Detectable (0), Very Weak (1), Weak (2), Distinct (3), Strong (4), Very Strong (5), Extremely Strong (6)

<sup>b</sup> Fifty field odor assessments undertaken between October 31, 2019 and July 30, 2021. This equals an average odor assessment frequency of two assessments every three weeks, except for the initial months of the global COVID-19 pandemic (middle of March 2020 until the end of June 2020) when no assessments were undertaken. Wilson Bay was added later and assessed only between December 21, 2020, and July 30, 2021, with 19 surveys undertaken during that period.

### 3.3.1.3 Hedonic Tone

The (un)pleasantness of the odors (hedonic tone) varied greatly when odors were observed at the different survey locations but was never pleasant (Table 3-40). Directly downwind of the key odor-emitting facilities, HT was consistently unpleasant/revolting, with the ZWED downwind location consistently observed as the most unpleasant (average -2.7 on a scale from -3 to 1). The odor intensity at the discrete locations inside the community was typically unpleasant while occasionally revolting at Milmont Drive.

**Table 3-40. Results of Field Odor Assessments - Hedonic Tone of Odors Observed**

Survey Location	Hedonic Tone <sup>a</sup>			
	Average <sup>b</sup>		Maximum <sup>b</sup>	
Downwind ZWED	-2.7	Nauseating/Revolting	-3	Nauseating
Downwind NIRRP	-1.7	Revolting/Unpleasant	-3	Nauseating
Downwind RWF	-1.7	Revolting/Unpleasant	-3	Nauseating
Downwind Lift Station	-1.2	Unpleasant/Revolting	-2	Revolting
Milmont Drive	-1.1	Unpleasant	-2	Revolting
Tramway Drive	-1.0	Unpleasant	-1	Unpleasant
Marylenn Drive	-1.0	Unpleasant	-1	Unpleasant
Los Coches Street	-1.0	Unpleasant	-1	Unpleasant
Wilson Way	-1.0	Unpleasant	-1	Unpleasant
Murphy Ranch Road	-0.8	Unpleasant/Neutral	-1	Unpleasant
Alvarez Court	-0.7	Unpleasant/Neutral	-1	Unpleasant
Murphy Ranch Road	-0.8	Unpleasant/Neutral	-1	Unpleasant
Los Coches Street	-1.0	Unpleasant	-1	Unpleasant
Mt Shasta Avenue	-0.3	Neutral/Unpleasant	-1	Unpleasant
Wilson Way	-1.0	Unpleasant	-1	Unpleasant

<sup>a</sup> Hedonic Tone scale: Pleasant (1), Neutral (0), unpleasant (-1), revolting (-2), nauseating (-3)

<sup>b</sup> Fifty field odor assessments undertaken between October 31, 2019, and July 30, 2021. This equals an average odor assessment frequency of two assessments every three weeks, except for the initial months of the global COVID-19 pandemic (middle of March 2020 until the end of June 2020) when no assessments were undertaken. Wilson Bay was added later and assessed only between December 21, 2020, and July 30, 2021, with 19 surveys undertaken during that period.

### 3.3.1.4 Odor Strength (D/T)

When odors were observed at the different survey locations, the odor strength (D/T) varied from weak to distinct (Table 3-41). Directly downwind of the key odor-emitting facilities, distinct odors were consistently observed

with average values greater than 50 for the three largest facilities (NIRRP, ZWED, and RWF). The odor strength at all discrete locations within the community were faint (D/T around 5) while usually distinct (D/T greater than 10) at Milmont Drive, Tramway Drive, and Marylinn Drive. This was consistent with the measured odor intensity at the locations.

**Table 3-41. Results Field Odor Assessments - Odor Strength of Odors Observed**

Survey Location	Odor Strength <sup>a</sup>	
	Average <sup>b</sup>	Maximum <sup>b</sup>
Downwind ZWED	936	2260
Downwind NIRRP	68	720
Downwind RWF	57	411
Downwind Lift Station	27	259
Milmont Drive	7	39
Tramway Drive	6	28
Marylinn Drive	7	20
Tramway Drive	6	28
Alvarez Court	4	11
Murphy Ranch Road	3	6
Los Coches Street	3	8
Mt Shasta Avenue	3	5
Wilson Way	< 2	< 2

<sup>a</sup> The odor strength in D/T as measured with the SM100 field olfactometer.

<sup>b</sup> Fifty field odor assessments undertaken between October 31, 2019, and July 30, 2021. This equals an average odor assessment frequency of two assessments every three weeks, except for the initial months of the global COVID-19 pandemic (middle of March 2020 until the end of June 2020) when no assessments were undertaken. Wilson Bay was added later and assessed only between December 21, 2020, and July 30, 2021 with 19 surveys undertaken during that period.

### 3.3.1.5 Odor Character Downwind of Facilities

The odor character as observed directly downwind of the main odor-emitting facilities has been described by different field assessors independently a total of 50 times at different times of the days and different days of the week throughout the study. In more than 75 percent of these assessments, the odor character downwind of the RWF and Lift Station was described as being either Sewage, Septic, Fecal or Urine. These odor descriptors can be considered unique for the RWF and Lift Station as they were not used when describing the odor downwind of NIRRP and rarely used when describing the odor downwind of the ZWED facility (Figure 3-61).

Similarly, in nearly 70 percent of these assessments, the odor character downwind of the NIRRP facility was described as being either Garbage, Sweet, or Rotten Vegetables. These odor descriptors are also unique for the NIRRP facility as they were not used when describing the odor downwind of the RWF and Lift Station and only Rotten Vegetables was used when describing the odor downwind of the ZWED facility (Figure 3-61).

Also, in nearly 70 percent of these assessments, the odor character downwind of the ZWED facility was described as being either Putrid, Rancid, Manure, Pungent, or Rotten Vegetables. These odor descriptors are unique for the ZWED facility as they were rarely used when describing the odor downwind of the RWF and Lift Station or the NIRRP facility (Figure 3-61).

In summary, the odor character downwind of the three main odor-emitting facilities are relatively unique and were mostly described as follows:

- RWF: Sewage, Septic, Fecal, or Urine
- NIRRP facility: Garbage, Sweet, or Rotten Vegetables
- ZWED facility: Rancid, Putrid, Manure, Rotten Vegetables, or Pungent

These relatively unique odor descriptors may be used when assessing the origin of the odors that are experienced in the community.

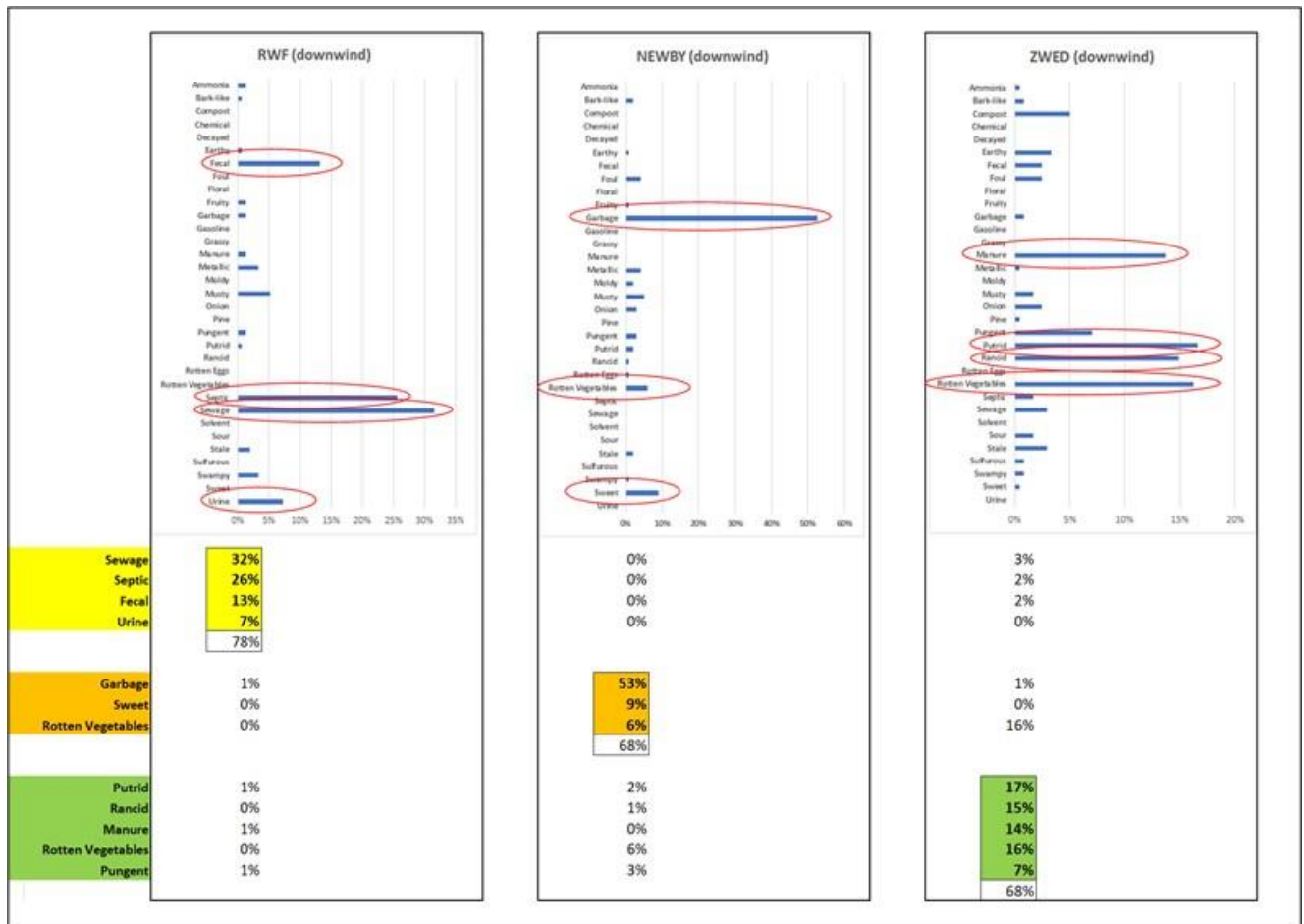

Figure 3-61. Frequency and Descriptors of Odor Observed Directly Downwind of Main Odor-Emitting Facilities (Milpitas Community Impact Study)

### 3.3.1.6 Odor Character in the Community

The relatively unique odor descriptors used to describe the odors emitted from the three main facilities can be used to provide a global estimation of the origin of the odor experienced in the community. This estimation has been illustrated using a binary large object (BLOB) map. A BLOB map is a visual representation of a vague amount of grouped data that lacks definite shape. BLOB is a block of data stored in a database that cannot read the BLOB's structure and only references it by its size and location. Figure 3-62 illustrates the BLOB map that depicts the estimated source of odor emissions pertaining to the odors observed in the community. The size of the circles is directly related to the measured intensity values (refer to Table 3-39), with larger circles pertaining to locations closer to odor emitting facilities. The small triangles reflect odor complaint locations from the last

five years. Data integrated into the BLOB map includes all data collected as part of this study as well as City of Milpitas study data.

All three main odor-emitting facilities contribute to odors frequently observed in the community. Although the odors emitted from ZWED are by far the most intense and the most unpleasant, their reach is mostly limited to only the first locations west and southwest in the community in the City of Milpitas (Figure 3-62). Odors emitted from the NIRRP facility contribute to a large extent to the odors observed at most of the discrete survey locations, while odors emitted from the RWF contribute to a lesser extent at most of the discrete survey locations and more to the further away location in the east and southeast of the community (Mt Shasta Avenue). Although this BLOB map is only a high-level visual representation, it can be used as a fairly accurate indication of where impacted odors originate from. This is because the observations have been made over a long period of time (21 months) on multiple individual field assessments (in total 50 assessment on random days of the week and random times of the day) by several assessors that showed to have a representative sensitivity for smell.

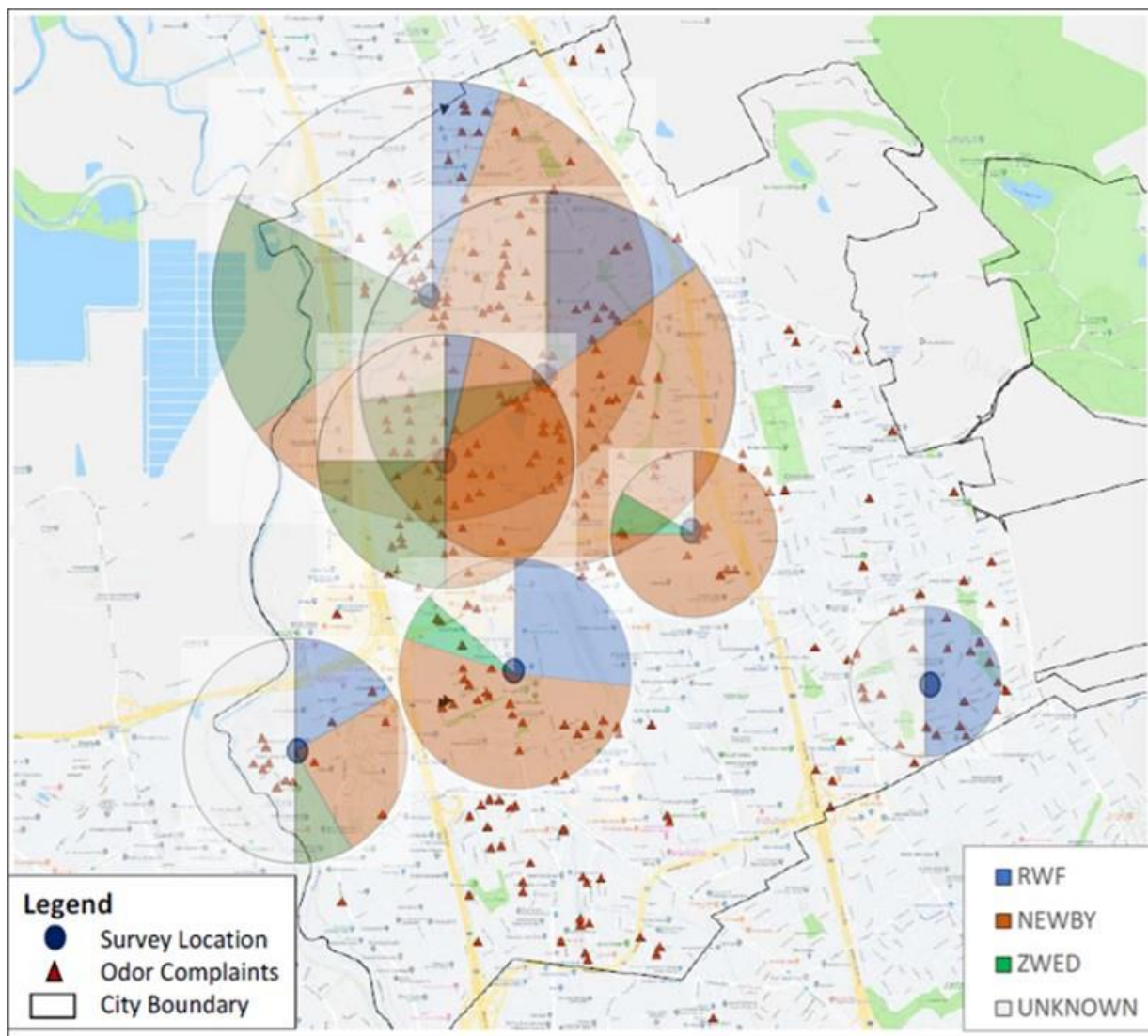

Figure 3-62. Visual Representation of Most Likely Origination of Odors Observed in the Community (Milpitas Community Impact Study)



The unique meteorological conditions in the area cannot be overstated. Terrain conditions can result in localized wind dynamics. Furthermore, San Jose often exhibits inversion layers that can trap pollutants and limit vertical mixing (Morgan, 1977). Under these conditions, the distance the odors can travel can be exacerbated and may be the reason for the long-distance impacts indicated on Figure 3-62. This could be the cause for odors from the RWF being observed farthest away in the southeast corner of the community.

It should be noted that the sewer collection system was not included in the scope of this study. Sewers can, depending on the age of the sewage, exhibit similar odor characteristics to those identified at the RWF. Therefore, the RWF odor findings shown on Figure 3-62 as far from the source could be, to some extent, attributed to a leaky odorous sewer collection system (i.e., one that exhibits positive pressure). That being said, based on extensive experience in collection system odor studies, odor impacts from leaky sewers are generally limited in the area of impact due to the small pick-hole openings in the manhole lids (i.e., small plume).

### **3.3.2 Montrose PTR-MS “Fingerprinting” Study**

This section provides discussion of the Montrose work and how the Montrose work product and the Jacobs work product complement each other for the purpose of meeting the Study’s goals and objectives. It should be noted that there is a distinguishing difference between the Jacobs and Montrose efforts, namely that Jacobs’ efforts focused on odor characterization and quantification while Montrose’s efforts focused on collective chemical compound identification to generate “chemical fingerprints” of the odors emitted from the dominant odor sources and then the collection of plumes in the community for a multivariate analysis of the community plumes to the fence line fingerprints to determine odor allocation.

Correlations are determined from the principal component analysis (PCA) of unique compounds identified at the fence line of facilities and ratios of compounds also found within the fence line fingerprint. The community plumes are then compared mathematically and statistically to determine correlations to a particular facility or overlap of plumes from multiple facilities.

#### **3.3.2.1 Montrose Mobile Platform Description**

The following elements are included in the Montrose mobile platform:

- Ionicon PTR-Time of Flight (TOF)-MS 6000x3 real time analyzer
- Agilent 5890 GC integrated to PTR-TOF-MS for EPA Method 18 Reference Method Data
- MKS 2030D and Optically Enhanced Starboost MKS Fourier transfer infrared spectrometer for single digit parts per billion (ppb) formaldehyde
- Durag-AP2E Tunable Diode Laser Proceas real time single digit ppb H<sub>2</sub>S analyzer
- Computerized Environics NIST traceable gas dilution system (1000:1) dilution
- Teledyne Zero Air Generator with Act. Charcoal Scrubber
- Integrated sampling system
- Computerized geographic positioning system (GPS)/Meteorological Station (sonic 3D anemometer and digital direction) / Video capture system
- Integrated generator and voltage line cleaners with uninterruptable power supply
- Heated sampling line with heated probe and filtration system (100 feet) plus Snorkel

PTR-MS technology uses gas phase hydronium reagent ions that are produced in an ion source. A PTR-MS instrument consists of an ion source that is directly connected to a drift tube and an analyzing system (TOF mass spectrometer). Figure 3-63 illustrates the key PTR-MS components.

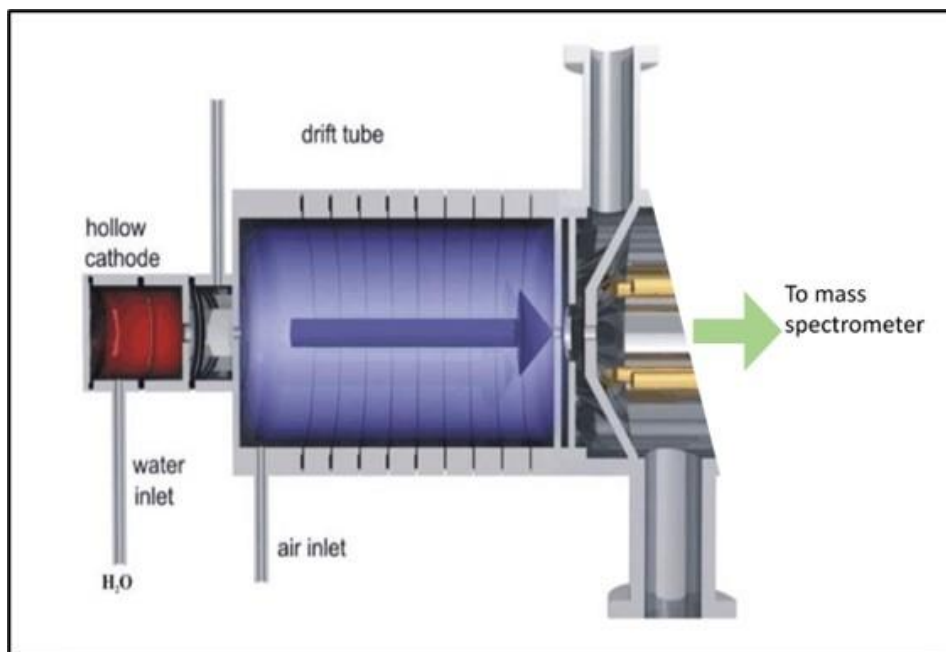

Figure 3-63. PTR-MS Illustration

Advantages of the Montrose mobile platform include:

- PTR-MS for real time chemical compound measurements
- Virtually any carbon containing compound in parts per trillion (ppt) range
- No compressed gases while in real time mode
- EPA Reference Method 18 compatibility with GC
- Weather Station and GPS
- Mobile GPS and Real Time Capability (1 data point per second)

### 3.3.2.2 Summary of Sample Events

The level of Montrose engagement varied for the various sample events. Each sample event in which Montrose participated is described in the following subsections.

As part of Sample Events 1, 2, and 3, Jacobs collected multiple bag samples at the three key facilities and shipped them overnight to Montrose for their analysis using PTR-MS. Table 3-42 lists the sources that were sampled and analyzed by Montrose to perform an initial scan to identify the wide range of individual compounds and specific markers of these odor sources.

Table 3-42. Summary of Bag Sampling in Support of Montrose Study

Event	Purpose of Sampling	Sample Locations
Sample Event 1	To enable Montrose to pre-calibrate their mobile platform with foreknowledge of individual compounds prior to the future sample event effort in which Montrose would use their mobile platform onsite	<ul style="list-style-type: none"> <li>▪ ZWED Interior Space (sample ID no. M102)</li> <li>▪ RWF Primary Clarifier Effluent Weir Collection Box (sample ID no. M201)</li> <li>▪ NIRRP Composting Piles (sample ID no. M301)</li> <li>▪ NIRRP Landfill working face (sample ID no. M302)</li> <li>▪ NIRRP Dried Biosolids (sample ID no. M303)</li> <li>▪ NIRRP MRF Ambient Inside (sample ID no. M402)</li> </ul>

Event	Purpose of Sampling	Sample Locations
Sample Event 2	To enable Montrose to validate previous findings and provide additional data sets	<ul style="list-style-type: none"> <li>▪ Upwind of key facilities (sample ID no. M-02)</li> <li>▪ RWF Primaries (sample ID no. M-03)</li> <li>▪ RWF Bioreactors (sample ID no. M-04)</li> <li>▪ ZWED Interior Space (sample ID no. M-01)</li> <li>▪ ZWED Biofilter (sample ID no. M-06)</li> <li>▪ NIRRP Landfill working face (sample ID no. M-05)</li> </ul>
Sample Event 3	To enable Montrose to validate previous findings and provide additional data sets	<ul style="list-style-type: none"> <li>▪ RWF East Primaries (sample ID no. 5-18 East Primaries)</li> <li>▪ RWF Bioreactors (sample ID no. 5-18 Bioreactor Aerobic)</li> <li>▪ RWF Bioreactors (sample ID no. 5-18 Bioreactor Mixing Zone)</li> <li>▪ RWF Lagoon (sample ID no. 5-18 Lagoon)</li> <li>▪ ZWED Interior Space (sample ID no. 5-17 ZWED Interior)</li> <li>▪ NIRRP Landfill Gas (sample ID no. 5-19 Landfill Gas)</li> <li>▪ NIRRP Landfill Working Face (sample ID no. 5-19 Landfill Working Face)</li> <li>▪ NIRRP Composting Pile (sample ID no. 5-19 NIRRP Composting Pile)</li> </ul>

For Sample Event 3, Montrose transported their mobile platform to the Study area for in-situ analysis. A brief description of Montrose’s activities follows:

- Montrose arrived on May 12, 2021, and began to set up and prepare their mobile platform for real-time monitoring. Montrose had a power supply failure that impacted their detection limits. However, even with the impacted higher detection limits, the limits of the PTR instrument still exhibited good accuracy (average 100 ppt level limits of detection (LODs)). These detection limits were considered appropriate for the required level of accuracy of the study and therefore Montrose was directed to continue monitoring efforts.
- It was decided that BAAQMD would send any automatic complaint notifications received to Montrose and the Jacobs field survey team for rapid response and measurements at the affected location. However, during the time that Montrose was in the vicinity using their mobile platform, no odors complaints were received.
- The following sources and areas were analyzed by Montrose’s mobile platform during Sample Event 3:
  - Control upwind
  - Estuary High Tide
  - Estuary Low Tide
  - ZWED, Along the fence line and downwind of biofilters/roll-up door
  - San José WRF, Continuous sensing of all primary and secondary tanks (e.g., aeration basins, secondary clarifiers, sludge lagoons, and drying beds)
  - Downwind of Recycling center next door to ZWED
  - NIRRP, including composting facility, landfill and MRF
  - Odor complaint address in Milpitas
  - Fremont town office park near border
  - Milpitas elementary school
  - Milpitas high school
  - Milpitas Hampton Inn parking lot (overnight continuous)

- Montrose experienced some difficulty with unsteady and unpredicted wind changes during portions of the sampling event. Early morning wind out of west and then reversal during afternoon to out of Milpitas. However, Montrose managed to measure different sources, but the triangulation was a challenge with the sub-optimal wind speed variability and vector changes.
- Montrose observed the following during Sample Event 3:
  - High odors at the NIRRP MRF on Monday May 17. However, the next day Montrose observed no unusual odors. It is speculated that possible septic cleaning was occurring on the day odors were observed. However, this was not confirmed by facility operations staff. Even so, odors subsided within a day and no strong odors were observed thereafter.
  - High odors in the southeast parking lot of ZWED. Odors were unique compared to the other odors noticed at ZWED. Follow-up discussion between Montrose, Jacobs and ZWED revealed that there are two fans that blow outward that serve the in-vessel composters (IVCs) located inside the facility. The IVCs dry all of the finished material before it gets shipped out to become compost. The day that the odor was observed, ZWED had all four IVCs operational. Unfortunately, the fans have to be on when the IVCs are used.
  - High odors were observed at an offsite location at an estuary culvert. Jacobs deployed an AcruLog unit and found several "hits."

### 3.3.2.3 Results of PTR-MS Analyses

Montrose PTR-MS results revealed unique individual compounds associated with specific facilities/sources. Figures 3-64 through 3-73 provide graphics that illustrate compound mass versus concentration. In all figures, the "x" axis represents m/z values, which is compound mass divided by charge. In most cases, the charge is essentially 1, thus the m/z value can be considered as mass, equal to molar mass (grams per mole) plus the molar mass of a hydrogen ion (essentially 1.0).

These results of the PTR-MS bag analyses by Montrose confirm the findings from the Milpitas community impact study indicating that the three main odor emitting facilities each have a relatively unique odor character.

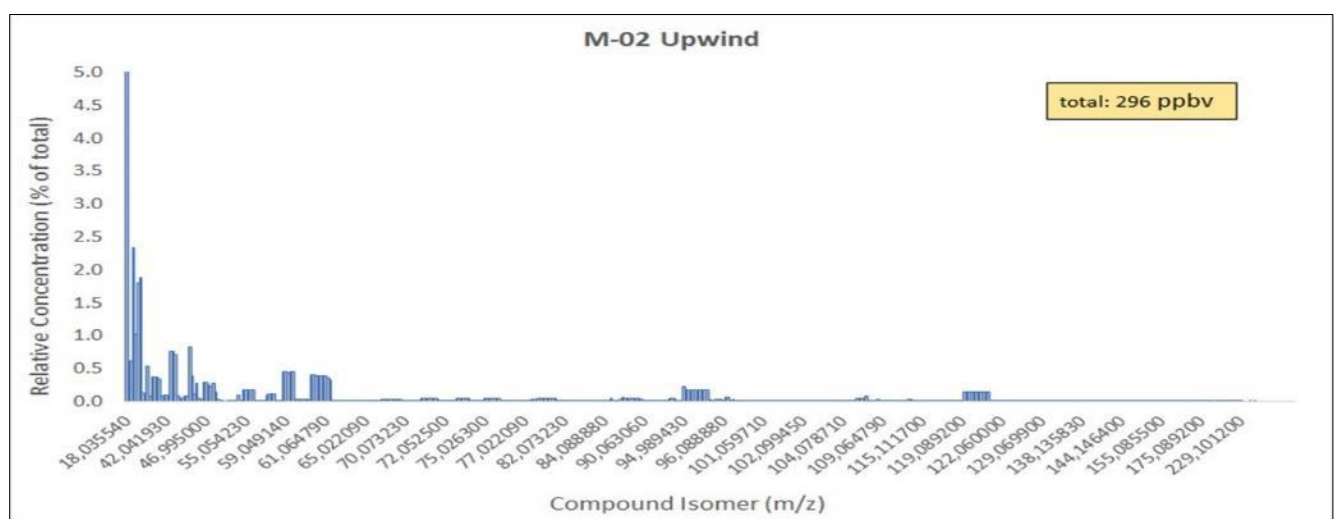

Figure 3-64. Chemical Fingerprint of the Air Upwind of the Main Odor-Emitting Facilities

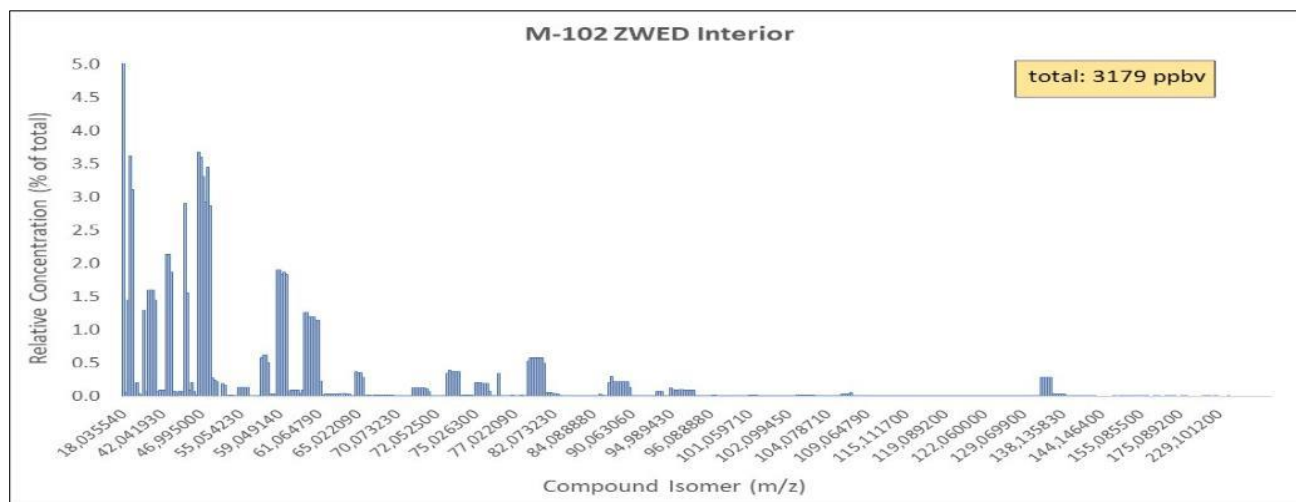

Figure 3-65. Chemical Fingerprint of the Air Inside the ZWED Facility

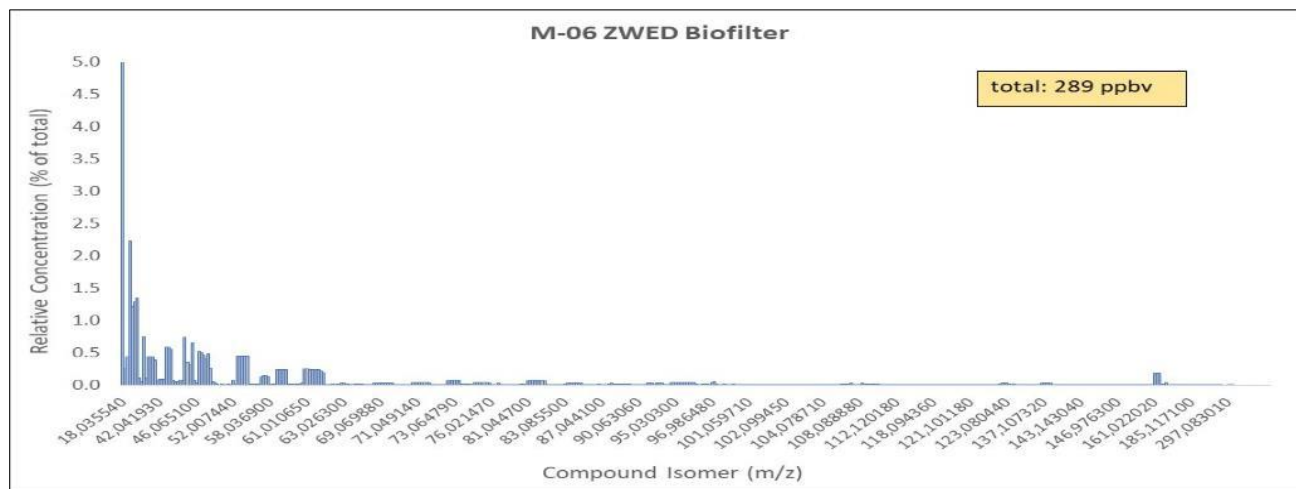

Figure 3-66. Chemical Fingerprint of the Air Emitted from a Biofilter at the ZWED Facility

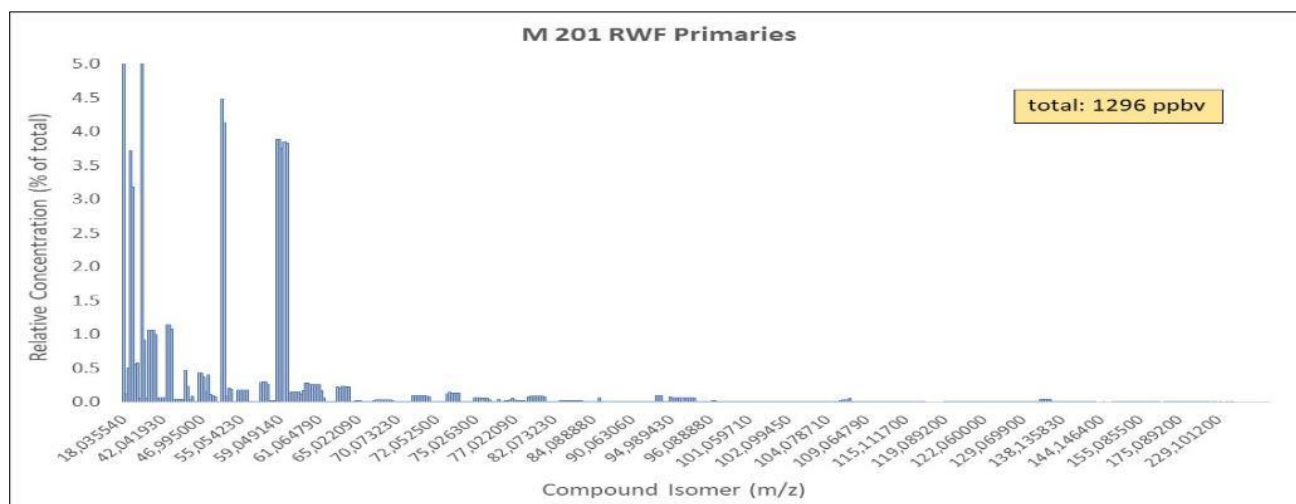

Figure 3-67. Chemical Fingerprint of the Air Emitted from a Primary Clarifier at the RWF Facility

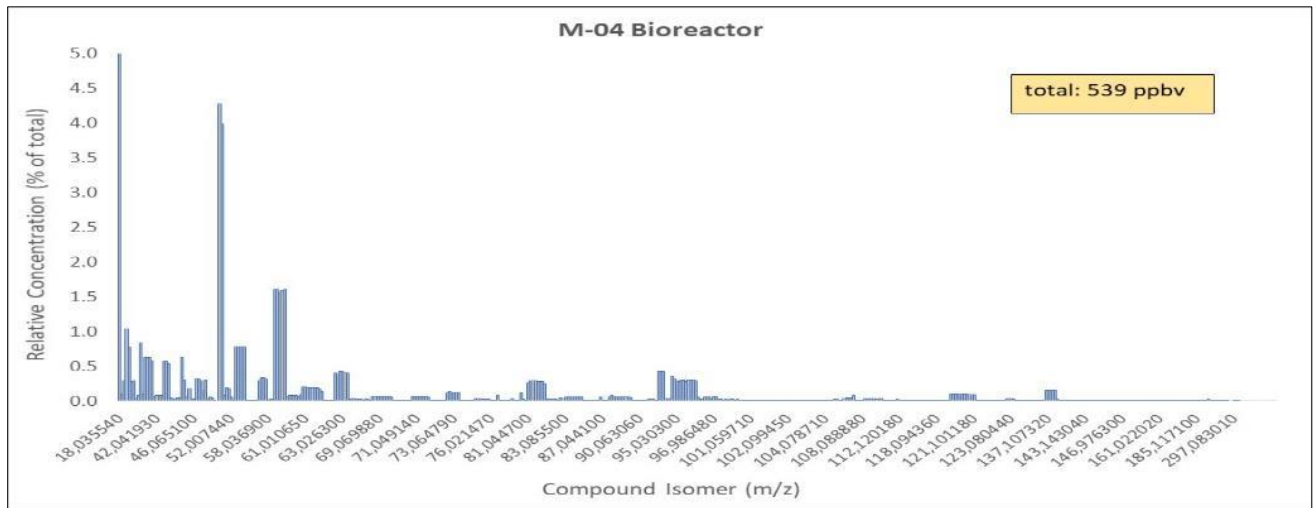

Figure 3-68. Chemical Fingerprint of the Air Emitted from a Bioreactor at the RWF Facility

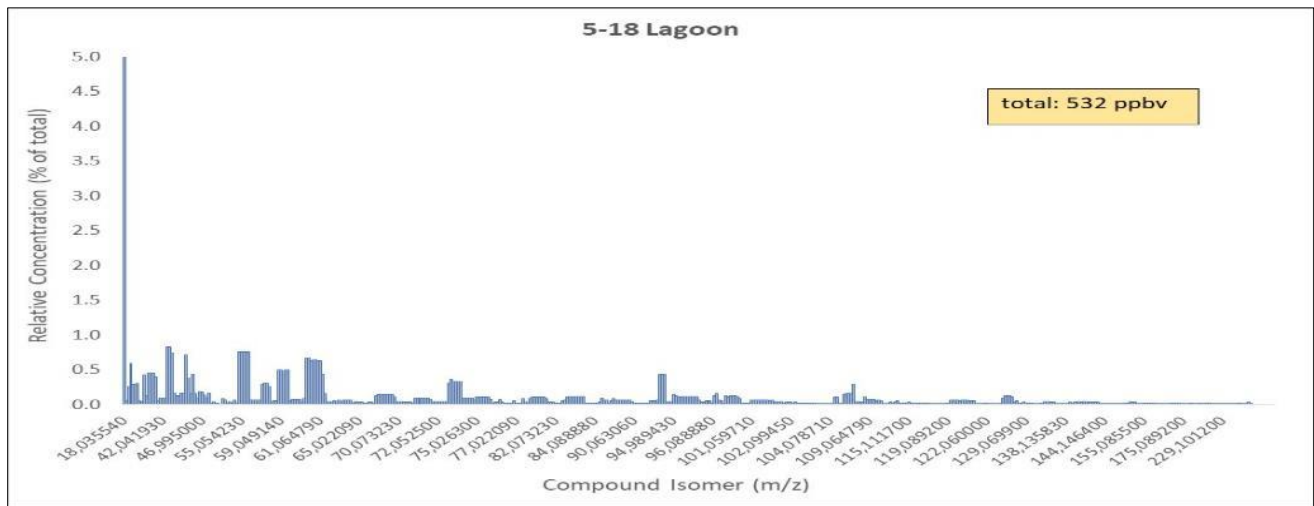

Figure 3-69. Chemical Fingerprint of the Air Downstream of the Lagoons at the RWF Facility

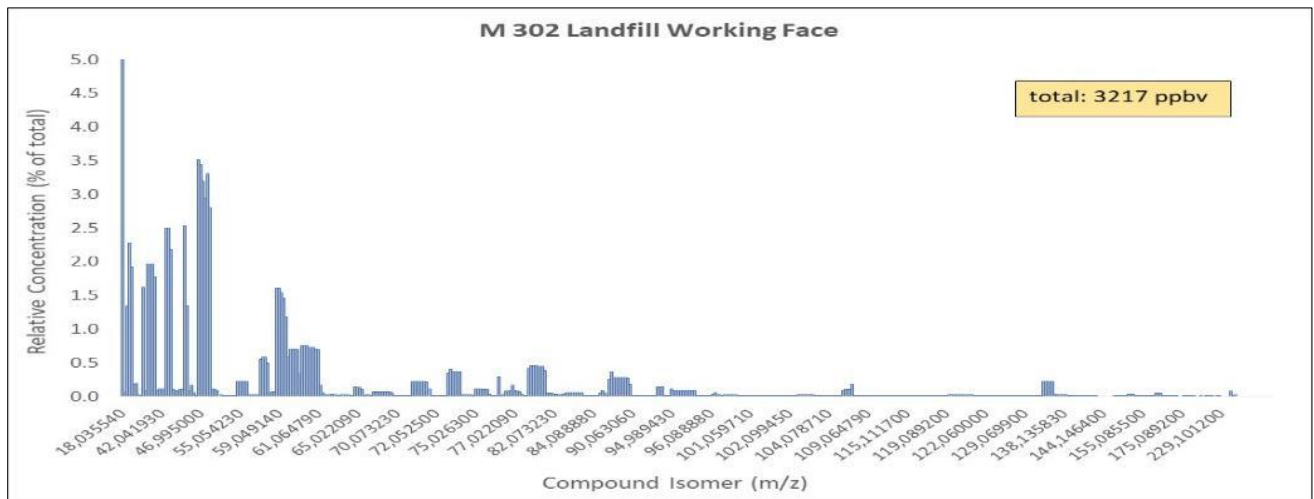

Figure 3-70. Chemical Fingerprint of the Air Downwind of the Landfill at the NIRRP Facility

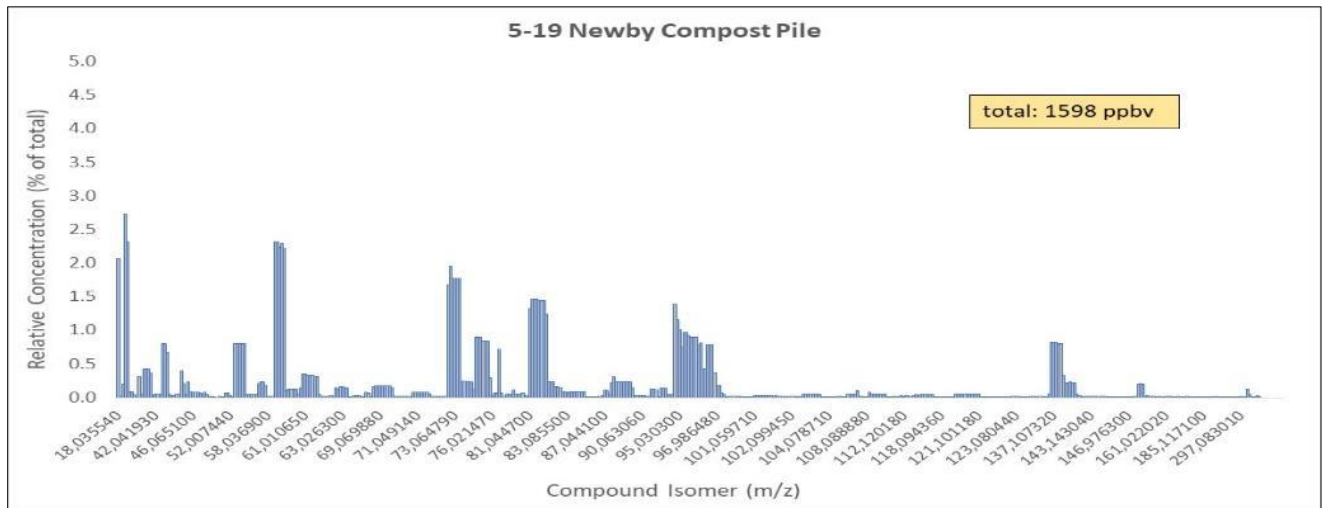

Figure 3-71. Chemical Fingerprint of the Air Emitted from a Compost Pile at the NIRRP Facility

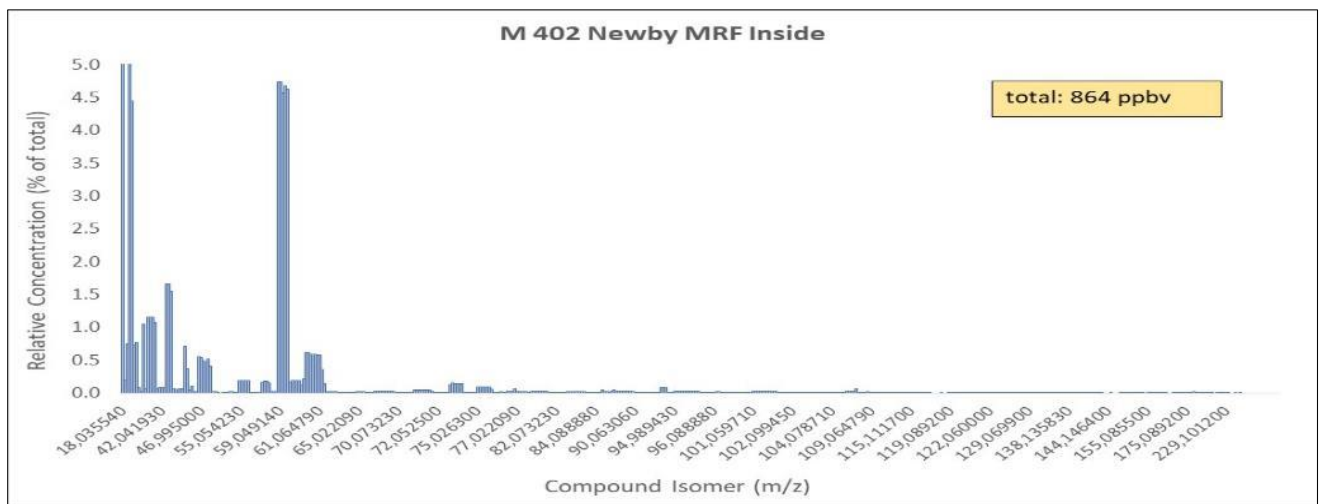

Figure 3-72. Chemical Fingerprint of the Air Inside the MRF at the NIRRP Facility

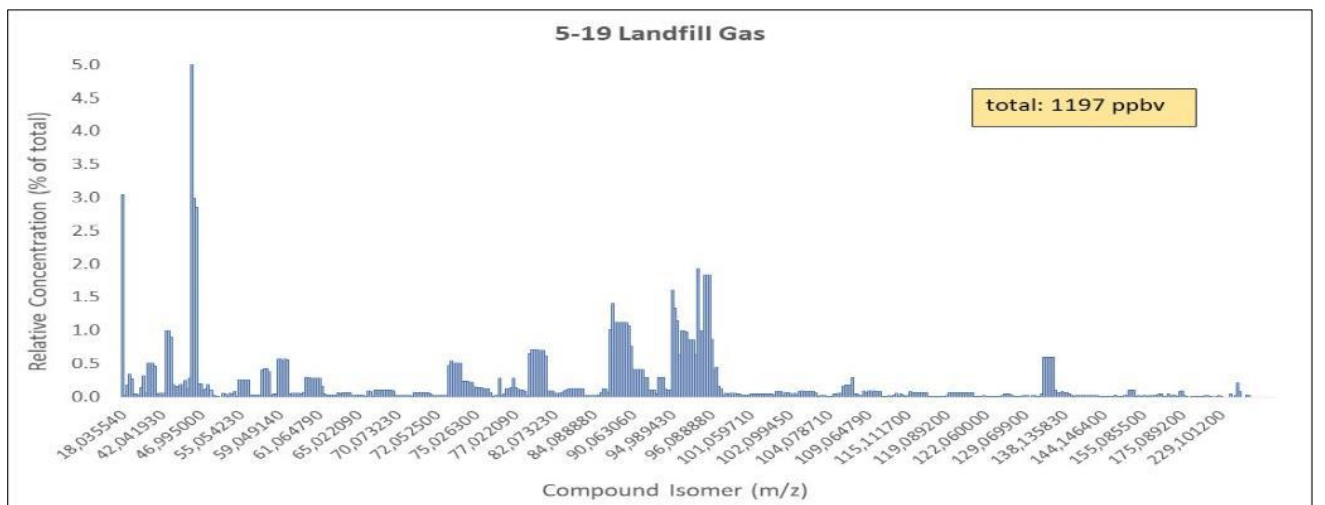

Figure 3-73. Chemical Fingerprint of the Landfill Gas at the NIRRP Facility

### 3.3.2.4 Results of Principal Component Analyses of the PTR-MS Data

PCA is used to reduce the dimensionality of large data sets by transforming a large set of variables into a smaller one that still contains most of the information in the large set. In essence, it correlates a group of compounds to all the possible compounds in a model. In this project, the multivariate analysis (MVA) PCA measures how variables, such as ratios or specific unique compounds in a group of compounds (plume) correlate to all of the possible compounds in a model (facility plume fingerprint). For more information on MVA PCA analysis, please refer to the paper by Wold et al. (1987).

PCA allows for fingerprinting each facility/source to generate a model to determine uniqueness. Then, plumes measured in the community can be compared to the model to provide correlation. Figure 3-74 provides PCA results for several bag samples correlating with different facilities/sources. Figure 3-75 provides a summary of multiple individual PCA analyses of bag samples. The results indicate that good differentiation exists between the sources and between bags, allowing for "fingerprinting" and correlation of offsite odors to facilities/sources.

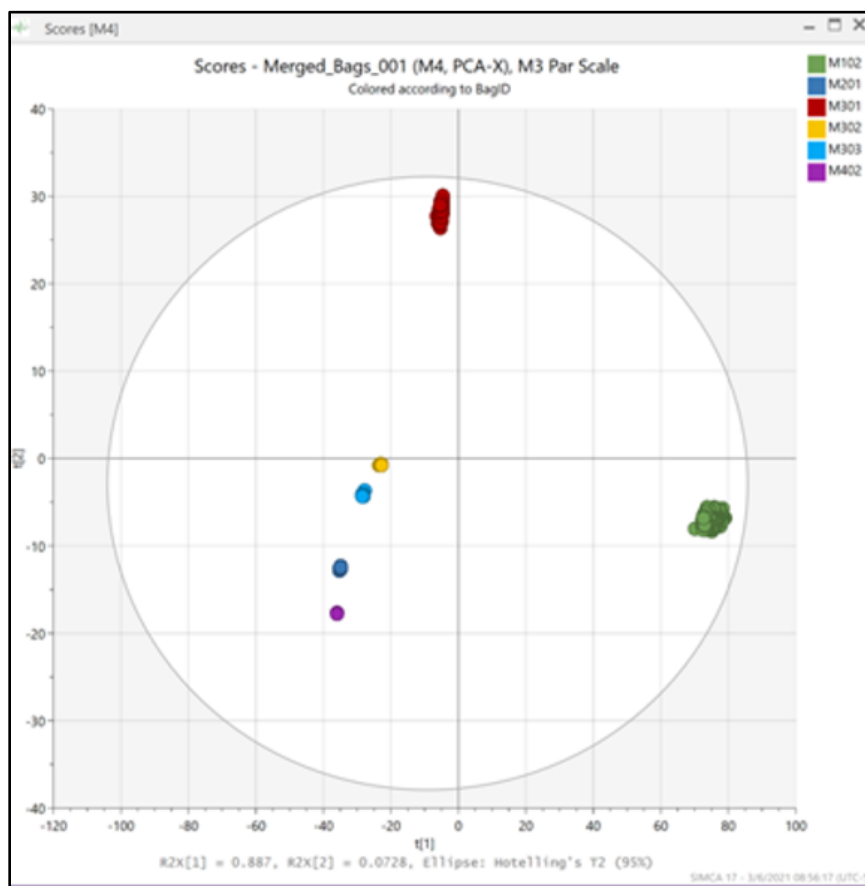

Figure 3-74. PCA Differentiation Between Bag Samples (Source: Montrose)

Note the following bag sample identification:

- M102 is ZWED Interior Space
- M201 is Primary Clarifier Effluent Weir Collection Box
- M301 is Composting Piles (ASP)
- M302 is Landfill Working Face (ZWED residuals)
- M303 is Dried Biosolids
- M402 is MRF Interior





Figure 3-75. Comparison of PCA Results of Multiple Bags

Key findings from the Montrose efforts include:

- Unique “chemical fingerprint” distinct to each key odor source were found and confirmed via PCA.
- Unique “facility fingerprint” detected by PTR-MS agreed with Jacobs odor characterization and quantification results.
- This study confirms that odorous air samples taken in the nearby community and analyzed by PTR-MS and PCA modeling can be a valid technique to identify which facility (or which facilities) the odors are originating from.

### 3.4 Odor Sampling Program Summary and Conclusions

#### General Findings

- The four sample events were conducted in compliance with BAAQMD standards, protocols, and recommendations as well as industry and national standards (i.e., EPA), making results defensible and reliable.
- Odor characterization from the four sample events revealed the following key “fingerprint” odorant groupings associated with key facilities:
  - San José RWF: Mostly sulfur (H<sub>2</sub>S and methyl mercaptan) and fecal.
  - ZWED: Sweet (aldehydes) and rancid (VFAs) with musty.
  - NIRRP: Rancid (VFAs) and sweet (aldehydes) with garbage. Landfill gas mostly sulfur (H<sub>2</sub>S) and fecal.
- OPM persistency curves reveal which odors persist as a function of dilution (i.e., distance away from the source). This is critical to understanding how odor characteristics from a single source can change as the plume passes into the community downwind. This is called the “peeling the onion” effect.
- Field olfactometry survey efforts were able to determine how each facility impacts downwind regions, with some areas impacted by multiple combined plumes where other areas are believed to be exclusively impacted by a single facility plume, depending on wind conditions.
- The results of this Study generally agree well with the results of the Milpitas community impact study and Montrose fingerprinting study.

- All three key odor-emitting facilities contribute to odors frequently observed in the community.
- Montrose findings revealed good differentiation between key facilities in terms of individual compound fingerprints.

### Sample Event Findings

- Each sample event provided clear findings that further informed the planning for subsequent events. This approach enabled optimization and refining of each sample event and built on the results of the previous sample events, as designed.
- The results of laboratory analytical work, field survey work, and UCLA (OPM) laboratory work generally agreed for each of the four sampling events. Each event provided confirmation of previous “fingerprint” odorants pertaining to specific sources.
- Rancid, sweet, sulfur, fecal, and musty were identified as sensorial relevant odorant groups during each sample event, as identified by analytical test results, Montrose test results, field survey results, and the associated UCLA persistency curves.
- Key sources of concern identified included:
  - ZWED Interior Space
  - ZWED Biofilter
  - RWF Primaries
  - RWF Bioreactors
  - NIRRP Working Face
  - NIRRP Landfill Gas
  - NIRRP Raw Compost Pile (fresh grinded material – before rows with biolayer)
- Sources that may require further evaluation include the following:
  - NIRRP Flares may have exhibited some residual odors with 99 percent thermal oxidation.
  - ZWED odor leaks on roof.
- Key findings from the Milpitas community impact study are summarized as follows:
  - All three key odor-emitting facilities contribute to odors frequently observed in the community. Although the odors emitted from ZWED are by far the most intense and the most unpleasant, their reach is mostly limited to only the first locations west and south-west of the community in the City of Milpitas. Odors emitted from the NIRRP facility contribute to a large extent to the odors observed at most of the discrete survey locations, while odors emitted from the RWF contribute to a lesser extent at most of the discrete survey locations and more to the further away location in the east and south-east of the community.
- Key findings from the Montrose study are summarized as follows:
  - Unique “chemical fingerprint” distinct to each key odor source were found and confirmed via PCA.
  - Unique “facility fingerprint” detected by PTR-MS agreed with Jacobs odor characterization and quantification results.
  - This study confirms that odorous air samples taken in the nearby community and analyzed by PTR-MS and PCA modeling can be a valid technique to identify which facility (or which facilities) the odors are originating from.
- RWF sources believed to be most impactful to offsite odors include:
  - Primary Clarifiers: Primary effluent launder/box is highly turbulent. The 2015 Odor Control Master Plan (CH2M Hill, 2015) identified the primary clarifiers as a key odor source, but air dispersion modeling

indicated that the distance from this source to the downwind fence line was sufficient to prevent requiring immediate mitigation.

- **Bioreactors:** Because this source covers such a large area and is not contained, it is considered a higher risk odor source for impacting offsite. The mixing zone, which is smaller in area, exhibits higher odor concentrations. However, the larger aerated zones exhibit mostly musty odorants but can still result in offsite odor impacts depending on receptor sensitivity.
- **Digesters:** Anaerobic digesters use PRVs that can experience leakages depending on unit conditions and frequency of maintenance. Because biogas is typically very potent, even a small leak can create significant odor impacts.
- **Lagoons:** Although lagoons were found to exhibit low to moderate odor strength, their size and potential to emit stronger odors under certain wind conditions cannot be neglected. Laminar winds coming off the estuary from the west can chop up the water cap and carry odors into the downwind neighborhood with minimal mixing/dilution. Under calmer wind conditions, the water cap provides a barrier and oxidation zone that limits emissions from the surface.
- ZWED generally does not maintain good odor containment and consistent odor treatment via the biofilters, and this should be investigated further. Due to highly odorous and offensive interior space odors, roll-up doors must remain closed. ZWED should keep diligent in maintaining good housekeeping practices (e.g., the roof-mounted carbon vessel was found to be detached from inlet ducting during one of the sample events). The biofilter should be well irrigated and media replaced once excessive fines are developed.
- ZWED sources believed to be most impactful to offsite odors include:
  - **Interior Space Open Doors:** The ZWED interior space odors are extremely strong and should be contained to the fullest extent possible. Doors should remain closed when not in use (i.e., when deliveries or transportation of material are not occurring).
  - **Biofilters:** Biofilters can be a significant source of odors if not properly operated. Media should be properly wetted and changed out when consolidation of fines occurs. The metric for media changeout should be verified by the media Supplier but can be expected to be roughly equivalent to an increase in pressure drop across the media of approximately double its original condition.
- NIRRP has improved control of odor emissions significantly over the years including the following:
  - Dedicated area of the working face for ZWED residuals and expeditiously covering up residuals with less odorous material (e.g., biosolids cake material).
  - In 2020, a project was completed in which gas collection header piping was upsized. The larger header addressed bottlenecks for mitigating the gas fugitive odors previously observed around the site. A replaced header was provided with proper slopes and condensate control.
  - Implementation of eight separate misting systems around the site and along the fence line.
  - Replacement of windrow compost piles with ASPs for composting. Composting piles were further covered with a biolayer to biologically oxidize any odor emissions.
  - Green waste and grinding moved from earlier location.
  - NIRRP not receiving wet materials since May 2020. All wet material is delivered directly to ZWED to reduce odors.
  - Special misting system used when biosolids stockpiling occurs in October.
- NIRRP sources believed to be most impactful to offsite odors include:
  - **Landfill Gas:** The landfill gas was the most potent of all sources investigated in the Study. However, because landfill gas is contained in piping systems, negligible offsite odor impacts are currently

observed. However, because of the higher risk associated with this source due to its strong potency, all means to prevent gas leaks from occurring should be practiced as gas leaks are still clearly noticeable onsite.

- Working Face: The working face exhibits strong odors exhibiting rancid, sweet, and garbage characteristics.
  - Green Waste Receiving and Grinding Area: This source was found to exhibit strong odors.
  - Biosolids Stockpiling Area: Odors from this source were moderate to mild. Emissions can vary depending on agitation and moisture levels. This source can be a strong emitter when agitated or fresh and misting is not operating.
  - CASP Contact Water Ponds: This source was found to be moderately strong, although it is a relatively small source (i.e., small plume size).
- Other sources:
    - San Francisco Bay: The estuary west of the key facilities (and immediately west of the RWF lagoons) can be an odor source impacting the Milpitas community depending on wind conditions and tidal conditions. During low tide, exposed decomposing organic material in Bay mud can be a source of odors.
    - Estuary Culvert: During Sample Event 3, an estuary culvert was found to be draining septic water onto a gravel discharge area, creating turbulence and off-gassing.

## 4. Evaluation of Odor Monitoring Techniques

In addition to determining the contribution of odor-causing compounds from the odor-emitting facilities, a key objective of this Study is to develop a strategy (presented in Section 5) for measuring the frequency and concentration that these odor-causing compounds may be migrating into the local community. This section evaluates odor monitoring methods and equipment that may be used to develop the strategy for ongoing odor measurement.

### 4.1 Overview of Odor Monitoring Techniques

There are two basic forms of odor monitoring: (1) active monitoring, and (2) passive monitoring. Active monitoring refers to continuous monitoring with high frequency (seconds or minutes), while passive monitoring refers to the infrequent analysis of the sampled air (such as monthly or seasonally). Active monitoring uses continuously monitoring sensors, while passive monitoring typically involves air sampling, followed by analysis at a laboratory or with a specific analytical apparatus. The active monitoring instruments or sensors typically can only measure one or a few odorous compounds, whereas passive monitoring can be used to evaluate many different compounds in the odorous air typically around facilities or in the community.

Active monitoring is required for the odor monitoring system to meet the 24/7 monitoring requirement to collect information about potential odor complaint events, to support the identification of the odor sources. Active monitoring also could provide reliable meteorological data that can be used for odor source identification or ongoing odor dispersion modelling purposes. Passive monitoring may be used to help characterize and identify the different odor sources at the odor-emitting facilities when active monitoring alone is not effective.

Each odor source releases a distinctive combination of odorous compounds. Both active and passive monitoring can be used to measure concentrations of odorous compounds from a specific source, referred to as source monitoring, or can be used to measure ambient air concentrations of odorous compounds at a specific point within the facility, at the fence line, or surrounding the facility. The odorous compounds for each source could be characterized by passive monitoring, while the changes over time of certain types of odorous compounds can be monitored using an active monitoring sensor.

Passive source monitoring can involve the following techniques:

- Air samples collected in a bag or a canister, shipped to the laboratory for chemical analysis
- Air samples collected in a bag, shipped to the laboratory for olfactometric analysis
- Field olfactometric surveys/analysis (including community responses)

Active source monitoring can involve the following techniques:

- Electro Chemical sensors (conducting polymers and quartz crystal/ chemically active sensors)
- Semiconductor Metal Oxide sensors
- Infrared sensors
- Photo Ionization Detection meters
- Flame Ionization Detection meters
- Semicontinuous GC/MS instruments
- PTR-MS instruments

Selected methods and devices are described in the following sections.

#### 4.1.1 Olfactometry Methods

Olfactory methods use the sense of smell by the nose and can provide a direct measurement of the human response to odor stimuli. Several standards have been developed to quantify odors.

Most used is the dynamic olfactometry analysis, which is a standardized methodology (ASTM E679/ CEN EN 13725) used for determining the concentration of odors under controlled conditions (olfactometric laboratory). Odor intensity is determined in accordance with ASTM Method E544-104 also under controlled conditions. ASTM Method E544 is the standard reference method most widely used for quantifying odor intensity. This method references the odor intensity of an odor sample to eight concentrations of a reference odorant.

Field inspection methodology may also be used and is standardized by EN 16841:2016. It is a field analysis that uses a panel of people (from two to eight) who assess the presence or absence of an odor directly in the ambient air. Two different methods may be used: Grid and Plume method (EN 16841-1 2016 and EN 16841-2:2016 2016). The grid method uses panelists to characterize odor exposure in a defined assessment area over a sufficiently long period (typically 1 year) to include all different meteorological conditions of that location. Conversely, the plume method uses panelists to determine the extent of the odor impact, under a specified emission situation (based on the source characteristics) and meteorological conditions (including specific wind direction, wind speed, and boundary layer turbulence). Back trajectory analysis can be conducted to determine the source of the odors when meteorological conditions are considered.

A field olfactometer may also be used and involves a self-contained portable olfactometer that, for example, uses compressed air from a high-pressure carbon-fiber tank to dilute sample air prior to presentation to the panelist. A sample is drawn using a vacuum generated by the flow of compressed, diluting air through a venturi pump. The dilution ratio of clean odor-free air to ambient sample air is controlled via a calibrated flow regulator valve providing a calibrated series of discrete dilutions. Field olfactometry defines each discrete dilution level as a D/T ratio. The D/T ratio is a measure of the number of dilutions needed to make the odorous ambient air "non-detectable."

Finally, general feedback from the population living near the odor source can be useful to identify the key source(s) and the intensity of the odors emitted. The feedback can be obtained in different ways (such as regular surveys, smart phone apps or complaint form [online/by phone]). The data obtained can subsequently be associated with the meteorological parameters recorded by local weather station(s).

The advantage of olfactometric methods is that they can be highly sensitive (the sensitivity and selectivity of the human nose is higher than electric instruments). Unfortunately, the methods are slow, often expensive, and are difficult to implement on an ongoing onsite basis.

#### 4.1.2 Chromatography Chemical Analyses Methods

Conventional methods of chemical compound analysis are based on GC/MS, where the components from the odor mixture separate according to their affinity with the stationary phase in the column of the gas-chromatograph. Several types of detectors are available to identify chemical compounds separated by chromatography. The selection of the most appropriate detector depends on the structural characteristics of the compounds being identified and the required detection limits. Mass spectrometry provides a level of confidence in the identification of unknown analytes that no other techniques described here can provide.

A problem that can arise is poor chromatographic separation, which occurs when two (or more) compounds with widely differing retention properties do not chromatographically separate because the later compounds remain in the column too long. Changing the chemistry of the mobile phase, stationary phase, temperature, and column or plane length are good methods to increase the separation. There are different standardized methods such as

EPA Method TO-17. The methods are highly developed but are slow, often requiring concentration or pre-treatment procedures, and therefore are not well suited for online monitoring. In addition, the equipment is typically developed for laboratory environments and not for outdoor industrial environments. Moreover, operation and maintenance of the instrumentation requires special training.

#### **4.1.3 Chemical Sensors**

The human olfactory system is still regarded as the most important and effective “analytical instrument” for odor evaluation. However, the demand for more objective analytical methods has enhanced the development of sensors potentially imitating the biological system. In the last decades, a large field of scientific research has been devoted to the development of electronic noses, which are based on an array of typical electronic-chemical sensors with partial specificity to a wide range of odorants and an appropriate pattern recognition system. In contrast to specific gas sensors, which are required to be highly exclusive to a single chemical species, sensors for electronic noses need to give broadly tuned responses like the olfactory receptors in the human nose. In both cases, the odor quality information and recognition is ensured by the entire pattern of responses across the sensor array rather than the response of any one sensor. Many different types of gas sensors are available. However, currently, commercial instruments consider two main types of gas sensors (metal oxide and conducting polymer resistive sensors). Recent studies are focused on the evaluation of other types of solid-state gas sensors. The classification of chemical sensors can be realized according to the transducer used. The various categories of solid-state chemical sensors are differentiated by the physical principle of the signal transduction. A classification of the solid-state chemical sensors is given in Table 4-1, showing the principle of operation and the typical methods of sensor fabrication.

**Table 4-1. Classification of Typical Chemical Gas Sensors**

Transducer	Principle of operation	Methods of Fabrication
Conductometric	Electrical Conductivity: • Conducting Polymers • Metal Oxides	PVD Microfabrication MEMS Screen printing
Optical	Absorption; Emission Fluorescence Chemiluminescence Evanescent Wave Fiber Optics	Dip coating MEMS Microfabrication
Electrochemical	Ionic Conductivity: • Amperometric • Potentiometric • Voltammetric	Screen printing Dip coating MEMS Microfabrication
Thermal	Flow of thermal energy: • Catalytic • Pyroelectric • Calorimetric	PVD Microfabrication
MOSFET	Charge capacitive coupling	Microfabrication
Ultrasonic	Piezoelectricity: • QCM • SAW • TFBAR	PVD Screen printing Microfabrication MEMS

PVD = Physical Vapor Deposition

MOSFET = metal–oxide–semiconductor field-effect transistor

MEMS = Micro Electro-Mechanical Systems; QCM = Quartz Crystal Microbalance;

SAW = Surface Acoustic Wave; TFBAR = Thin Film Bulk Acoustic Resonator

Source: Brattoli et al. 2011

#### 4.1.4 Multi-Sensor Devices

Computationally sophisticated multi-sensor devices for odor monitoring are called instrumental odor monitoring systems (IOMS) and are non-specific sensor arrays. This means that they do not measure a specific odorant but the aggregate of chemical compounds including odorants in the air responding to a series of electronic sensors. They are used to detect concentrations and qualities of odors and can be useful when other methods are not applicable. However, they do exhibit specific limitations including:

- Calibration and drifting issues as well as the impact of usually fluctuating environmental conditions, such as temperature, humidity, and particulate matter.
- Lower sensitivity than human olfactory-based analysis, thus are not ready for regulatory odor impact analysis.
- Weakly selective, with the sensor arrays trained to only a handful of odorants, thus non-targeted odorants are missed.

The term electronic nose is sometimes used for these devices and creates the expectation of a capability to measure odors. Measuring chemical properties using electronic sensors is not the same as measuring odor properties using the human nose. The sense of smell provides information about volatile compounds in the air, but only a fraction of all volatile compounds carries useful information for smell. During biological evolution, the sense of smell has been adapted to the reception of specific volatile compounds and to their concentration level. Only some volatile compounds can be called odorant. The sense of smell is not a broadband chemical detector



for all volatile compounds in the air, but a very selective detection for only volatile compounds with certain odor information content. In addition, recognition and sensitivity are related to, for example, presence and quality of food, good and bad memories, or information of danger. Traditional gas sensors, when compared to the nose, are weakly selective and do not have the specific filter function for odorants like biological odor receptor cells. In other words, electronic noses lack in sensitivity and specificity.

The method of training and application for applying IOMS is typically not sufficient to achieve a guaranteed useful result. It is not a technical deficiency, but rather a matter of methodology. In addition, caution is advised when applying IOMS in industrial environments, as studies on IOMS are typically only in laboratory settings under well-defined but narrow conditions. Success is limited to specific conditions, which removes the robustness and reliability needed for application in industrial outdoor environments. Changing influent composition, as well as changing process conditions, of odorous process units affect the chemical composition of volatile compounds in the foul air, with usually fluctuating environmental conditions, such as temperature, humidity, and particulate matter.

Nevertheless, an IOMS has potential, especially to classify “unhealthy” or sub-optimum conditions, that would require interpretation to support odor identification at an industrial environment close to odor emitting facilities. While intense research in IOMS technology has resulted in significant progress in the field of continuous odor monitoring, more successful long-term case studies are still needed to overcome the early overoptimistic performance expectations (Conti et al., 2020; Munoz et al. 2010).

#### **4.1.5 Proton Transfer Reaction Mass Transfer**

PTR-MS is a relatively new technique that makes it possible to detect most VOCs with high sensitivity (ppb down to ppt range) without the need of concentration or sample preparation. PTR-MS is the implementation of chemical ionization by proton transfer typically from protonated water molecules. An intense beam of  $H_3O^+$  ions is produced in a hollow cathode discharge source and enters a drift tube where the ions are driven by a homogeneous electrical field and can interact with the air mixture to be analyzed. Every molecule with a proton affinity higher than that of water will eventually interact with the  $H_3O^+$  ions exchanging the proton. The produced protonated air compound ion is then detected by a commercial quadrupole mass spectrometer. The ion signal at a certain mass is linearly dependent on the concentration of the precursor VOC in the sample air. PTR-MS can detect compounds with a proton affinity higher than water, which are most volatile compounds typically found in foul air from waste management processes.

The PTR Instrument provides a means of quantifying specific odorous compounds and their correlations to other compounds (“fingerprints” or “signatures”). A fingerprint identifies its unique set of compounds and/or compound ratios and can be used with downwind measurements and meteorological data to attribute the fugitive plant-wide emissions to an attribution set or grouping of odorants for each facility. Multivariate analysis can be used to better manage the complexity of the spectrometric data. PCA of the PTR-MS fingerprints allow the visualization of the differences between air samples.

PTR-TOF-MS technology is a relatively new disruptive real-time technology that allows an organization to immediately respond to gaseous emissions. It provides real time one data point per second response and may manually be used as mobile device or used in a mobile van or fixed on a specific air quality monitoring pole or fence line. The instrument runs on distilled water and electricity. The identification of compounds, and attribution of those compounds to specific facilities using processes and sources by PCA multivariate analysis.

The technology is performed according to EPA reference methodology and new methods in ASTM documents. It follows EPA reference method protocols and quality assurance/quality control to provide legally defensible data. The technology is immune to moisture and carbon dioxide interference and has ultimately very few interferences.

PTR-TOF-MS provides immediate response, and ultra-low ppt detection limits that are anticipated to be around 100 to 250 ppt for most identified compounds.

## 4.2 Odor Monitoring Requirements

In general, the odor monitoring system (i.e., the design and associated equipment) will have to:

- Provide continuous odor monitoring along with simultaneous meteorological data collection on a 24/7 basis
- Involve active monitoring of odor plumes at the fence line and/or in the community
- Collect detailed information for stakeholders when an offsite event occurs
- Have a supplier's warranty, and a service and maintenance contract
- Provide good repeatability, providing confidence in reanalysis data sets
- Provide a high level of certainty of providing technical support during its future operations
- Conform to the latest editions of applicable standards and codes such as:
  - Life Safety Code (NFPA-101-HB85)
  - American National Standards Institute (ANSI)
  - National Electrical Safety Code (ANSI C2-1987)
  - National Electrical Manufacturers Association
  - Institute of Electrical and Electronic Engineers
  - Instrument Society of America
  - OSHA
  - ASTM
  - Underwriters Laboratory, Inc.

## 4.3 Evaluation Criteria and Conclusions

A high-level multiple criteria analyses was undertaken to evaluate different techniques that could be used as part of an odor monitoring strategy specifically for the odor emissions impacting the community near the three source facilities.

The different odorous compound measuring methods have been evaluated for the following parameters:

- Continuous and ongoing measuring capabilities
- Proven technology (legally defensible)
- Selectivity (to distinguish sources)
- Mobility (handheld/in a mobile van/fixed on a monitoring pole)
- Operation intensity
- Requirements for data processing
- Calibration requirements
- Reliability
- Maintenance requirements
- Cost

The results are summarized in Table 4-2. Based on the evaluation, the following conclusions are made:

- Active (continuous) monitoring of odors will require field sensors.
- Field sensors are not capable of identifying all the different odorous compounds (including their odor concentrations) emitted from the main odor emitting facilities in this Study. The work conducted under this

Study has identified specific subsets or groupings of odorants unique to each facility. Field sensors would be selected to target those subsets of groupings to produce adequate source attribution.

- An array of sensors will be required to measure responses from these different odorous compounds.
- Field sensors may not be sensitive enough for ongoing odor monitoring when located in the community and will have to be installed near odor-emitting facilities (at the facilities or their fence line).
- To attribute the odors experienced in the community to a specific source (or specific sources) may require supplemental passive odor sampling (infrequent analysis of the sampled air in a laboratory).

Table 4-2. Summary of High-Level Multiple Criteria Analyses Different Odorous Compounds Measuring Methods

Relevant Parameter  Method of Ongoing Monitoring	Olfactometric (using the nose)			Chemical Composition			Field Sensors					
	laboratory	mobile		laboratory	mobile		individual compound sensors					array of sensors
	Lab Olfactometry	Field Olfactometry	Public Odor Notifications (phone apps)	GC-MS	semi-continuous GS-MS	PTR-TOF-MS	EC	MOS	FID	PID	Infrared	IOMS
continuous and real-time	--	--	+	--	-+	-+	+	+	+	+	+	+
proven technology (legally defensible)	+	+	+	++	+	+	-	-	+	-	+	+
selectivity (to distinguish sources)	+	+	+	+	+	++	-	-	-	-	-	-+
mobility	--	+	++	--	-+	-+	-	-	-	-	-	-
operation intensive	--	-	+	--	--	--	-+	-+	-+	+	+	-+
requirement for data processing	-+	+	+	--	--	--	-+	-+	-+	-+	-+	-+
calibration requirements	--	--	+	--	--	-+	-	-	+	-+	-+	-+
reliability	+	-+	+	-+	-+	-+	-	-+	+	+	+	-+
maintenance requirements	-+	+	++	--	--	-+	-+	-+	-+	-+	-+	-+
cost	-	+	++	--	--	-	+	+	+	+	+	+
++ good/high/minimum requirements + okay/medium high/hardly requirements -+ reasonable/medium/some requirements - not okay/medium low/ considerable requirements -- not good/low/high requirements												

## 5. Strategy Development for Ongoing Odor Measurement

This section presents the development of a strategy for ongoing measurement of potential odor-causing compounds. A concept approach for ongoing measurement of odors emitted from the main odor emission facilities that may be migrating into the local community is developed specific to the situation in the Study area located within the San Francisco Bay Area. The purpose and the minimum requirements of the strategy are listed, the main components of the odor measurement system are specified, and a conceptual-level layout of the overall system configuration is drafted.

### 5.1 Purpose and the Requirements of the Strategy

Odor complaints data are currently collected by BAAQMD which employs a complaint-based standard for odor control. An odor issue exists if they receive more than 5 confirmed complaints per year averaged over the last 3 years. This threshold of complaints is clearly met for the community near the three source facilities and the odor impact is considered to cause a "significant impact." Penalties can be imposed on facilities that do not satisfy the progress in reducing odor impacts. Although BAAQMD does not stipulate fence line odor concentrations, it recognizes that some facilities are regulated by other lead agencies that may have odor standards (CalRecycle regulates landfill and composting facilities).

The odor monitoring method should be able to identify the most likely source(s) of the odor emissions and provide detailed information about odor complaint events. The purpose of the odor monitoring is (1) to inform stakeholders defining future actions to reduce odors, (2) to help establish methods to measure progress on future odor reduction actions, and (3) inform and educate the community on odor-causing compounds. The odor monitoring method should also provide information about environmental conditions (weather condition such as wind direction and wind speed) and the likelihood of contributing source(s) that may cause odor complaints.

The odor monitoring should therefore be a proactive approach that is continuous to allow the possibility of obtaining ongoing information to support the decision-making process. This requires the use of sensors to measure odors (i.e., relevant odorous compounds) as well as meteorological data (i.e., wind characteristics).

The minimum requirements for the ongoing odor monitoring strategy should therefore include the following:

- **Active (continuous) measurements of the odors at the source or the fence line** of the main odor-emitting facilities. Active measuring means detection with a high frequency (i.e., seconds or minutes) of ambient air concentrations of relevant odorous compounds at a specific point within the facility, at the fence line or surrounding the facility.
- **The ability to provide real-time monitoring on a 24/7 basis.** Real-time monitoring means measuring at the actual time during an odor event in which input data is processed within milliseconds so that it is available virtually immediately (dashboard). This dashboard supports the decision-making process in that it can predict or confirm odor complaints and would enable a direct (proactive) approach from the odor-emitting facility to react swiftly by changing processes, initiating odor control measures, or delaying certain maintenance activities that may cause increased odor emissions.
- **Collection of total odors emitted from the main odor-emitting facilities.** The total odors emitted can either be reported in absolute odor concentrations (i.e., detection to threshold value) or reported in relative concentrations (e.g., a sensor response change) depending on what current odor sensor technology allows.
- **Support for the collection of environmental condition data, including reliable meteorological parameters** that can be used to evaluate odor emissions. Wind direction and wind speed are critical parameters determining how emitted odors travel into the nearby community. To evaluate how odor emissions travel from odor sources into the community requires understanding the local meteorological conditions and may

be visualized by an odor dispersion model. A dynamic odor dispersion model combines real-time odor measurements with the real-time measurement of critical meteorological parameters.

- **Support for the identification of the odor emission source(s).** This requires sensors that can identify odor compounds specific to odor-emitting sources (i.e., odor compound specific sensors) and/or sensors that help identify the origin of the odor-emitting sources (i.e., wind sensors).
- **Identify and measure the concentration of odor causing compounds critical to the community.** To inform and educate the community on the compounds that cause odors that may be relevant to health concerns requires the identification of the odorous compounds including their concentrations. The odors emitted from the main odor-emitting facilities have been shown to be mixtures of many compounds at various concentrations. Some compounds may contribute to odors at sufficiently high concentrations to be problematic, while others may not.

## 5.2 Main Components of an Ongoing Odor Measurement System

To meet the requirements detailed above, an ongoing odor measurement system should be installed at each of the three source facilities that includes the following:

### 1) Sensors Sensitive to the Relevant Odorous Compounds

Because the odors emitted from the main odor-emitting facilities present a mixture of compounds, a multi-sensor device would be required to detect the change of the multiple critical odorous compounds. These multi-sensor devices should be located at several locations at the facilities between the key odor sources and most impacted communities (e.g., near odor sources or along the fence line).

### 2) A Local Weather Station

A continuous collection of reliable meteorological parameters is required to obtain data that is representative enough for odor dispersion modelling in the local area. The geographic conditions in the area of the main odor-emitting facilities (i.e., the presence of the Bay on the northwest and the mountain range on the east) is very specific to this area and may strongly influence the meteorological conditions. Extra wind meters might be required and should be considered at strategic locations.

### 3) A Data Processing and Visualization Platform

An ongoing data processing platform combines the capabilities of the display of air monitoring results, provides warnings and data analyses to better understand which sources of odorous emissions have an impact at the fence line and in the surrounding communities under various meteorological conditions.

It should archive data for operational analysis and regulatory compliance in a separate database and/or a cloud storage with capabilities to generate (daily/weekly/monthly) summary reports. It should also offer a data processing capability using a real-time odor dispersion model, which may include back-tracing of odor complaints to odorous source(s).

The data visualization platform should have different levels of access, which would not only provide information on odors emissions to the facility operators and facility managers, but ideally would also include other stakeholders such as local authorities and community stakeholders. The level of involvement could be up to each facility owner and/or regulator and their needs associated with this effort. Many facility owners want their community to be educated to dispel negative perceptions and ungrounded fears. That level of community involvement can range from providing regular updates on the odor emission to having real-time viewing capabilities for the members of the community to help identify odor issues in the community.

Figure 5-1 illustrates an example of an ongoing odor monitoring system and how the different components typically communicate with each other.

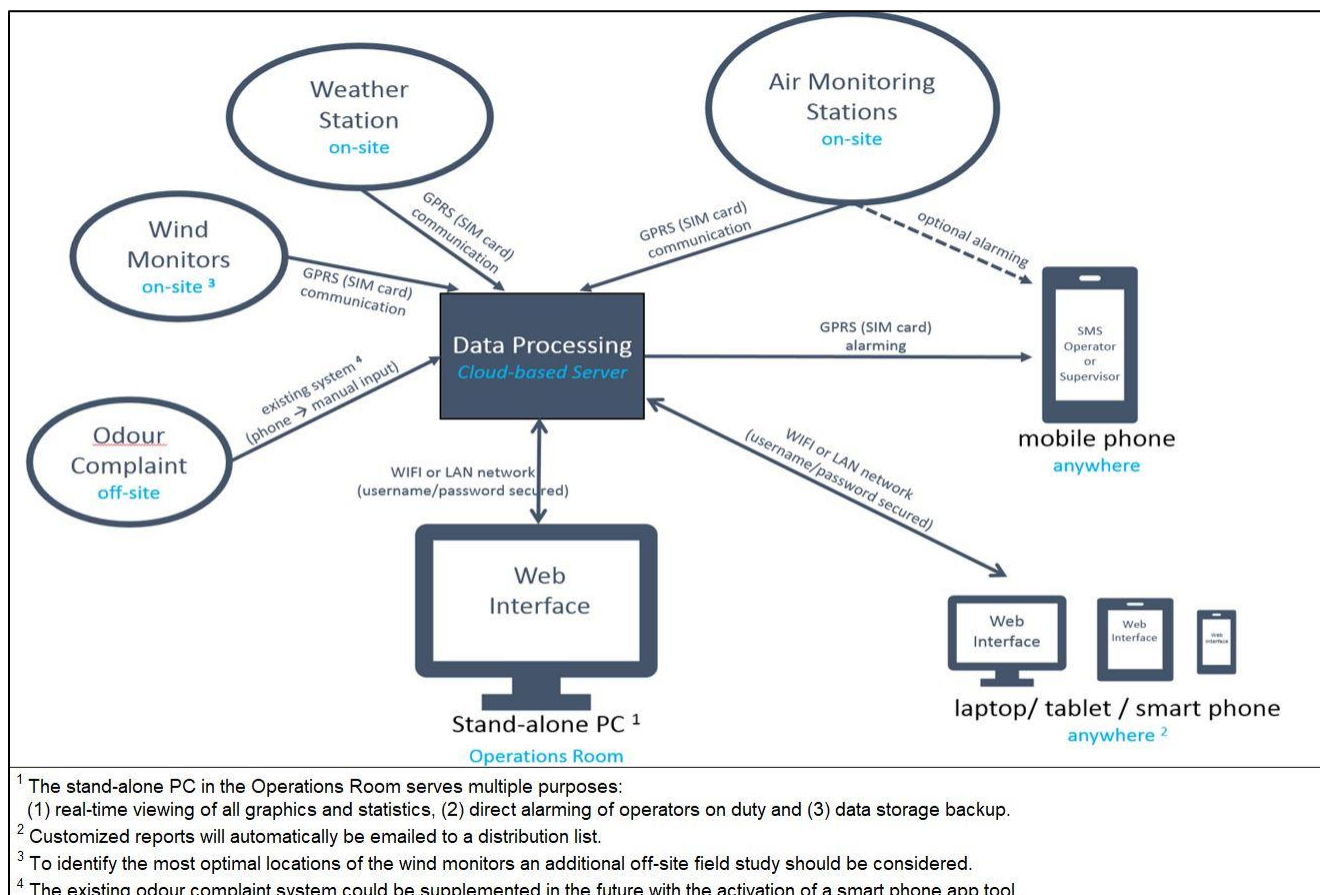

Figure 5-1. Example of Continuous Odor Monitoring System Schematic

### 5.3 Layout of the Ongoing Odor Measuring System

Each main odor-emitting facility should install their own ongoing odor measurement system because it provides ongoing information to support the decision-making process of reducing odor emissions for each individual facility. Facility-specific actions may include changing activities or processes, initiating odor control measures, or delaying certain maintenance activities that may cause increased odor emissions.

A conceptual-level layout of the different devices of the ongoing odor measuring system is illustrated for the main odor emitting facilities on Figure 5-2. A minimum of five multi-sensor devices are likely required, which should be positioned between the key odor sources and the area of the most impacted communities illustrated by a blue circle on Figure 5-2. The five locations are recommended based on the following:

- Placement of a minimum of one multi-sensor device at a downwind fence-line location at each facility (total of three)
- Placement of a minimum of two multi-sensor services at downwind locations between the facilities or within the community. Exact locations would be determined after considering 1) historical odor impacts, 2) ease of implementation when considering site security and infrastructure requirements, and 3) and community stakeholders input.

However, a phased approach could be implemented as follows:

- Phase 1 – Minimum Implementation Scenario. Placement of one or more multi-sensor devices for the purpose of testing the technology and verifying the approach.
- Phase 2 – Moderate Implementation Scenario: Placement of the five multi-sensor devices as described above.
- Phase 3 – Ideal Implementation Scenario: Placement of additional multi-sensor devices at strategic locations for the purpose of obtaining additional data sets and better understanding of community impacts.

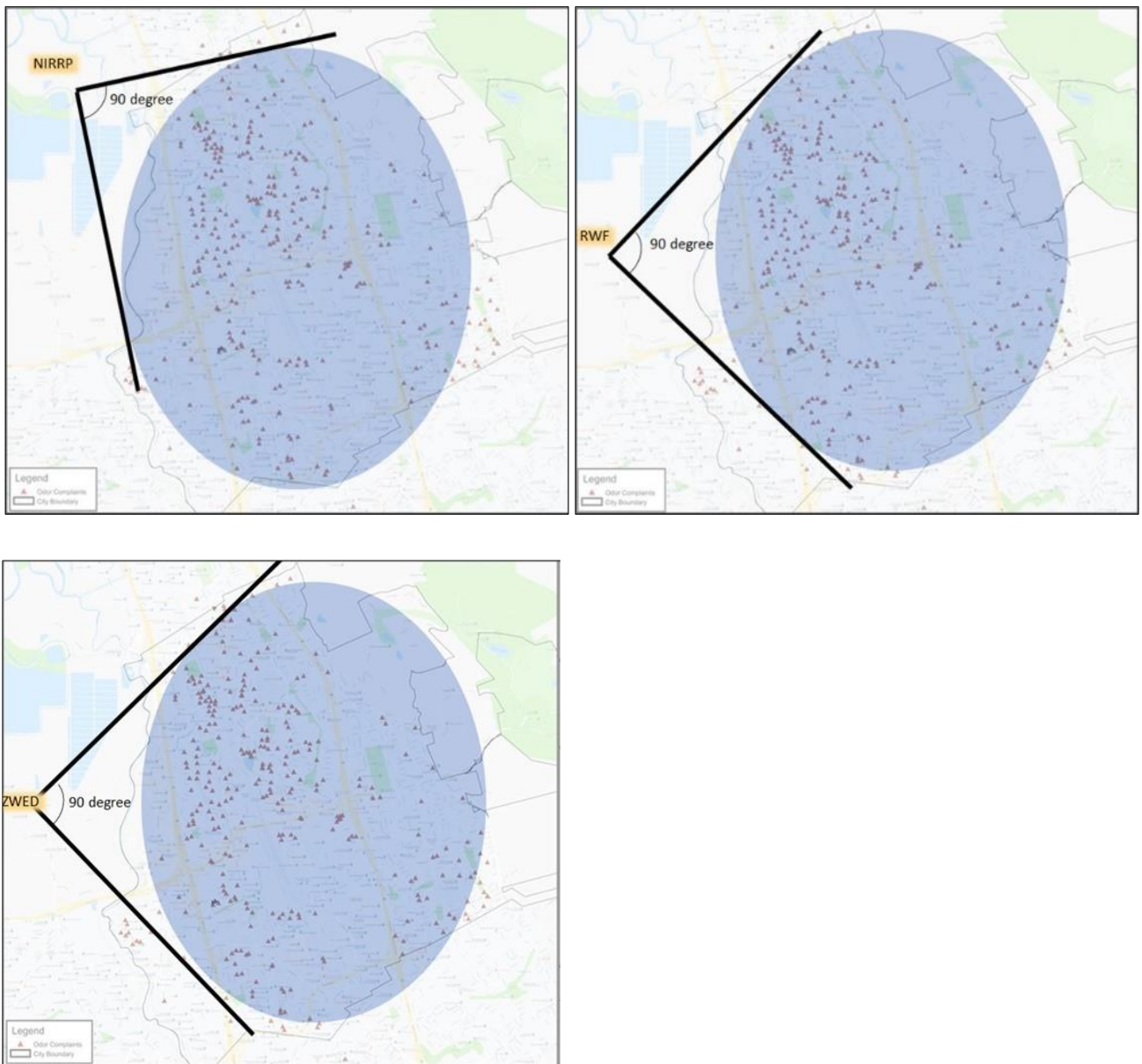

Figure 5-2. Recommended Positioning of Ongoing Odor Measuring System for Main Source Facilities

An example quote for an ongoing odor monitoring system is included in Appendix C. The approximate cost for each odor monitoring station is estimated at \$45,000 plus \$700 for each laboratory analysis.



## 5.4 Ongoing Community Odor Monitoring

An ongoing odor measurement system installed at each of the three main odor-emitting facilities would:

- 1) Inform stakeholders defining future actions to reduce odors
- 2) Help establish methods to validate the effectiveness of odor control improvements and measure progress on future odor reduction actions

But it would not properly inform and educate the community on odor causing compounds.

Informing the community on how to characterize the different odors to understand better where they come from and how they impact the community creates opportunities for optimizing odor-reducing measures. It enables the optimal use of the community in ongoing effort to reduce odor impacts: the community as a tool to help optimize odor mitigation efforts. A well-informed community may also minimize negative perceptions and ungrounded fears. To properly quantify the level of odor nuisance risk and the contribution of each odor-emitting facility to the odors present in the community requires more detailed analyses of the odors arriving in the community.

These more detailed odorous compounds analyses could be best characterized by passive monitoring, which means infrequent sampling of the odorous air and have it analyzed in a laboratory. This Study has shown that each facility has a unique odor chemical "fingerprint" and that the odor contribution of each main facility can be quantified by chemical characterization of the odorous air experienced in the community using PTR technology. In addition, olfactometric analysis of individual odorous air samples can quantify the odor concentrations (i.e., threshold D/T value) and the odor intensity, which together provide a good indication of the risk for odor nuisance.

The strategy for ongoing odor monitoring should therefore not be limited to a continuous odor measuring system at each main odor-emitting facility but should also include periodic odor sampling in the community. This periodic sampling of odors in the community would be best at times when strong odors are experienced and preferably at locations where most odor complaints are typically received from. An auto odorous air bag sampler located at specific locations within the community would enable sampling of odorous air at any time either initiated remotely (e.g., after receiving an odor complaint) or initiated by an IOMS installed at the auto bag sampler.

Although IOMS are not very specific to individual compounds, they can classify "unhealthy" or sub-optimum conditions. They can alert stakeholders or can initiate an air bag sampler for fast collection of air samples within the community for a more enhanced assessment of any odor impact. The auto bag samplers can also be initiated remotely on demand at any moment after receiving odor complaints. The auto air bag sampler takes a sample of the air and stores it in a bag ready for a technician to collect it for shipping to a laboratory in case a detailed analysis is warranted. Due to decay and stability issues pertaining to specific odorants, the bag would likely require same-day collection for overnight delivery to the selected laboratory.

This ongoing odor monitoring system can also assist inspectors in confirming public odor complaints. A public complaint is considered unconfirmed until and unless an inspector can confirm it by smelling it with the complainant and then tracing its source. Confirming an odor complaint is often difficult because the time for an inspector to arrive at the complainant site is typically too long to properly assess the odor complaint and trace its source due to changes in wind direction or process changes at the odor source. An auto bag sampler at specific locations within the community would assist inspectors and allow for more detailed odorous compounds analyses to better understand and more effectively mitigate the odor impacts in the community.

The number of auto bag samplers should be further detailed and is dependent on several factors including historical odor complaints, safe access, costs, and resources available. Installing an auto air bag sampler at the

following locations should be considered as a minimum: Milmont Drive, Tramway Drive, Marylinn Drive, and Murphy Ranch. An example for an auto bag sampler is included in Appendix D.

## 5.5 Concept Approach

The following concept approach for ongoing measurement of odors emitted from the main odor emission facilities that may be migrating into the local community was developed specific to the situation in the Bay Area study area. This approach is similar to the previously described Phase 2 – Moderate Implementation Scenario for placement of multi-sensor devices. Other scenarios are possible and should be considered based on budgetary considerations, community stakeholder input, and technology testing.

This approach should include as a minimum:

- **A continuous IOMS at each of the three facilities, where each odor monitoring system has:**
  - At least five multi-sensor devices, which should be located at several locations at the facilities between the key odor sources and most impacted communities (at the facilities or along southeast side of the fence line between the main odor sources and the most impacted community area)
  - A local weather station, to provide a continuous collection of reliable meteorological conditions (especially local wind direction and speed)
  - A data processing and visualization platform, which could be a web-based data processing server to display data of the monitored data (weather and measured concentrations) and provide individual reporting/alarming
- **Auto air bag samplers at a few strategic locations within the most impacted nearby community** and at the following locations as a minimum: Milmont Drive, Tramway Drive, Marylinn Drive, and Murphy Ranch. This would enable sampling of odorous air at any time either initiated remotely (e.g., after receiving an odor complaint) or initiated by an IOMS installed at the auto bag sampler. The auto air bag sampler takes a sample of the air and stores it in a bag ready for a technician to collect it for shipping to a laboratory in case a detailed analysis is warranted. Each auto air bag sampler station will require the following considerations prior to implementation:
  - Specific design requirements including sample pump, tubing, sample bag container, weather protection features, security measures such as fence with razor wire and camera, ease of access for staff for installing and picking up bags and servicing equipment
  - Power requirements for pump, security features, and communications
  - Communication protocol such as radio, cell, or ethernet

## 6. Findings and Recommendations

This section provides a discussion of general findings, conclusions, and recommendations from the Study including the Jacobs, UCLA, City of Milpitas and Montrose odor and compound characterization and identification efforts and the development for ongoing odor measurement efforts.

The Study successfully met the originally defined goals and objectives of the project. The Study can be considered one-of-a-kind in that it included multiple innovative facets that contributed to obtaining a clearer understanding of odor attribution from the three key facilities as well as other specific offsite sources. The following Study elements/methodologies were considered essential to meeting the Study's objectives.

- Quantitative laboratory analyses of bag samples collected at the three key facilities as well as upwind and downwind in the community and at specific offsite sources. Results identified "fingerprint" odorants unique to each facility/source for the times of the sampling events. Other offsite sources evaluated included the Milpitas Lift Station, an offsite Bay estuary culvert, and the Bay.
- Qualitative odor analyses of bags sampled at the three key facilities as well as upwind and downwind in the community. Results identified "fingerprint" odor descriptors and intensities for linking offsite odors to sources.
- Quantitative/qualitative OPM analyses of bag samples at the three key facilities and other offsite sources. Results identified and validated odor descriptors and intensities. Persistency curves provided understanding of the "peeling the onion" effect and how specific odor types persist as they travel downwind into the community.
- Field olfactometer survey mapping efforts around the three key facilities and downwind into the community. Results provided a clear link between odors in the community and specific facilities/sources. BLOB maps provided an illustrative method for depicting this link.
- Individual compound identification using PTR-MS technology for identifying "chemical fingerprints" unique to each facility/source and confirmed via Principal Component Analysis (PCA). This confirms that odorous air samples taken in the nearby community and analyzed by PTR-MS and PCA modeling can be a valid technique to identify which facility (or which facilities) the odors are originating from.

The methodologies listed above offered results that provided agreement and validation of findings. Furthermore, each methodology was able to provide further supportive evidence for enhancing understanding and building on the other methodology findings. Each methodology implemented was considered essential. This combination of methodologies is truly robust and comprehensive, and to our knowledge has never previously been employed in this way.

The following are key conclusions from the Study:

- The three key facilities, RWF, NIRRP, and ZWED, have all made significant improvements in odor containment and mitigation over the years. However, some sources remain problematic and should be addressed to improve odor control at each facility.
- The RWF, NIRRP, and ZWED each exhibit unique odor and individual compound fingerprints. Therefore, linking community odors to specific sources is achievable.
- Offsite monitoring via field olfactometry was able to link intensities and odor descriptors offsite to specific facilities/sources. Wind direction and speed were key variables considered in making the correlation between offsite impacts and emitting sources.

- Odorous samples taken in the community and analyzed by Montrose via PTR-MS technology and PCA modeling can link offsite community odors to specific facilities/sources. It is possible to attribute plume ratios at a given location in the community to upwind odor sources.
- Odor monitoring systems consisting of multi-sensor devices, a weather station, and data process platform for visualization and alarming combined with auto bag samplers within the community are good options for future facility and community odor monitoring.
- Follow-on work is recommended including air dispersion modeling, pilot testing of specific monitoring equipment, and implementation of permanent monitoring systems.
- Several odor reducing measures at each facility should be considered as priority when defining future actions to reduce odor impacts. These are considered high level recommendations that will require careful vetting and validation via comprehensive analysis by the specific facility prior to implementation. These suggested measures include the following:
  - ZWED
    - Significantly improve the containment of odors in the indoor space by sealing any openings or providing alarms on roll-up doors if/when doors remain open longer than a reset time. Smoke testing should be conducted to verify building tightness.
    - Prevent odor emissions from activated carbon filters. This may require periodic media testing to check media life and employing good housekeeping practices. Consider a duty/standby arrangement such that continuous treatment occurs when media is being changed out.
    - Minimize odor emitting activities (transport of the final product and residual waste out of the ZWED facility) when the wind is blowing toward the community.
    - Minimize leakage at roof-top PRVs by conducting routine maintenance.
    - Enhance the stabilization process of the organic waste where possible (e.g., through process intensification or through increasing process times). This will reduce odors from the final IVC blowers as well as transported final product.
  - RWF
    - Cover the process areas that have high odor emission rates (i.e., in/outlet of PSTs and inlet bioreactors).
    - Install channel aeration combined with covers and dedicated odor control.
    - Minimize leakage at digester PRVs by conducting routine maintenance.
    - Continue to dose ferrous chloride at the front end of the facility for precipitating dissolved sulfides entering the facility. Consider increasing dosing rate during hotter odor seasons.
  - NIRRP
    - Build a process building with odor control system for the green waste receiving and grinding area.
    - Undertake enhanced and frequent leak detection surveys of the landfill gas system.
    - Measure flaring odor emission rates and potentially pretreat the biogas (i.e., biogas desulfurization).
    - Undertake housekeeping improvements (e.g., cover cake stockpiles when raining, assess and improve leachate management, and prevent stormwater retention from going septic and causing odors).
    - Consider installing a biogas utilization system for energy production.

- Continue expeditious covering of received waste at the working face and consider the use of topical neutralizing agents during warmer odor seasons.
- Milpitas Main Lift Station: Undertake a ventilation study and potentially install a new odor control system.
- Bay Estuary Culvert: Change the discharge from the culvert to minimize turbulence and stripping of odors.

Table 6-1 below summarizes the sources for which abatement is recommended (Jacobs, 2022) and includes the associated odor fingerprints, the associated odor threshold levels (low or moderate), the abatement recommendations, and the facility responsible party.

**Table 6-1. Summary of Odor Abatement Recommendations**

Sources	Odor Fingerprints	Thresholds	Recommendations	Facility Responsible Party
<b>ZWED</b>				
Interior Space	Sweet, Rancid, Musty	Low	Seal openings. Alarm at open doors.	ZWED
Rooftop Carbon Filter <sup>a</sup>	Burned Rubber	Low	Media testing and change out carbon when spent	ZWED
Final Product	Sweet, Rancid, Musty	Low	Limit activities including roll-up door actuation when wind is blowing into community	ZWED
PRVs <sup>b</sup>	Sweet, Burned Rubber	Low	Maintain PRVs to prevent leakage	ZWED
<b>RWF</b>				
Primaries	Sulfur (Rotten Egg)	Moderate	Provide covers at high emitting areas	City of San José
Bioreactors	Sulfur (Rotten Egg, Decaying Vegetables)	Low	Provide covers at inlet/mixing zone	City of San José
Digester PRVs	Sweet, Burned Rubber	Low	Maintain PRVs to prevent leakage	City of San José
Liquids	Sulfur (Rotten Egg, Decaying Vegetables)	Low	Continue dosing ferrous (consider optimization)	City of San José
<b>NIRRP</b>				
Green Waste	Pine, Rancid, Sulfur	Low	Build process building for odor containment and ventilate to vapor phase odor abatement system	NIRRP
Landfill Gas	Rancid, Sweet, VOCs	Low	Continue leak detection surveys	NIRRP
Flares	Mixture (primarily sulfur)	Low	Measure odor content and consider pre-treatment (if necessary)	NIRRP
Multiple Sources <sup>c</sup>	Multiple	Low	Good housekeeping practices	NIRRP
Biogas/Landfill Gas	Rancid, Sweet, VOCs	Low	Consider biogas utilization system for energy production	NIRRP
Milpitas Lift Station	Sulfur (Rotten Egg)	Moderate	Ventilation study and new odor control system (currently being implemented)	City of Milpitas

Sources	Odor Fingerprints	Thresholds	Recommendations	Facility Responsible Party
Estuary Culvert	Sulfur (Rotten Egg)	Moderate	Change outlet to reduce turbulence and stripping	City of San José

Notes:

PRV = Pressure relief valve

<sup>a</sup> Carbon filter abating biogas bladder interstitial space

<sup>b</sup> PRVs serve digesters, percolate tanks, and gas holder

<sup>c</sup> Multiple sources include cake stockpiling, leachate tanks, and stormwater pond

Recommendations for Ongoing Odor Monitoring Strategy are as follows:

- Install an odor monitoring system at each of the three facilities that consists of:
  - Several multi-sensor devices
  - A weather station
  - Data process platform for visualization and alarming
- Install auto bag samplers within the most impacted nearby communities
- The odor monitoring evaluation found that installing odor monitoring systems at each of the three facilities that consists of several multi-sensor devices, a weather station, and data process platform for visualization and alarming along with auto bag samplers within the community was the preferred approach. The approximate cost for each odor monitoring station is estimated \$45,000 plus \$700 for each laboratory analysis.

Several next steps are recommended for taking the Study further and achieving enhanced odor emissions understanding and response

- **Air Dispersion Modeling:** An AERMOD model or preferably a CALPUFF model would provide quantification of individual source emissions, facility emissions, and combined plume impacts. Results would further refine and clarify current Study findings and conclusions. The most critical aspect of this task would be obtaining accurate meteorological data via a local weather station for capturing complex localized wind conditions.
- **Pilot Testing of Monitoring System:** If BAAQMD is not comfortable either investing in or imposing on the three key facilities to invest in comprehensive odor monitoring, then a small to moderate pilot testing program could be implemented for validating and confirming the proposed monitoring technologies as well as gaining understanding of operation and maintenance requirements.
- **Implementation of Monitoring Systems:** Once stakeholders are comfortable with the proposed odor monitoring approach, full implementation should be carried out. Where deemed necessary, monitoring could be incorporated into specific air permit conditions.

## 7. References

- American Public Health Association (APHA). 2012. "2170 Flavor Profile Analysis." *Standard Methods For the Examination of Water and Wastewater*. <https://www.standardmethods.org/doi/abs/10.2105/SMWW.2882.021>.
- Bay Area Air Quality Management District (BAAQMD). 1982a. *Manual of Procedures Volume IV, Source Test Policy and Procedures*.
- BAAQMD. 1982b. *Source Test Method ST-08, Dimethylsulfide*.
- BAAQMD. 1982c. *Source Test Method ST-11, Mercaptans*.
- BAAQMD. 1982d. *Source Test Method ST-12, Collection of Odorous Samples*.
- BAAQMD. 1982e. *Source Test Method ST-21, Total Reduced Sulfur*.
- BAAQMD. 1982f. *Source Test Method ST-22, Trimethylamine*.
- BAAQMD. 1982g. *Source Test Procedure ST-18, Stack Traverse Point Determination*.
- Brattoli, M., de Gennaro, G., de Pinto, V., Demarinis Loiotile, A., Lovascio, S., Penza, M. 2011. Odour Detection Methods: Olfactometry and Chemical Sensors. *Sensors*. Vol. 11, No. 5. 5290–5322.
- Burlingame, G.A. 1999. "Odor Profiling of Environmental Odors." *Water. Sci. Tech.* 40, 31–38.
- Burlingame, G.A. 2009. "A Practical Framework Using Odor Survey Data to Prioritize Nuisance Odors." *Water Sci. Technol.* 59, 595–602.
- CH2M HILL. 2012. *Odor Source Characterization Sampling Plan Rev. 5*.
- CH2M HILL. 2015. *Odor and Corrosion Control Study*.
- Conti, C., Guarino, M., Bacenetti, J. 2020. Measurements techniques and models to assess odor annoyance: A review. *Environment International*. Vol. 134. January, 105261.
- EN 13725. Air Quality - Determination of Odour Concentration by Dynamic Olfactometry. European Committee for Standardization (CEN).
- Jacobs. 2022. "Consideration for Odor Reducing Measures – BAAQMD Odor Attribution Study."
- Morgan, T., Bornstein, R. 1977. *Inversion Climatology at San José, California*.
- Munoz, R., Sivret, E.C., Parcsi, G., Lebrero, R., Wang, X., Suffet, H., Stuetz, R.M. 2010. Monitoring techniques for odour abatement assessment. *Water Research*. Vol. 44, No. 5: 129–149.
- South Coast Air Quality Management District (SCAQMD). 2006. *Determination of Ammonia Emissions from Stationary Sources*.
- Suffet, I.H. 2016. *Analytical Method Quality Assurance Study for Tedlar and Teflon Sampling Bags for CH2M Hill*.

U.S. Environmental Protection Agency (EPA). 1986. "Measurement of Gaseous Emission Rates from Land Surfaces Using an Emission Isolation Flux Chamber." *User's Guide*.

EPA. 1997. *Procedure for Collection and Analysis of Ammonia in Stationary Sources*.

EPA. 1999a. *Compendium Method TO-05, Determination of Aldehydes and Ketones in Ambient Air Using High Performance Liquid Chromatography (HPLC)*.

EPA. 1999b. *Compendium Method TO-11A, Determination of Formaldehyde in Ambient Air Using Adsorbent Cartridge Followed by High Performance Liquid Chromatography (HPLC)*.

EPA. 1999c. *Compendium Method TO-14A, Determination Of Volatile Organic Compounds (VOCs) In Ambient Air Using Specially Prepared Canisters With Subsequent Analysis By Gas Chromatography*.

EPA. 1999d. *Compendium Method TO-15, Determination of Volatile Organic Compounds (VOCs) In Air Collected in Specially-Prepared Canisters And Analyzed By Gas Chromatography/Mass Spectrometry (GC/MS)*.

EPA. 1999e. *Compendium Method TO-17, Determination of Volatile Organic Compounds in Ambient Air Using Active Sampling Onto Sorbent Tubes*.

EPA. 1999f. *Environmental Restoration Division Standard Operating Procedure 1.11, Soil Surface Flux Monitoring of Gaseous Emission*.

EPA. 2012. *Emission Testing Methodology for Air Pollution*.

Water Research Foundation (WERF). 2008. *Biosolids Processing Modifications for Cake Odor Reduction*. IWAP ISBN: 1-84339-790-0. Accessed November 19, 2021. <https://www.waterrf.org/research/projects/web-based-biosolids-odor-reduction-roadmap-borr-tool>.

Wold, S., Esbensen, K., Geladi, P. 1987. 52 Principal Component Analysis. *Chemometrics and Intelligent Laboratory Systems*. Vol. 2: 37-52.



**Appendix A**  
**Sampling and Odor Survey Plan**



# Odor Attribution Study

## Sampling and Odor Survey Plan

FES0727201046SFB | Revision 2  
September 2020

### Bay Area Air Quality Management District

#### Document history and status

Revision	Date	Description	Author	Checked	Reviewed	Approved
0	08/13/2020	First issue	BK., SC, GT, NR, ML	ML	JW	JW
1	08/31/2020	Final	BK, SC, GT, NR, ML	ML	JW	JW
2	09/11/2020	Revised for additional comments	BK, SC, GT, NR, ML	ML	JW	JW

#### Distribution of copies

Revision	Issue approve	Date issued	Issued to	Comments

## Odor Attribution Study

Project No: W8Y05600  
Document Title: Sampling and Odor Survey Plan  
Document No.: FES0727201046SFB  
Revision: Revision 2  
Date: September 2020  
Client Name: Bay Area Air Quality Management District  
Project Manager: Jay Witherspoon  
Author: Bart Kraakman, Scott Cowden, Giuseppe Tomasino, Niranjana Rajagopalan, Mia Lindsey  
File Name: BAAQMD\_Sampling Plan\_Rev2

Jacobs

4 Embarcadero Center, Suite 3800  
San Francisco, California 94111  
United States  
T +1.415.356.2040  
F +1.415.356.2055  
[www.jacobs.com](http://www.jacobs.com)

**© Copyright 2020 Jacobs. The concepts and information contained in this document are the property of Jacobs. Use or copying of this document in whole or in part without the written permission of Jacobs constitutes an infringement of copyright.**

Limitation: This document has been prepared on behalf of, and for the exclusive use of Jacobs' client, and is subject to, and issued in accordance with, the provisions of the contract between Jacobs and the client. Jacobs accepts no liability or responsibility whatsoever for, or in respect of, any use of, or reliance upon, this document by any third party.

**Contents**

**1. Introduction ..... 1-1**

1.1 Purpose and Objectives ..... 1-1

1.2 Description of Study Area..... 1-2

1.3 Description of Odor-Emitting Facilities of Focus ..... 1-3

1.3.1 Newby Island Resource Recovery Park..... 1-4

1.3.2 San José-Santa Clara Regional Wastewater Facility ..... 1-11

1.3.3 Zero Waste Energy Development Facility ..... 1-15

1.4 Description of Receptor Areas..... 1-20

**2. Field Sampling and Surveying Locations ..... 2-1**

2.1.1 Sampling Summary Matrixes ..... 2-2

2.1.2 Newby Island Resource Recovery Park Sampling Locations ..... 2-1

2.1.3 RWF Sampling Locations ..... 2-1

2.1.4 ZWED Sampling Locations ..... 2-3

2.1.5 Field Olfactometric Survey Locations ..... 2-3

**3. Sampling Approach and Methodology ..... 3-6**

3.1 Sample Collection Methodology ..... 3-6

3.1.1 Flux Chamber Sampling (for area sources – liquid and solid surfaces) ..... 3-7

3.1.2 Bag Sampling (for flux chamber emissions and point sources)..... 3-9

3.1.3 Sorbent Media Sampling ..... 3-10

3.1.4 Summa Canister Sampling (TO-15 if implemented)..... 3-10

3.1.5 Methane Measurements ..... 3-10

3.1.6 High Temperature Source Sampling..... 3-10

3.1.7 Explosive Source Sampling..... 3-11

3.2 Laboratory Analytical Methods ..... 3-11

3.2.1 Odor Profile Method..... 3-13

3.2.2 Laboratory Analyses for Constituent Groupings ..... 3-16

3.2.3 Olfactometry..... 3-18

3.3 Field Surveys/Measurements ..... 3-19

3.3.1 Olfactometer..... 3-19

3.3.2 Meteorological Data Collection ..... 3-20

3.3.3 Field Hydrogen Sulfide and Ammonia ..... 3-20

3.3.4 Continuous Hydrogen Sulfide Monitoring ..... 3-20

3.3.5 Pressure/Flow Measurements ..... 3-20

3.4 Shipping & Lab Coordination ..... 3-21

**4. Field Procedures ..... 4-1**

4.1 Field Equipment ..... 4-1

4.2 Quality Assurance / Quality Control..... 4-2

4.2.1 Chain of Custody Procedures ..... 4-3

4.3 Health and Safety ..... 4-3

5. Communication..... 5-1

6. References..... 6-1

**Tables**

Table 1-1. Key Potential Odor Sources and Expected Odorant Groupings for NIRRP ..... 1-11

Table 1-2. Key Potential Odor Sources and Expected Odorant Groupings for RWF..... 1-15

Table 1-3. Key Potential Odor Sources and Expected Odorant Groupings for ZWED ..... 1-20

Table 1-4. BAAQMD Received Odor Complaints, South Bay (2015 to 2019) ..... 1-21

Table 1-5. Locations of Highest Number of Complaints (2017 to 2019) ..... 1-21

Table 2-1. Summary of Planned Sampling Events ..... 2-2

Table 2-2. Sampling Event 1 Summary Matrix..... 2-3

Table 2-3. Sampling Event 2 Summary Matrix..... 2-5

Table 2-4. Sampling Event 3 Summary Matrix..... 2-6

Table 3-1. Summary of Targeted Sampled Odorant and Protocols ..... 3-11

Table 3-2. Analytical Methods Test Plan ..... 3-13

Table 3-3. List of Sub-compounds for Selected Tests ..... 3-17

Table 3-4. List of 61 Standard VOCs Using Method TO-17 ..... 3-17

Table 4-1. Summary of Field Quality Control Information..... 4-3

Table 5-1. Project Contacts..... 5-1

**Figures**

Figure 1-1. Key Odor-Emitting Facilities and Surrounding Communities ..... 1-3

Figure 1-2. Facility Interactions ..... 1-4

Figure 1-3. Newby Island Resource Recovery Park Facility Map, Milpitas, California (source: Google Earth) ..... 1-5

Figure 1-4. MRF Sorting Area ..... 1-6

Figure 1-5. Newby Island Landfill Green Waste Facility..... 1-8

Figure 1-6. Newby Island Landfill Composting Process ..... 1-9

Figure 1-7. Landfill Gas Header..... 1-10

Figure 1-8. San José-Santa Clara RWF Overview (CH2M Hill 2012) ..... 1-12

Figure 1-9. RWF East Primary Tanks (Effluent Launderers Inset) ..... 1-13

Figure 1-10. RWF BNR Process..... 1-14

Figure 1-11. RWF Lagoons ..... 1-14

Figure 1-12. ZWED Facility Overview ..... 1-16

Figure 1-13. ZWED Basic Process Steps..... 1-17

Figure 1-14. ZWED Interior Sorting Area ..... 1-18

Figure 1-15. ZWED Open Digester ..... 1-18

Figure 1-16. ZWED Biofilter ..... 1-19

Figure 1-17. Milpitas Historical Complaint Locations (2012 to 2015) ..... 1-20

Figure 2-1. RWF Sludge Drying Beds ..... 2-3

Figure 2-2. Field Olfactometric Survey Locations (source: Google Earth) ..... 2-4

Figure 3-1. EPA Flux Chamber with Sampling Equipment ..... 3-7

Figure 3-2. Sorbent Tubes and Sampling Pumps..... 3-10

Figure 3-3. Weber-Fechner Curves for Various Constituents ..... 3-14

Figure 3-4. Set-up of Indole and Skatole Extraction System..... 3-15

**Appendixes**

**Appendix A Field Log Form**

**Appendix B Health & Safety Plan**

## Acronyms and Abbreviations

°C	degrees Celsius
°F	degrees Fahrenheit
µg/m <sup>3</sup>	microgram(s) per cubic meter
µL	microliter
µm	micrometer
AD	anaerobic digestion
APHA	American Public Health Association
ASP	aerated static pile
BAAQMD	Bay Area Air Quality Management District
BNR	biological nutrient removal
cfm	cubic feet per minute
CHP	combined heat and power
cm	centimeter
CNG	compressed natural gas
CTM	conditional test method
CY	cubic yard
D/T	dilutions to threshold
DAFT	dissolved air flotation thickener
EN	European norm
EPA	U.S. Environmental Protection Agency
fpm	feet per minute
FTIR	Fourier transfer infrared spectrometer
GC	gas chromatography
HPLC	high-performance liquid chromatography
IVC	in-vessel composter

---

Jacobs	Jacobs Engineering Group
L	liter
L/min	liter per minute
m/z	mass-to-charge ratio
m	meter
mgd	million gallons per day
mL	milliliter
mm	millimeter
Montrose	Montrose Environmental Group
MRF	Material Recovery Facility
MRL	method reporting limit
MSW	municipal solid waste
NIRRP	Newby Island Resource Recovery Park
NISL	Newby Island Landfill
OPM	odor profile method
ORS	organic reduced sulfur
OU/m <sup>3</sup>	odor unit per cubic meter
PHSEP	Project Health Safety and Environment Plan
Plan	Sampling and Odor Survey Plan
ppbV	parts per billion by volume
PPE	personal protection equipment
ppmV	parts per million by volume
PRV	pressure relief valve
PTR-MS	proton transfer reaction – mass spectrometer
QA	quality assurance
QC	quality control



RWF	San José-Santa Clara Regional Wastewater Facility
scfm	standard cubic feet per minute
SEM	Surface Emission Monitoring
SM100	Scentroid SM100 field olfactometer
SPME	solid phase microextraction
ST	source test
Study	Odor Attribution Study
TO	toxic organics
TRS	total reduced sulfur
UCLA	University of California at Los Angeles
VFA	volatile fatty acid
VOC	volatile organic compound
ZWED	Zero Waste Energy Development

## 1. Introduction

Jacobs Engineering Group Inc. (Jacobs) was engaged by the Bay Area Air Quality Management District (BAAQMD) to undertake an Odor Attribution Study (Study) that includes gathering data from specific sources and ambient locations to better understand odor impacts within the local South Bay communities of Milpitas, San José, and Fremont, California. This Sampling and Odor Survey Plan (Plan) is designed to support the following Study objectives:

- Identify odorant compounds impacting the area of concern via comprehensive quantitative and qualitative analyses;
- Determine the relative contribution and variability of the odor-causing compounds emitted from three identified key odor-emitting source facilities; and
- Develop a strategy for continuous real-time measurement of these odor-causing compounds from three key odor-emitting sources that may impact the South Bay communities.

To achieve these objectives, Jacobs will undertake tailored field sampling and laboratory analysis for chemical compound identification of specific odorants, and field olfactometry sampling to provide an understanding of the relative contribution and variability of odor-causing compounds from three key odor-emitting facilities and how they impact the local South Bay community. Nuisance-level odors are believed to be principally derived from three South Bay sources, which are the focus of this Study:

- Newby Island Resource Recovery Park (NIRRP), comprised of Newby Island Landfill (NISL), Material Recovery Facility (MRF), and NIRRP composting facility;
- San José-Santa Clara Regional Wastewater Facility (RWF); and
- Zero Waste Energy Development (ZWED) facility.

This Plan has been prepared based on observations made during facility site visits in June 2020 with facility and BAAQMD staff, and on known odor emission sources identified from either BAAQMD or South Bay community-based odor complaint records and logs. The field sampling and laboratory analytical activities will be carried out in accordance with this approved odor emissions sampling and survey plan. The following sections describe the purpose and objectives of this Plan, provide a description of the Study area and preliminary odor observations, outline testing approaches and methodology, and detail sampling locations and events, including a description of the procedures to obtain and document field data to ensure quality control in accordance with BAAQMD standards and procedures.

### 1.1 Purpose and Objectives

The purpose of this Plan is to define the odor sampling locations, sampling methodology, and associated analytical methods to enable the Study team to characterize the most relevant odor and chemical compound (odorant) types at the three odor-emitting facilities and estimate their contribution in the nearby communities. The Plan also addresses sampling at selected community and ambient off-site locations during the facility odor sampling events.

Three odor sampling events are planned to capture seasonal and/or operational events coinciding with the emitting facilities' highest nuisance odor emissions probability that directly impacts the South Bay communities. Each successive odor sampling event's targeted emissions sources and sampling and analytical suite will build upon the previous odor sampling event's findings and results. This study is designed to characterize "worst-case" scenarios. As such, the sampling plan focuses on what are considered high priority sources based on available information.

The sample data collected as part of the three sampling events will be technically reviewed for accuracy and applicability, synthesized, and will be converted to estimated relative emission rates to be used as input into an air dispersion model to meet the following objectives for the air dispersion model:

- Act as an odor exposure analysis tool to determine the most relevant odor sources from each facility regarding off-site odor impacts in the adjacent community;
- Link the ambient field survey work and the emitted sources at each facility by acting as an evaluation tool that “zooms in” to a specific off-site area and identifies the key contributing emitter(s) for specific meteorological conditions;
- Act as an informational tool for understanding the relative seasonal variations of off-site odor impacts from each facility based on the seasonal sampling results and typical seasonal weather conditions; and
- Overlay each facility’s odor concentration at distinct odor complaint hotspots within the community to give an attribution indication (such as which facility is emitting odorant and at what percentage of that odorant at that community hotspot location).

It should be noted that the purpose of the air dispersion modeling in this Study will not be to quantify each and every source at each facility. Instead, the air dispersion model will be used only to help identify the major odor sources for different off-site areas under typical seasonal weather conditions. Historical emission rates from other studies may be considered when performing risk analyses using the air dispersion model to strengthen the conclusions on the ranking of the major odor sources. Categorizing a source as “major” will take into account odor strength, odor characteristic, and odor plume size.

Jacobs will coordinate this Study’s sampling activities with the mobile, real-time odor sampling and tracing activities being undertaken by Montrose Environmental Group (Montrose) in parallel with this Study. Montrose will undertake an odor screening study to identify the wide range of individual compounds and specific markers of the different major odor sources contributing to off-site odor impacts. Montrose will use different real-time analyzers on a mobile platform allowing measurements at various location around the facilities. The analyzers will include proton transfer reaction – mass spectrometer (PTR-MS), Fourier transfer infrared spectrometer (FTIR), and gas chromatography (GC) technologies.

The findings from Jacobs’ sampling activities and Montrose’s mobile sampling results will assist in determining facility odor attributions to the South Bay communities. Specifically, they will:

- Inform future actions to reduce odors (best practices, enforcement, rules);
- Establish methods to measure progress on facilities’ future odor reduction actions;
- Educate the community on what is causing the odors, how complex they are, and how to characterize them, which will aid in better understanding where the odors are coming from.

## 1.2 Description of Study Area

This Study is focused on the cities of San José, Milpitas, and Fremont, located in the South San Francisco Bay Area of California. Currently, these South Bay communities are impacted by residual and nuisance-level odors, resulting in significant odor complaints being submitted by community members to both the facilities’ owners and BAAQMD.

The climate can be categorized as Mediterranean, with mostly sunny weather and without extreme temperature changes. Winter months are relatively mild and cool, ranging from 31 degrees Fahrenheit (°F) to 59 °F. Rainfall occurs periodically with a winter average of 15 inches. The transition to spring brings warmer weather and infrequent rain. Summer months are dry and warm with temperatures averaging in the mid- to high-80s. While it is typically infrequent, temperatures can exceed 100° F. Autumn will bring cooler temperatures; however, it tends to maintain dry and sunny into late October.

Wind speeds vary. Typically during winter, winds are calm (remaining between 5 and 10 miles per hour). During summer, winds are calm during the morning hours and increase gradually during the day to greater than 10 miles per hour at sites along the Bay (such as RWF). Wind direction is predominantly from the west between February and October and from the north between November and January. Even so, wind direction can shift between morning hours and afternoon hours in the summer months.

Bay mud may be considered a significant non-facility odor source, creating background odors that can either mask or worsen odor impacts from odor emitting facilities. Furthermore, tidal variation can impact bay mud emissions. During low tide, decaying organics are exposed and produce the strongest odor. Many complaints tend to come in at around 6:00 PM when residents arrive home lending to increased sensitivity. Where tidal conditions occur simultaneously with this timeframe, odor impacts can be exacerbated. For this reason, upwind, downwind, and community locations will be characterized as part of this sampling endeavor.

### 1.3 Description of Odor-Emitting Facilities of Focus

Three facilities have been identified as the primary odor emitters of concern based on reviews of the BAAQMD and South Bay community's odor complaint logs and historical records: The NIRRP, the San José-Santa Clara RWF, and the ZWED facility (Figure 1-1). They are located in close proximity to one another, typically upwind of the impacted South Bay communities during seasonal and/or operational periods that have the highest potential for odor impacts, and their odor emissions are often mixed together before reaching the receptors. This Study and its three planned odor sampling events are focused on these three facilities to assist BAAQMD in determining if these facilities are or can routinely impacting the South Bay communities with odor emissions (individually or combined) above odor nuisance levels.



Figure 1-1. Key Odor-Emitting Facilities and Surrounding Communities

All three facilities emit several common odorants (including ammonia, hydrogen sulfide, reduced sulfur compounds, amines, and other biological and chemical based odorants), and “facility unique” odorants. In addition to off-site wastes, the three facilities also receive, process, and discharge waste streams to and from each other, as illustrated on Figure 1-2. For example, stabilized and dried biosolids from the RWF is transported

in late summer or early fall and stockpiled at the NISL for use as alternate daily cover for landfill operations. NISL leachate is delivered to the RWF for treatment. Green waste and food waste are delivered to the NIRRP composting area. The non-biodegradable waste, or “overs”, from the ZWED operation is transported to Newby Island.

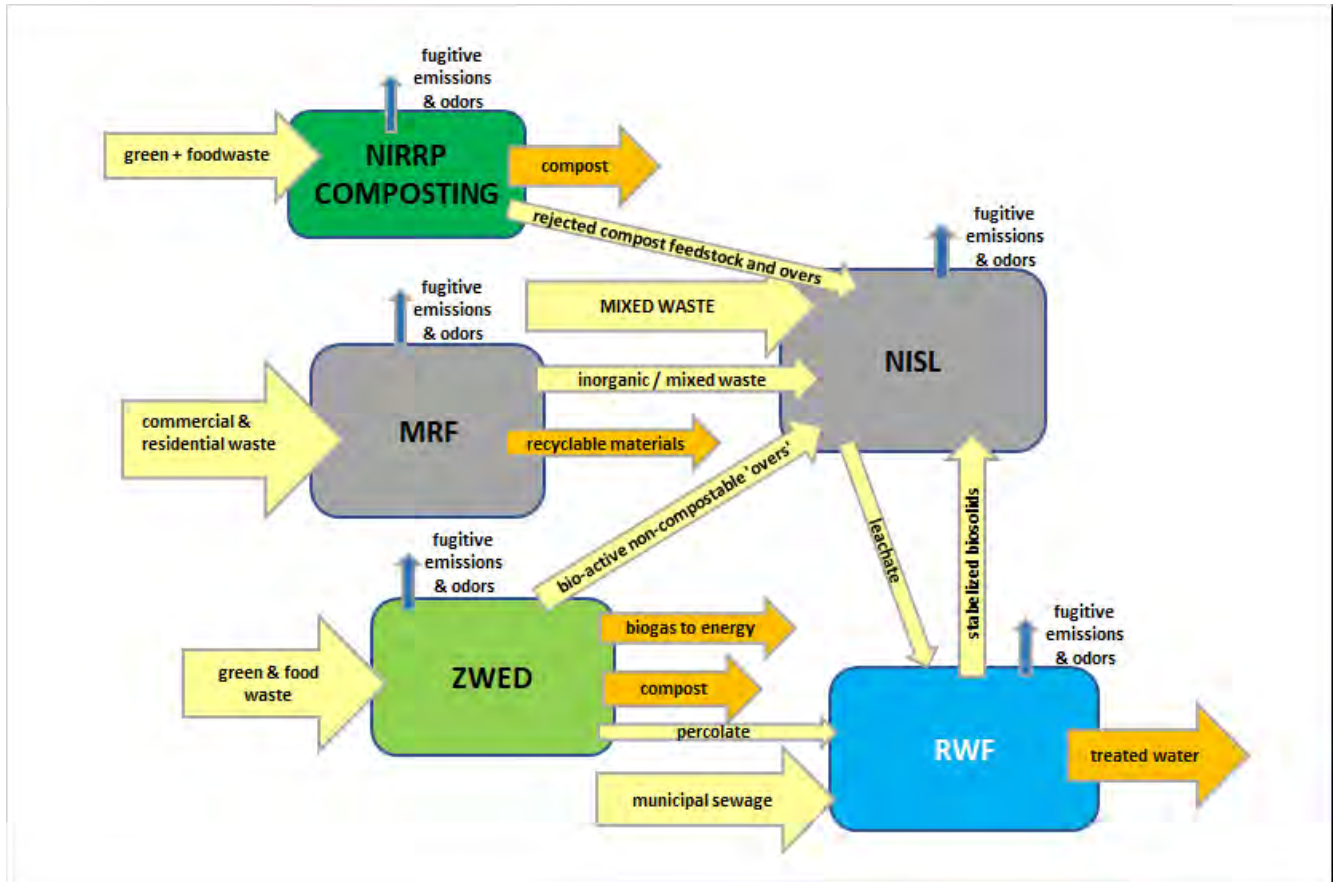

Figure 1-2. Facility Interactions

The subsequent sections provide a general description of each facility, process overview, and summary of potential odor sources.

### 1.3.1 Newby Island Resource Recovery Park

The NIRRP is operated by Republic Services, Inc. The facility consists of the NISL, MRF, and a covered aerated static pile (ASP) organics composting facility. It is located on the northern boundary of the City of San José, with Milpitas generally located to the east (Figure 1-1). The Fremont industrial area lies immediately north and northeast of the facility boundary, with Fremont residential areas located further to the north and east. The main residential areas of San José and Santa Clara are to the south and southwest of the facility, respectively.

The facility accepts and processes a wide variety of municipal, recyclable, and industrial waste from the surrounding communities. These wastes can include green waste, limited food waste (such as spoiled milk solids and other food waste comingled with green waste delivered to the composting facility), commercial waste, residential waste, and biosolids material. According to Newby Island staff (site visit, June 25, 2020), overall the amount of waste currently received is 13.9 percent lower than pre-COVID-19 (prior to business closures and travel restrictions resulting from local shelter-in-place orders that went into effect in mid-March 2020). Profiled

waste such as sludge and soils have returned to pre-COVID-19 levels. Municipal solid waste (MSW) is down 9 percent while other types also remain slightly down from pre-COVID-19 levels.

There are six process areas for processing the wastes entering the facility: MRF, working face of the landfill, green waste receiving and grinding area, composting area, biosolids stockpiling area, and the landfill gas collection area (Figure 1-3). Typically, the wastes enter the facility from the east via trucks and are dumped at various locations throughout the site for further processing, depending upon the types of waste.

The NIRRP has eight odor neutralizing systems placed strategically onsite. Each system consists of multiple nozzles. The system serving the fence line is approximately 1,300 feet in length. When biosolids are delivered in October, the NIRRP rents a large misting system. Misting is operated until 11:00 pm at landfill locations. All others are operated 24 hours.

Gas systems and liquids systems are operated 24 hours per day, seven days per week while the working face is open until 11:00 pm.



Figure 1-3. Newby Island Resource Recovery Park Facility Map, Milpitas, California (source: Google Earth)

### 1.3.1.1 MRF

Of the six process areas, the MRF is located closest to Milpitas and Fremont industrial and residential areas. Located at the southeast portion of NIRRP near the main entrance (Figure 1-3), the MRF at Newby Island is an advanced recycling facility with four processing lines designed to process 400,000 tons per year and allows Republic Services to sort through inorganics and recyclables to divert as much material as possible from the landfill. The MRF is operated daily from 3:00 a.m. to 11:00 p.m. No deliveries occur on Sundays and only two

shifts are operated on Saturdays. Unsorted materials are often left overnight outside of the west side doors 1 and 3 due to overflowing or equipment breakdown. Furthermore, some sorted materials on bale are stockpiled at the southeast section of the facility.

The MRF consists of receiving bays in a partially enclosed but ventilated building. The MRF is not considered to be a fully enclosed operation due to the building openings and the fact that the doors are typically open. Selected commercial and residential waste trucks dump their waste at the receiving bays at the west end of the MRF building. The waste is then moved via conveyors throughout the building, where recyclable material is manually separated from the waste and then sent for recycling. The separated waste is loaded onto trucks for disposal at the landfill portion of the facility. If there is insufficient space within the building to contain the material, unprocessed waste is often placed at the edge of the receiving bay or outside the building during the day.

Previously, biodegradable waste was separated from the streams and loaded into trucks for off-site delivery to the ZWED facility for further biodegradation to develop biomass fuel for energy generation. As of May 2020, the food waste is no longer received at the MRF, but rather sent directly to the ZWED facility for processing. This operational change reportedly has significantly reduced odors at the MRF, and significant odors were not observed there during the site visit on June 25, 2020.

At several locations within the MRF building, odorous air is collected via ventilation systems and transported to baghouses outside the building for control of particulate matter prior to emission into the atmosphere. According to MRF staff (site visit, June 25, 2020), the baghouse systems and exhaust fans are not typically operated; rolling doors are left open for ventilation instead. Odorous air not ventilated to the bag houses (from receiving bays) escapes without treatment from the open doors as fugitive emissions.



Figure 1-4. MRF Sorting Area

### 1.3.1.2 Landfill Working Face

The NISL is one of the largest active landfills in the Bay Area, occupying approximately 340 acres. It is located at 1601 Dixon Landing Road, north of the RWF lagoons and west of Interstate 880. The landfill is an island surrounded by a levee that keeps its runoff from directly entering the San Francisco Bay.

The landfill provides waste disposal and on-site natural gas fueling services. The compressed natural gas (CNG) refueling station fuel is sourced externally since the NISL does not have a system that extracts landfill gas and injects it into the CNG pipeline. Approximately 350 to 500 trucks deliver waste to the facility each day on average, with truck deliveries as high as 750 to 800 per day between April 15 and October 15. Based on interviews with Newby Island staff during the site visit on June 25, 2020, the landfill is estimated to have 14 more years of space assuming current fill rate and population growth (Note: this is only a stated estimate, no data was provided). The leachate that drains from the landfill is treated in the neighboring RWF. Interim daily cover, such as soil or dried biosolids from the RWF, is applied over the received waste to minimize odorous emissions to the atmosphere.

Waste dumping at the landfill working face includes four main waste streams: (1) general garbage (off-site commercial and residential waste) delivered by trucks; (2) waste from the MRF area; (3) the nonbiodegradable waste ("overs") from the ZWED operation delivered by trucks, and (4) rejected loads from the onsite composting operation which contain too much contamination for compost feedstock. Based on site observations at the working face, dumping of ZWED waste appeared to have the greatest potential for short-term odor emission generation compared with other waste loads dumped at the working face. This observation has been recognized by the landfill operating staff and, as such, the landfill reportedly receives ZWED waste only between 6:00 a.m. and 10:00 a.m. and the dumped material is immediately covered with soil or other non-odorous waste to minimize odor emissions. Also, grit and screenings from the nearby RWF are also observed to be odorous sources. In addition to the four main waste streams, milk solids (spoiled) also are periodically delivered to the working face from Beverly Farms; this waste can be odorous.

### **1.3.1.3 Green Waste Receiving and Grinding Area**

The green waste facility is an open area process where green waste is ground into more unified sizing and comingled with food waste for effective composting. The facility is located in the southwest corner of NIRRP, adjacent to the composting process. Green waste received at Newby Island consists primarily of residential garden waste, but also includes up to 10 percent commercial green waste by volume.

The facility includes an unloading area where trucks dump green waste into a stockpile area for fresh green waste. Figure 1-5 shows trucks dumping green waste into the stockpile area and grinders, and a corner of the adjacent compost process to the east. Front-end loaders transport the fresh green waste (bulking agent) into the grinder; the ground green waste is then moved with front-end loaders into ground green waste stockpiles mixed with food waste to await transport to the composting area. Stockpile size is generally 100 feet by 30 feet by 15 feet tall. However, size can vary based on productivity. Due to the nature of the material and the grinding operation that allows greater surface area of the waste to be exposed, odors are emitted from this process. The green waste facility was previously moved to its current new location, resulting in fewer complaints. This source is therefore considered a lower priority source for the first sampling event.





Figure 1-5. Newby Island Landfill Green Waste Facility

#### 1.3.1.4 Composting Area

Ground green waste comingled with food waste is transported to the composting area and the material is placed into bunkers and aerated for natural biodegradation or composting. According to NISL staff, the material sits in these bunkers for 28 to 30 days before the material is removed and sent to curing.

In order to minimize odor generation from this process, the ASPs are provided with two feet of biolayer on top of the 6-foot tall pile and irrigated. This layer acts as a biofilter for biodegradation of odors emitted. There are four bunkers each sized at 360 feet by 120 feet. Pile height is 8 feet (6 feet of compost media and 2 feet of biolayer). Each bunker has one blower which produces 12,000 standard cubic feet per minute (scfm) of air per bunker. This process air is delivered to one of three pile groups for 15 minutes and then sequentially delivered to the next pile group. Each pile group consists of four piles such that the instantaneous aeration area size is 30 feet by 120 feet (14,400 square feet). Therefore, the loading rate when aerated is  $12,000 \text{ scfm} / 14,400 \text{ square feet} = 0.83 \text{ feet per minute (fpm)}$ ; or  $12,000 \text{ scfm} / 3,200 \text{ cubic yard (CY)} = 3.75 \text{ scfm/CY}$ . The irrigation is cycled at 6-minute intervals. Compost media moisture content is targeted for 50 percent. Figure 1-6 shows the northwest-most bank.

After composting, the green waste is sent to the curing piles. Composted material is transported to long rows known as windrows and remain there for four weeks. Each curing pile is sized for 180 feet by 12 feet by 7 feet tall. However, pile amount can vary based on operational activities, but up to 20 cure piles at one time are possible. Agitated curing piles are believed to be a source of odors. After the curing piles, the material is screened and then sits for up to two weeks as finished compost material. Finished pile size is 160 feet by 30 feet by 18 feet tall. However, pile size can vary based on demand.



Figure 1-6. Newby Island Landfill Composting Process

#### 1.3.1.5 Biosolids Stockpiling Area

Air-dried biosolids from the RWF are trucked to the facility and deposited in the biosolids stockpiling area. The biosolids are used as alternative daily cover on the working face and are spread evenly for land contouring. The hauling and stockpile operations occurs for a short period each year, typically during October, and material is moved typically in the mornings. After this annual operation is completed, the biosolids stockpile area is covered. The following odor mitigation activities are incorporated into this process:

- Neutralizer/misting surfactant sprayed locally at night;
- The dried biosolids are kept wet during the day; and
- On Friday afternoons, the dried biosolids are covered with a biofilter material.

### 1.3.1.6 Landfill Gas Collection System

This system applies a vacuum on hundreds of installed collection wells to collect subsurface landfill gas and transports it to a gas flare header system for combustion by two flares (Figure 1-7). While landfill gas is intended to be contained within the collection and conveyance process, insufficient header sizes cause back-pressure issues and allow fugitive odors to escape. During a site visit conducted on June 25, 2020, strong landfill gas odors were observed along the east slope of the working face. During the site visit, NISL staff indicated that a new landfill gas (biogas) improvements project is currently underway. In the interim, 100 collection wells were installed during 2015 to prevent bottlenecks and subsequent fugitive landfill gas leakage and fugitive odors. The new improvements project includes upsizing gas headers and proper sloping and condensate control to reduce gaseous emissions from the landfill. Even so, biogas can still be emitted from the landfill. Strong landfill odors were detected at specific on-site locations during the site visit. Newby Island staff indicated that some of the header sizes of the gas collection system are being upgraded as there are currently still bottle necks creating some fugitive landfill gas odors.



Figure 1-7. Landfill Gas Header

The NISL has observed a spike in hydrogen sulfide content in their landfill gas this year with reported exceedances of the total reduced sulfur (TRS) 300 parts per million by volume (ppmV) quarterly limit for the first two quarters this year (as high as 500 ppmV). This increase may be a result of accepting fire debris resulting from California wildfires and subsequent home reconstruction debris, from sludge, or from construction/demolition debris which got wet from rainfall while exposed.

NISL completes Surface Emission Monitoring (SEM) Surveys quarterly. NISL is subject to the state methane rule, including monitoring.

### 1.3.1.7 Leachate Collection System

Leachate from the landfill can be odorous. The site maintains a liquid management system that utilizes approximately 126 pneumatic and electric pumps throughout the site. Liquid from the waste mass is pumped through a force main of HDPE pipe into a series of sealed tanks, where modest vacuum is applied. Liquids contained within the sealed tanks are transferred to the RWF for processing; at present the transfer is performed with a tractor-trailer (tanker). NISL works with a third-party contractor to perform routine cleaning of the FM lines; this process occurs semi-annually or more frequently if necessary. During normal operation, there are minimal odor emissions. The liquids management system is sealed and stored liquids remain sealed and under modest vacuum. Liquids are transferred to the RWF, Monday through Friday, during regular operating hours. Typically, 12 to 16 truckloads is the maximum number transferred to the RWF, with the average being six truckloads per day.

Table 1-1 summarizes a list of key potential odor sources and expected key odorant groupings associated with NIRRP.

Table 1-1. Key Potential Odor Sources and Expected Odorant Groupings for NIRRP

Key Potential Odor Sources	Preliminary List of Key Odorants <sup>a</sup>
MRF	<ul style="list-style-type: none"> <li>▪ Reduced sulfur compounds</li> <li>▪ Amines</li> <li>▪ Volatile organic compounds (VOCs)</li> </ul>
Newby Island Landfill	<ul style="list-style-type: none"> <li>▪ Reduced sulfur compounds</li> <li>▪ Amines</li> <li>▪ VOCs</li> <li>▪ Aldehydes</li> <li>▪ Carboxylic acids</li> </ul>
Landfill Biogas Collection	<ul style="list-style-type: none"> <li>▪ Reduced sulfur compounds</li> <li>▪ Amines</li> <li>▪ VOCs</li> <li>▪ Aldehydes</li> <li>▪ Carboxylic acids</li> </ul>
Composting Facility	<ul style="list-style-type: none"> <li>▪ Reduced sulfur compounds</li> <li>▪ Ammonia</li> <li>▪ Amines</li> <li>▪ VOCs</li> <li>▪ Aldehydes</li> <li>▪ Carboxylic acids</li> </ul>

<sup>a</sup> List of expected odorants is corroborated and supported via literature and past experience.

### 1.3.2 San José-Santa Clara Regional Wastewater Facility

The RWF is located in the City of San José at 700 Los Esteros Road. It is a tertiary publicly owned wastewater treatment plant, which includes pretreatment, primary treatment, sludge digestion, secondary treatment, and tertiary treatment. Furthermore, key unit processes are identified that represent potential odor emissions. Built in 1956 and expanded several times since, the RWF treats an average of 110 million gallons per day (mgd) of wastewater and has the design capacity to treat 167 mgd. It is jointly owned by the cities of San José and Santa Clara and is managed and operated by the City of San José’s Environmental Services Department. The RFW also serves several tributary cities or agencies including Milpitas and Fremont. Figure 1-8 illustrates the overall RWF site plan excluding lagoons and sludge drying beds.

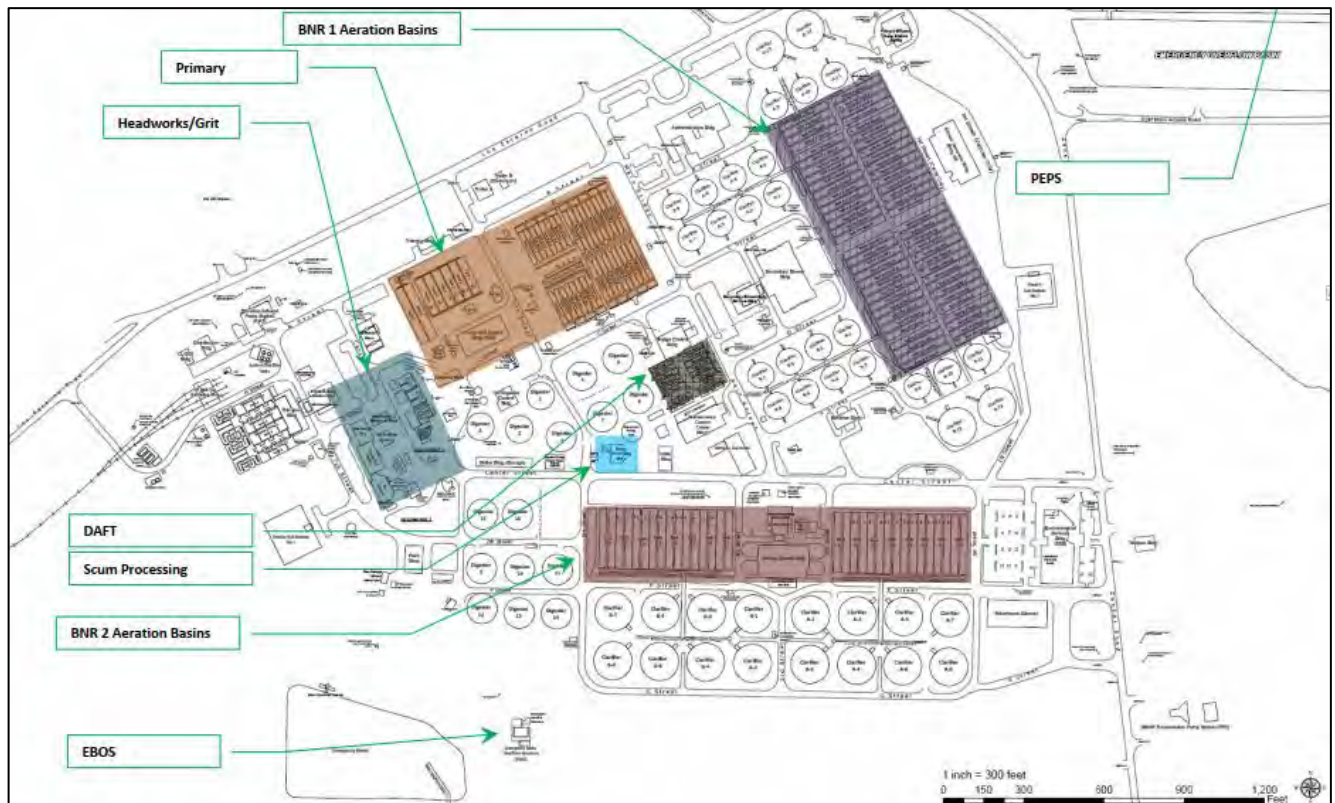

Figure 1-8. San José-Santa Clara RWF Overview (CH2M Hill 2012)

The RWF is located on 2,600 acres along the southern shoreline of the San Francisco Bay and includes a 175-acre wastewater processing area, a 750-acre sludge-drying area, and an 850-acre former salt production pond that has been restored to a tidal marsh. The remaining acreage is open land that buffers adjacent communities from RWF operations. The RWF 10-year \$1.4 billion capital improvements project began in 2014. Key upgrades include sludge digestion process, piping, structural improvements, a new flare, construction of a third headworks facility, dissolved air flotation thickener (DAFT) improvements, new cogeneration facilities, and a sludge dewatering facility.

Jacobs (previously CH2M Hill) completed a comprehensive Odor and Corrosion Study in 2015 in which three separate sampling events were completed along with ambient monitoring. Findings from that work, along with a recent site visit, are used to inform the basis for statements made in this Plan related to odor potential and proposed sampling locations at this facility.

Based on feedback from RWF staff, there have been minimal impacts on total volume of wastewater received at the RWF compared to pre-COVID-19 levels. While the influent flow hasn't changed significantly since the shelter-in-place order was implemented, the daily peak flow occurs a bit later in the day. These changes have not affected operations.

Wastewater entering the RWF is divided into two key treatment processes: liquid treatment and solid treatment, each having unique odor characteristics.

### 1.3.2.1 Liquid Treatment

Preliminary treatment occurs at the headworks facility and includes screening and grit removal. Screens remove debris such as sticks, rocks, trash, and rags with finer screens removing organics and smaller inorganics. Screened wastewater flows into aerated grit chambers where sand and gravel are removed. Material removed from

preliminary treatment including dewatered grit and screenings is trucked to the NISL. Preliminary treatment is not contained or treated. A comprehensive Odor and Corrosion Control Study (CH2M, 2015) was completed to characterize odor emissions and offsite impacts from the RWF. This study demonstrated that while the headworks are odorous, the actual impacts are relatively minor in terms of offsite effects beyond the fence line. This is mainly due to partial containment as well as distance away from fence line, coupled with prevailing wind conditions. Therefore, this source is considered a lower priority source and is not included herein as a source to be sampled.

Primary treatment of wastewater coming in from the grit chambers occurs in rectangular primary clarifiers which include an inlet channel, quiescent zone, effluent launder, and outlet channel. The clarifier facility is comprised of several open rectangular tanks, which combined account for just under four acres of space. The east primary clarifiers are located on the northern edge of the RWF, roughly 250 feet south of Los Esteros Road (Figure 1-9). Fiberglass bars, or flights, rotate to skim off fats, oils, and grease from the surface of the water and to scrape solids that sink to the bottom. The large area combined with the lack of odor control and generally odorous process creates the potential for significant odor emissions.

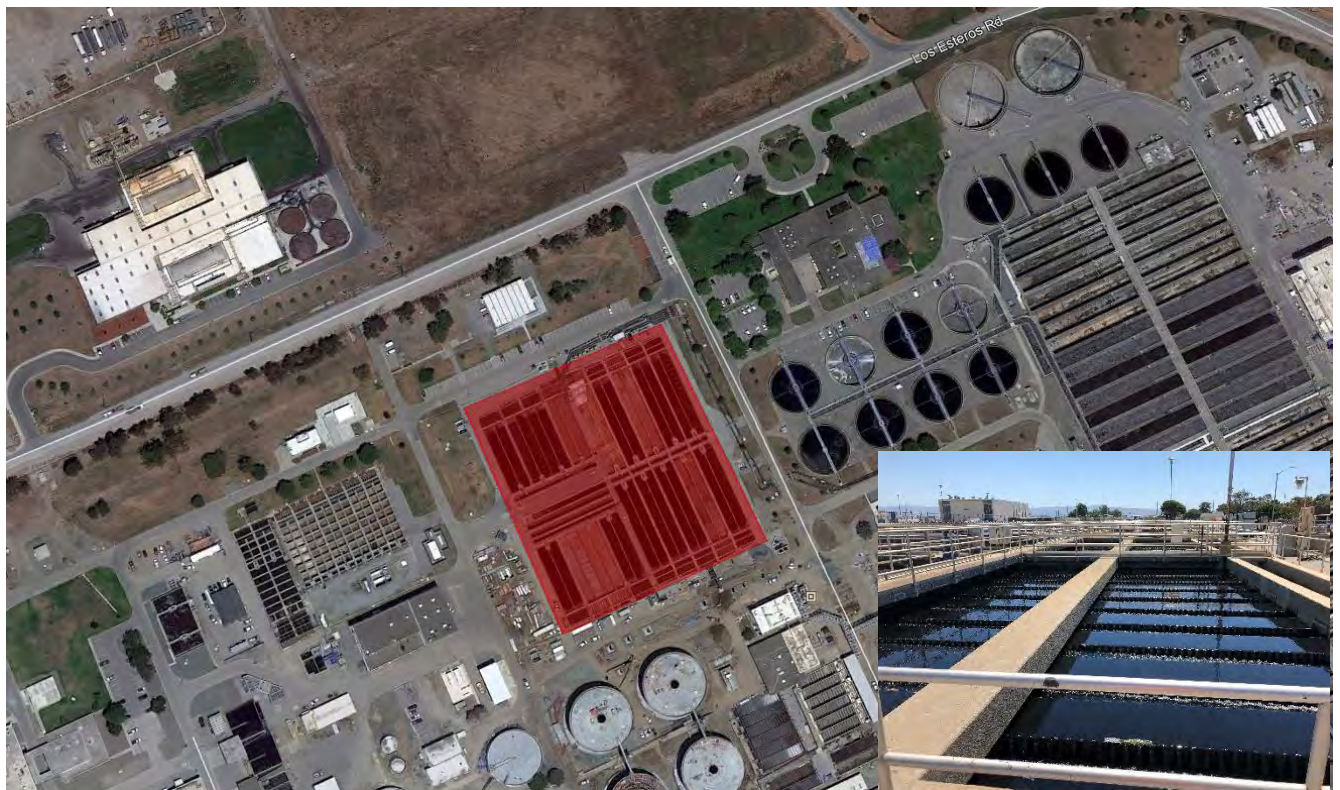

Figure 1-9. RWF East Primary Tanks (Effluent Launders Inset)

Secondary treatment of wastewater entering from primary clarifiers consists of aeration (for biological nutrient removal [BNR]) and secondary sedimentation. Aerated wastewater is piped into secondary clarifiers from where the clarified water proceeds on for tertiary treatment and the settled sludge is transferred to digesters or recirculated back to the aeration tanks. RWF operates two BNR systems: one is located in the northeast corner of the facility and the other is located on the southern edge of the facility. Both BNR systems are comprised of several open aeration tanks and clarifiers, occupying a combined area of roughly 40 acres. The BNR systems have both anoxic and aerobic zones associated with the process; Figure 1-10 shows the BNR process during aeration. Similar to the east primary clarifiers, the large area and generally odorous process creates the potential for

off-site odors impact. Based on odor sampling completed by Jacobs (previously CH2M Hill) in 2012, both facilities exhibit similar odors with the most significant odor coming from the anoxic zone of each facility (CH2M Hill 2012).

Tertiary treatment consists of filtration and chlorination. Secondary treated wastewater flows through several filter beds composed of gravel, sand, and anthracite coal to remove small suspended solids and then through serpentine tanks where chlorine is used to kill any remaining viruses or bacteria.

After tertiary treatment, about 80 percent of the treated water is piped to the outfall channel. From here, it flows to Artesian Slough, through Coyote Creek, and eventually into San Francisco Bay. The remaining 20 percent of the treated water is sent to South Bay Water Recycling and is used to irrigate food crops, parks, schools, golf courses, street medians, and business park landscaping.

### 1.3.2.2 Solids Treatment

Solids collected from various stages of liquid treatment undergo further processing in flotation thickeners, digesters, lagoons, and drying beds. Settled sludge from secondary clarifiers is taken to dissolved air flotation thickeners, where air is pumped into the sludge to break it down further into solids and water. Water is returned to the primary clarifiers for further processing.

The sludge from thickeners, along with settled sludge from primary clarifiers and filter beds is collected in digester tanks. In these tanks, anaerobic bacteria digest the sludge and produce the biogas, which is used for cogeneration (or flared, which is only used when necessary). Based on currently available information, biogas sources at the RWF are considered to be lower priority sources due to predicted smaller plumes and infrequent expected releases. There have been reports of the RWF intentionally venting biogas due to construction activities, but it is believed that this practice is not likely to continue once the new Cogen Plant is operational and once the Digester Improvements project is completed.

Digested sludge is pumped into lagoons to stabilize and is covered with water to control the odors (Figure 1-11). These pipes discharge above the water surface and can be very odorous. This process lasts approximately 10 minutes when pumping occurs. This source will be further investigated in case additional sampling is required for characterizing this source during a pumping event. The overall lagoon system is comprised of several large lagoons, which occupy a total area of roughly 200 acres. The lagoons are located northeast of the main RWF processes, adjacent to the southern portion of the San Francisco Bay and just south of the



Figure 1-10. RWF BNR Process



Figure 1-11. RWF Lagoons

NISL. Lagoon characteristics vary depending on the age of the sludge. Lagoons with recently added sludge tend to have a small water cap and are generally more mixed, allowing for odor emissions from the sludge to escape. Lagoons that have settled tend to have a thicker water cap and allowing for more control of odors. This sludge is moved to the drying beds to be air-dried after a 5-year stabilization process. This step produces high-quality Class A biosolids which are subsequently used as daily cover at NISL.

Once sludge has settled in the lagoons, roughly a 5-year process, the material is then dredged and placed in drying beds. The sludge-drying beds are located adjacent to the lagoons and occupy roughly 100 acres. Dredged sludge fills the basins and is left to dry until October when the sludge is removed and hauled to the NISL. According to RWF staff, the disturbance of the sludge can create an odorous situation.

The RWF will be undertaking a project to remove old biosolids, approximately 157,000 cubic yards, from lagoons that had been historically used by the facility and transported to a nearby location where they will be capped and stabilized. According to RWF staff, these legacy biosolids lagoons are over 30 years old. Legacy lagoons are entirely separate from the active lagoons and are jurisdictional wetlands since they weren't maintained. The solids may be hazardous waste. Due to their age, it is not anticipated that these activities will have a significant odor emission; however, some odor may potentially be generated during the biosolids relocation process. This project is anticipated to begin in August 2020 and conclude in December 2020.

Table 1-2 summarizes a list of key potential odor sources and expected key odorant groupings associated with the RWF.

Table 1-2. Key Potential Odor Sources and Expected Odorant Groupings for RWF

Key Potential Odor Sources	Preliminary List of Key Odorants <sup>a</sup>
Primary Clarifiers	<ul style="list-style-type: none"> <li>▪ Reduced sulfur compounds</li> <li>▪ VOCs</li> <li>▪ Carboxylic acids</li> <li>▪ Fecal odorants</li> </ul>
Lagoons	<ul style="list-style-type: none"> <li>▪ Reduced sulfur compounds</li> <li>▪ Ammonia</li> <li>▪ Amines</li> <li>▪ VOCs</li> <li>▪ Aldehydes</li> <li>▪ Carboxylic acids</li> <li>▪ Earthy/musty odorants</li> </ul>
Biosolids Cake Drying Beds	<ul style="list-style-type: none"> <li>▪ Reduced sulfur compounds</li> <li>▪ Ammonia</li> <li>▪ Amines</li> <li>▪ VOCs</li> <li>▪ Aldehydes</li> <li>▪ Carboxylic acids</li> </ul>

<sup>a</sup> List of expected odorants is corroborated and supported via literature and past experience.

### 1.3.3 Zero Waste Energy Development Facility

ZWED is a dry fermentation anaerobic digestion (AD) facility located in the City of San José at 685 Los Esteros Road (Figure 1-12) that produces clean, green renewable energy, while simultaneously producing a feedstock for composting. At approximately 41 acres in area, it is the first large-scale commercial dry fermentation AD technology in the United States and is the largest facility of its kind in the world. The facility processes an estimated 90,000 tons per year of “wet” organic waste material that is collected primarily from commercial



industries, and includes food waste and residential waste (mainly yard trimmings), that would otherwise go to landfill. The facility is primarily contained within a single building where sorting, digestion and composting occur.

ZWED sources organic waste (feedstock) from the City of San José and surrounding communities and converts it into biogas through controlled anaerobic conversion of organic materials in large airtight containers (digesters). The biogas is stored onsite and used to power two on-site combined heat and power (CHP) engines. The main steps in the ZWED process are shown in Figure 1-13. As of May 2020, material is delivered directly to ZWED instead of first being sorted at the Newby Island MRF. At the beginning of the shelter-in-place orders implemented in mid-March 2020 in response to the COVID-19 global pandemic, incoming feedstock slowed to almost nothing. At present, incoming feedstock is approximately 50 percent of normal.

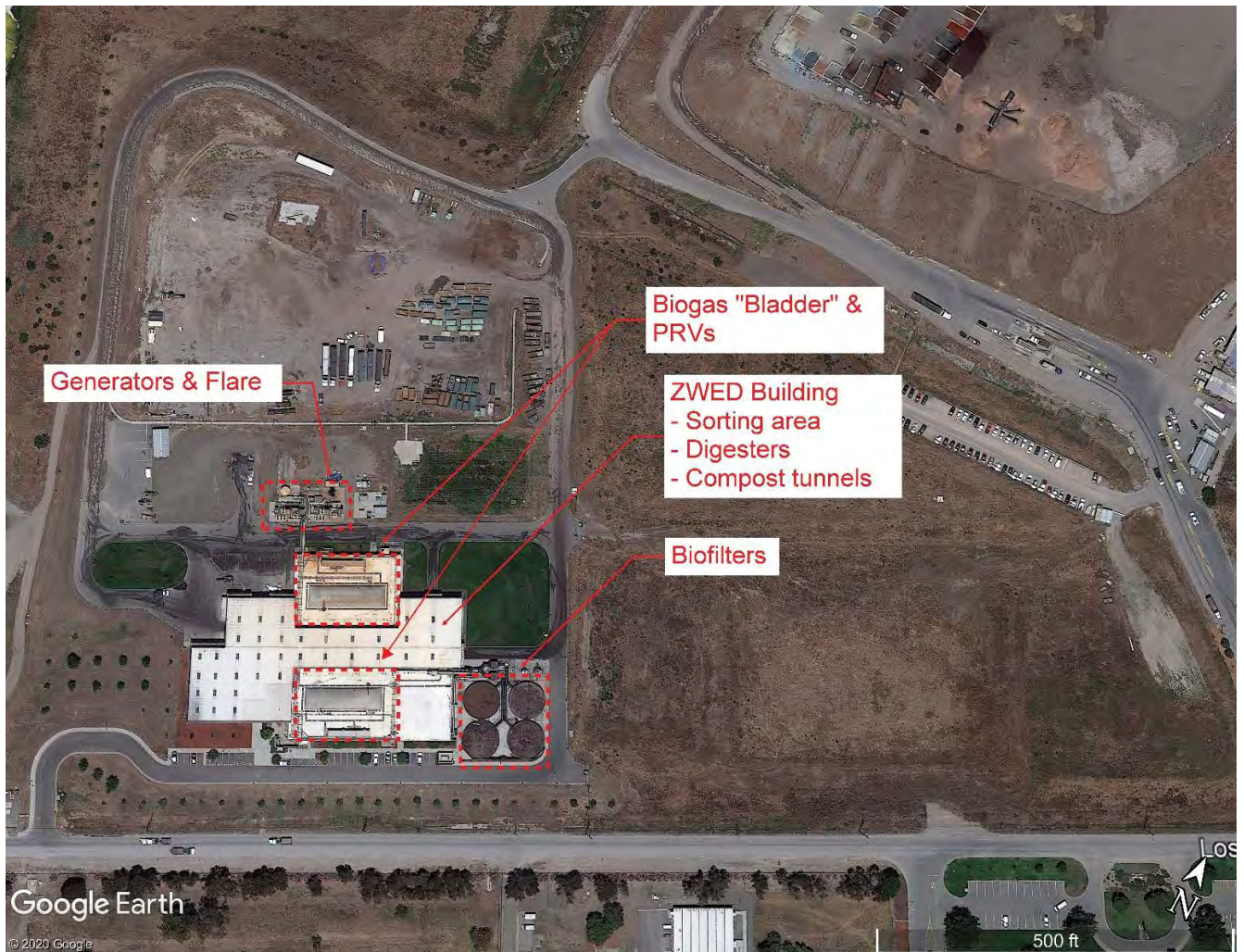

Figure 1-12. ZWED Facility Overview

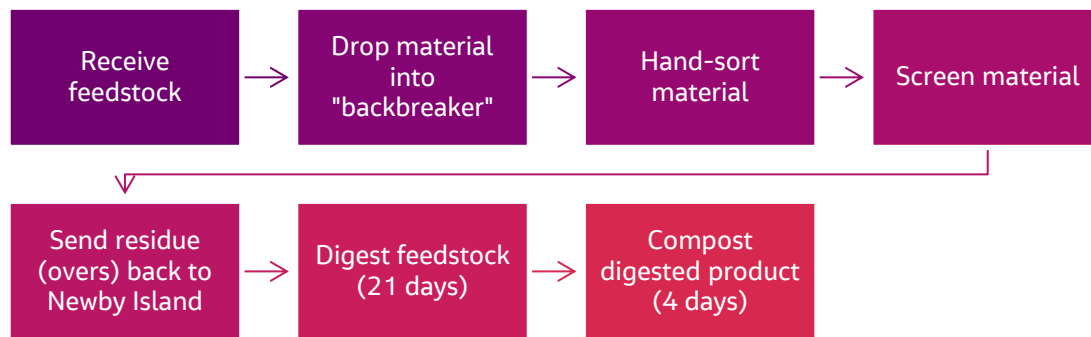

Figure 1-13. ZWED Basic Process Steps

Approximate feedstock source and percent breakdown is as follows:

- San José; 60 percent by volume. Mostly commercial (Safeway, restaurants).
- Sunnyvale: 10 percent by volume.
- Palo Alto: 10 percent by volume. Residential/commercial (residential is mostly green waste).
- Mountain View: 10 percent by volume.
- Other: 10 percent by volume.

The facility exhibits seasonal variations due to changes in feedstock. For example, ZWED receives more fruit in the summer and more pumpkin in October. Methane generation is greatest in the summer and slows down in the winter.

Approximately 20 to 25 trucks deliver feedstock to the facility daily. Approximately nine to ten trucks leave with finished product daily. Trucks are covered to contain odors. Only three to four trucks deliver on Saturdays, while there are no deliveries on Sundays. Material is delivered to the facility between 3:00 a.m. and 4:00 p.m. daily, but most deliveries are in the morning between 6:00 a.m. and noon. All material is processed by the end of the day (no more than nine hours total on site). Facility doors are only opened when trucks deliver or leave. On the day of the site visit, ambient odors around the facility were observed to be mild to moderate.

The sorting process and digesters are contained within the main building (Figure 1-14). Inside the building there are piles of sorted and unsorted waste, which create a humid and odorous air condition. In addition, digesters are housed within vessels which are closed during digestion but opened when new material is brought in or old material is transferred to the composting vessel, further adding to the odor concentration in the building. An open digester is shown below on Figure 1-15. When trucks are coming in or leaving the facility, large roll-up doors are opened, allowing fugitive odors to escape from the building.



Figure 1-14. ZWED Interior Sorting Area



Figure 1-15. ZWED Open Digester

A total of 16 anaerobic digesters are utilized and split into two modules (or trains). In addition, two percolate tanks are provided (one for each module/train). The percolate tanks house the bacteria used for digester fermentation. Within the digesters, lipids, carbohydrates, and proteins are converted to acids that are further broken down into micronutrients. Three fermentation levels are implemented as part of the digestion process as follows:

- Fermentation Level A: 4 to 6 minutes spray with percolate
- Fermentation Level B: Most aggressive
- Fermentation Level C: Taper off

Biogas produced by the digestion process is stored in a bladder-type gas holder consisting of an inner flexible membrane and outer flexible membrane. The pressure within the gas holder is controlled by modulating the pressure within the interstitial space. This requires that the space “breathes”, thereby controlling pressure as the gas holder fills and is depleted throughout the day. Air released from the interstitial space is treated in a small carbon unit mounted on the roof. On the day of the site visit (June 2020), the air emitted from this unit was observed to be moderately odorous. ZWED staff indicated that the carbon media is changed out every six months. Each digester, percolate tank, and the biogas holder are provided with a pressure relief valve (PRV). On the day of the site visit, one of the percolate tank PRVs was observed to be leaky with moderate odors observed.

Previously, regular PRV releases were occurring at the biogas bladders. Changing the PRV and flare setpoints appeared to eliminate most of those releases. The 400,000-gallon percolate tank is discharged directly to the RWF.

The biogas powers two 800-kilowatt on-site CHP engines driving electric power generators. In a good year they generate 1.1 to 1.4 megawatts per hour. Heat extracted from the hot combustion exhaust of each engine is used to warm the AD process. A flare is included as backup to combust the biogas when insufficient engine capacity is available due to maintenance or other downtime of the engines. In addition, the flare is used during digester shutdown in which de-gassing biogas is fed to the flare when methane content drops to 20 percent or less. The flare is used every day except Sundays. An iron sponge followed by activated carbon is utilized for scrubbing the biogas of hydrogen sulfide. Siloxane was an issue in the past but not presently. No siloxane removal is provided.

Green waste is added to the feedstock to add structure and surface area. The green waste does not generate the same level of biogas as the organics and the added material reduces H<sub>2</sub>S formation. After the digestion phase is complete (up to 21 days), the remaining material is removed from the digesters and placed into in-vessel composters (IVC) tunnels inside the same building (for up to four days), which reduces moisture content and thereby reduces hauling costs. The material is then removed from the IVC tunnels and transported to a facility in Gilroy, which further processes the material for sale as soil amendment.

The facility operates a 4-cell biofilter system for treating 70,620 cubic feet per minute (cfm) air from the main ZWED facility interior space and IVC tunnels. This system consists of crossflow ammonia acid scrubbers (2), at-grade organic media biofilters (4), in-line fans, and associated ducting and controls. Permit conditions require that ammonia scrubber pH be maintained between 1.5 and 4.0, that biofilter media moisture content be maintained within an acceptable range of 40-80 percent, and that pressure/flow be monitored for each biofilter cell.

Foul air from the interior of the building and from the composting process is conveyed to four circular biofilters located on the southwest corner of the facility. In addition, prior to emptying a digester, the digester is degassed by sending foul air to the biofilters. Foul air is treated via an ammonia scrubber before being sent to the biofilter then exhausted out the open top of the units. Figure 1-16 shows the top of the most southwest biofilter, which is comprised of organic media.



Figure 1-16. ZWED Biofilter

Engines are equipped with emissions controls. The flare may be considered an odor source. The biofilter permit provides limits for ammonia, H<sub>2</sub>S, and precursor organic compounds. An odor misting system installed around the biofilters is no longer used.

Table 1-3 shows the key potential odor sources and expected key odorant groupings associated with the ZWED.

Table 1-3. Key Potential Odor Sources and Expected Odorant Groupings for ZWED

List of Key Potential Odor Sources	Preliminary List of Key Odorants <sup>a</sup>
Interior Space	<ul style="list-style-type: none"> <li>▪ Reduced sulfur compounds</li> <li>▪ Ammonia</li> <li>▪ Amines</li> <li>▪ VOCs</li> <li>▪ Aldehydes</li> <li>▪ Carboxylic acids</li> </ul>
Biofilters	<ul style="list-style-type: none"> <li>▪ Reduced sulfur compounds</li> <li>▪ VOCs</li> </ul>
Biogas holder and Percolate Tank PRVs	<ul style="list-style-type: none"> <li>▪ Reduced sulfur compounds</li> <li>▪ Amines</li> <li>▪ VOCs</li> <li>▪ Aldehydes</li> <li>▪ Carboxylic acids</li> </ul>

<sup>a</sup> List of expected odorants is corroborated and supported via literature and past experience.

### 1.4 Description of Receptor Areas

As previously described, the community of Milpitas has been adversely affected by fugitive odor in the area due to its position southwest of the potential odor sources, which is downwind of the prevailing wind direction. Figure 1-17 shows a summary of complaints plotted by approximate location within the Milpitas area. These initial odor complaint records ranged from September 2012 to September 2015 when 3,412 complaints were logged by BAAQMD. Complaint data is based on block data and no real addresses or names are reflected in the data.

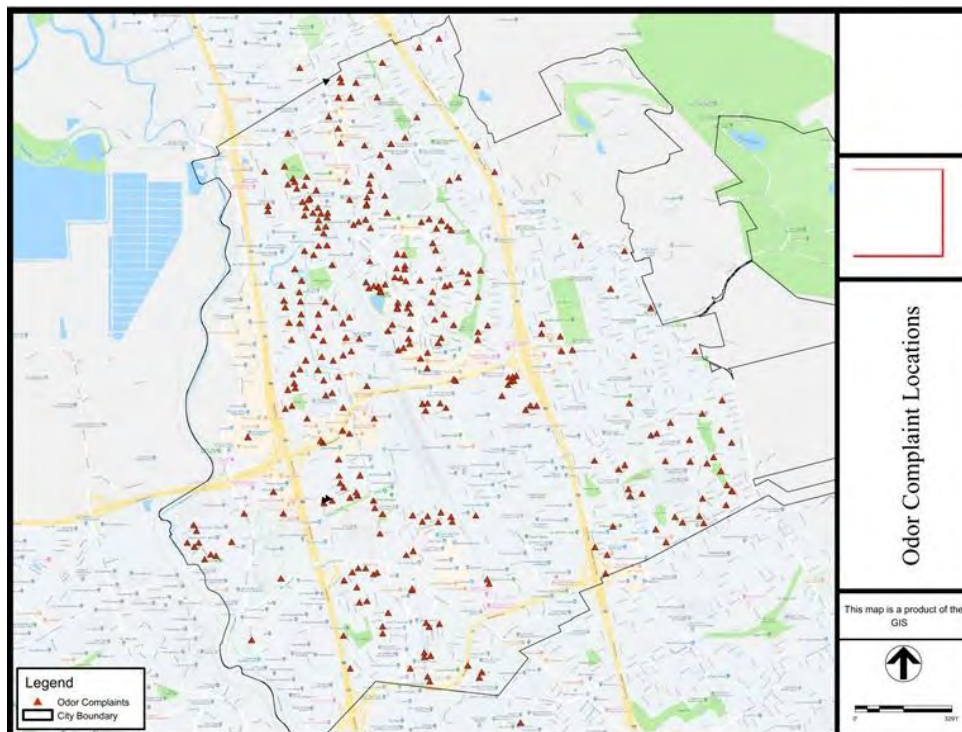

Figure 1-17. Milpitas Historical Complaint Locations (2012 to 2015)

To provide context on how this compares to other communities: between December 2014 and March 2016, 4,810 odor complaints were received from the greater Milpitas area. This number represents approximately 65 percent of the total 7,394 odor complaints received by the BAAQMD within its nine-county jurisdiction during that same period. Table 1-4 shows complaints were as high as 3,306 in 2015 and dropped as low as 827 in 2019. Similar trends can be seen in the cities of Fremont and San José.

Table 1-4. BAAQMD Received Odor Complaints, South Bay (2015 to 2019)

City	2015	2016	2017	2018	2019
Fremont	546	255	152	83	53
Milpitas	3,306	2,782	1,756	1,707	827
San José	70	43	22	15	9

Based on complaint information provided by BAAQMD, the top complaint areas between 2017 and 2019 in Fremont, Milpitas, and San José are summarized in Table 1-5. These locations account for the majority of the complaints received in the respective year, in comparison to other locations within that city.

Table 1-5. Locations of Highest Number of Complaints (2017 to 2019)

City	2017	2018	2019
Fremont	5500 Simm Ct Fremont Blvd 200 Mayten Way 500 Pistache Terrace 48900 Rusty Leaf Terrace	42400 Osgood Rd 48800 Sauvignon Ct 48900 Air Fern Common	3600 Main Street
Milpitas	1300 Elkwood Dr 1400 Platt Ave 200 Ontario Rd Aspen Ridge Dr 0 Butero Ln 200 Tram Wy 500 maple Ave 0 Berylwood Ln 100 Beaumere Wy	1300 Elkwood Dr 1300 Beaumere Wy 1500 Platt Ave 1900 Baderwood Ln	1300 Elkwood Dr 1500 Hidden creek Ln 1100 California Cir 100 Beaumere Wy 800 N Abbott Ave 100 Sudbury Dr
San José	100 Descanso Dr 4200 Sophia Wy	400 Mill River Ln 400 Camille Cir 4000 Biscotti Pl	4000 Biscotti Pl 300 River Oaks Pkwy

Note: Complaint data is based on block data and no real addresses or names are reflected in the data.

## 2. Field Sampling and Surveying Locations

Three odor sampling events are planned to capture seasonal and/or operational periods. The three events are designed to build upon each other and timed for seasons where odor emissions are potentially the highest (late summer/fall/spring), as follows:

- The first sampling event is a screening sampling activity with the purpose of identifying the primary nuisance odor characters present at each facility and quantifying odor concentrations and intensities. This event is focused on known, identified odor emission sources from each facility based on a review of historical complaint data and observations from site visits conducted at each facility in June 2020. The results of the first sampling event will be used to fine-tune and adjust the specific sampling locations, numbers of samples, and analytical suites that are proposed here for the second sampling event and to provide screening data for Montrose to plan their field monitoring activities. The first odor sampling event was originally planned for late August/early September 2020 but due to wildfires has been delayed to middle of September.
- The second sampling event will be a more comprehensive sampling and analysis event that provides a full suite of sampling methodology and analytical methods. In parallel with Jacobs's second sampling event, Montrose will be conducting mobile, real-time odor sampling and tracing around the three facilities and surrounding neighborhoods under a separate BAAQMD contract. The second odor sampling event is planned for late October 2020 when biosolids cake is typically transferred and weather remains warm with elevated odor emissions. This time frame is ideal for capturing this unique odorous event while expected emissions from all sources are still high.

Results from the first sampling event will inform and potentially modify the second sampling event. Modifications to the second sampling event may include fewer species analysis, possibly more or different sources, and possibly duplicate sampling.

Data collected during the first and second sampling events, along with Montrose results, will be compiled, analyzed and used to identify odor contributions from each of these three facilities. In addition, odor dispersion modeling results will be compared with field olfactometric surveys conducted in the community to ground-truth off-site impacts. Potential data gaps or quality control needs will be identified to design the third sampling event.

- The third sampling event will then focus on collecting data to confirm and strengthen the initial conclusions from the previous sampling events. The third sampling event will also focus on potential off-site odor attribution sources and determine potential community-based, continuous odor monitoring stations and approaches in the South Bay communities. The third sampling event is tentatively planned for March or April 2021.

Off-site field olfactometric sampling will be performed concurrently with the facility sampling events to help validate the major odor sources impacting the neighboring communities.

Proposed sampling locations at the three focus facilities are presented in Table 2-1. The sampling locations for Events 2 and 3 will be adjusted based on the results of the previous sample events.

Table 2-1. Summary of Planned Sampling Events

	Event 1	Event 2	Event 3
Purpose/Rationale	Screening Data Collection	Comprehensive Data Collection	Confirmation Data Collection
Approach	All known locations based on Tour and BAAQMD attributed known major odor sources	Major odor source locations based on Sampling Event 1 including biosolids stockpiling activities	Selected major odor source locations based on Sampling Event 2
Timing	August/September 2020	October 2020	March/April 2021
NIRRP locations	Material Recovery Facility Landfill Working Face Compost Piles Landfill Gas	Material Recovery Facility Landfill Working Face Green Waste Facility Compost Piles Landfill Gas	Material Recovery Facility Landfill Working Face Green Waste Facility Compost Piles Landfill Gas
RWF locations	East Primaries Bioreactors Lagoons Drying Beds	East Primaries Bioreactors Lagoons Drying Beds	East Primaries Bioreactors Lagoons Drying Beds
ZWED locations	Interior Space Biofilter 1	Interior Space Biofilter 1	Interior Space Biofilter 1
Field olfactometric survey	Upwind and downwind all facilities and neighboring communities	Upwind and downwind all facilities and neighboring communities	Upwind and downwind all facilities and neighboring communities

**2.1.1 Sampling Summary Matrixes**

Sampling locations at each of the three facilities were determined based on historical odor measurement, site visit information, and Jacobs and BAAQMD project team member expertise.

A summary of planned sample locations for the three sampling events is summarized in Table 2-2, Table 2-3, and Table 2-4. The tables group the sample locations by facility and identify the various analyses and methodologies that will take place at each location along with the method of collection and equipment used. Locations for the second and third sample events are based on best currently available information and will be revisited following the first and second sample events. The intent of the sample events is to collect data from the most important odor sources from each facility, and as such, this sample plan will be a living document. These tables will be updated prior to the second and third sample events to take into account the results of each successive event, air dispersion modeling results, and findings from the Montrose analyses activities.

It is understood that more samples from the same source would be helpful mainly to identify variation in time and place. These additional samples may be added to later events if the findings from the earlier sampling events so indicate. However, it should be noted that this Sampling Plan is designed to capture worst-case scenarios to inform the evaluation; capture of every condition is beyond the scope of this study. It is further noted that this Odor Attribution Study is not a compliance effort but an odor characterization effort.

Sample locations for each facility are described in further detail in the subsequent sections.



Table 2-2. Sampling Event 1 Summary Matrix

Sampling Set	Source ID	Source	Number of Samples per event	Odor Constituent, Sample Collection, and Sample Analysis Method											
				OPM	Reduced Sulfur	Olfactometry Laboratory (OU/m <sup>3</sup> )	Aldehyde	Amines	VOCs <sup>a</sup>	Carboxylic Acid	Ammonia	Spot H <sub>2</sub> S	H <sub>2</sub> S	Continuous H <sub>2</sub> S	Olfactometer Field (D/T)
				10-L Teflon Bag	1-L Tedlar Bag <sup>d</sup>	10-L Teflon Bag	Sorption Tubes	Sorption Tubes	Sorption Tubes	Sorption Tubes	In-field	In-field	In-field	In-field	In-field
				Modified Standard Method 2170: Flavor Profile Analysis Method (applied to air)	ASTM D5504 Method by Modified GC/SCD with sulfur chemiluminescence	ASTM E679-04 Standard of Practice with a presentation rate of 20 liters per minute (per EN 13725)	TO -11A (EPA 1999)	ALS (sorbent tube) Method 101 (their unique standard method)	TO -17 (EPA 1999)	ALS (sorbent tube) Method 102 (their unique standard method)	Draeger tubes	Jerome Meter	Draeger tubes	OdaLog	Scintroid SM-100
RWF	1	East Primaries	1	X <sup>a</sup>	X	X			X	X		X		X	X
	2	Bioreactors	1	See Note <sup>e</sup>	X	X			X			X			X
	3	Lagoons	1	See Note <sup>e</sup>	X	X	X	X	X	X	X	X			X
	4	Drying Beds	1	See Note <sup>e</sup>	X	X	X	X	X	X	X	X			X
	5	RWF Downwind	multiple												X
	6	RWF Upwind <sup>h</sup>	TBD												
ZWED	7	ZWED Interior Space	1	X <sup>a</sup>	X	X	X	X	X	X	X	X		X	X
	8	Biofilter 1	1	See Note <sup>e</sup>	X	X	X	X	X	X	X	X		X	X
	9	Pressure Relief Valve/Gas Holder Carbon Unit	multiple											X <sup>f</sup>	X <sup>f</sup>
	10	ZWED Downwind	multiple												X
	11	ZWED Upwind <sup>h</sup>	TBD												
NISL	12	Landfill Working Face	1	X <sup>a</sup>	X	X	X	X	X	X	X	X			X
	13	Compost Piles and/or Green Waste Facility and/or Curing Piles <sup>c</sup>	1	X <sup>a</sup>	X	X	X	X	X	X	X	X			X
	14	MRF	1	See Note <sup>e</sup>	X	X	X	X	X	X	X	X			X
	15	Landfill Gas	1	X <sup>a</sup>	X	X	X	X	X <sup>b</sup>	X		X	X		
	16	Leachate Tanks	TBD			X <sup>g</sup>									X
	17	Landfill Downwind	multiple												X
	18	NISL Upwind <sup>h</sup>	TBD												

<sup>a</sup> Duplicate samples to be sent to both University of California at Los Angeles (UCLA) to perform the OPM and generate persistency curves and Montrose to perform an initial scan to identify the wide range of individual compounds and specific markers of these odor sources.

<sup>b</sup> Analyzed also for methane concentrations

<sup>c</sup> Field olfactometer surveys will be used to get a reading of odor intensity and the team will have the flexibility to adjust strategy to include green waste feedstock sampling depending on field conditions as needed

<sup>d</sup> BAAQMD does not allow use of Tedlar bags for TRS analysis. Sulfur poses challenges with regards to sample bag material as it decays in Tedlar bags and diffuses in Teflon bags. If samples will be analyzed within appropriate holding time (24 hours in this case), these materials may be acceptable for the first sampling event, which is designed to be a screening event.

<sup>e</sup> A single 10-liter bag or four 1-liter samples delivered to UCLA for OPM only (no persistency curves)

<sup>f</sup> Field observance will dictate if the PRV or gas holder carbon unit is sampled

<sup>g</sup> Leachate tanks will be observed on the day of sampling and if odorous limited samples will be collected

<sup>h</sup> Collect two 1 liter Tedlar bags for Montrose as "control" bags if wildfire smoke conditions exist with an air quality index value of > 50 (moderate).

Notes:

d/t = dilutions to threshold

EN = European norm

L = liter

OPM = Odor Profile Method

OU/m<sup>3</sup> = odor units per cubic meter

TBD = to be determined

Table 2-3. Sampling Event 2 Summary Matrix

Sampling Set	Source ID	Source	Number of Samples per event	Odor Constituent, Sample Collection and Sample Analysis Method											
				OPM	Reduced Sulfur	Olfactometry Laboratory (OU/m <sup>3</sup> )	Aldehyde	Amines	VOCs	Carboxylic Acid	Ammonia	Spot H <sub>2</sub> S	H <sub>2</sub> S	Continuous H <sub>2</sub> S	Olfactometer Field (D/T)
				Teflon Bag	Tedlar Bag <sup>d</sup>	Teflon Bag	Sorption Tubes	Sorption Tubes	Sorption Tubes	Sorption Tubes	In-field	In-field	In-field	In-field	In-field
				Modified Standard Method 2170: Flavor Profile Analysis Method (applied to air)	ASTM D5504 Method by Modified GC/SCD with sulfur chemiluminescence	ASTM E679-04 Standard of Practice with a presentation rate of 20 liters per minute (per EN 13725)	TO -11A (EPA 1999)	ALS (sorbent tube) Method 101 (their unique standard method)	TO -17 (EPA 1999)	ALS (sorbent tube) Method 102 (their unique standard method)	Draeger tubes	Jerome Meter	Draeger tubes	OdaLog	Scentroid SM-100
RWF	1	East Primaries	1	X <sup>a</sup>	X	X				X	X		X		X
	2	Bioreactors	1		X	X				X			X		X
	3	Lagoons	1	X <sup>a</sup>	X	X	X	X	X	X	X	X	X		X
	4	Drying Beds	1		X	X	X	X	X	X	X	X	X		X
	5	RWF Downwind	multiple	X <sup>a</sup>											X
ZWED	6	ZWED Interior Space	1	X <sup>a</sup>	X	X	X	X	X	X	X		X	X	X
	7	Biofilter 1 <sup>b</sup>	1		X	X	X	X	X	X	X	X	X	X	X
	8	Pressure Relief Valve/Gas Holder Carbon Unit	multiple		X <sup>e</sup>	X <sup>e</sup>	X <sup>e</sup>	X <sup>e</sup>	X <sup>e</sup>	X <sup>e</sup>	X <sup>e</sup>	X <sup>e</sup>	X <sup>e</sup>	X <sup>e</sup>	X <sup>e</sup>
	9	ZWED Downwind	multiple												X
NISL	10	Landfill Working Face <sup>c</sup>	1	X <sup>a</sup>	X	X	X	X	X	X	X		X		X
	11	Compost Piles and/or Green Waste Facility and/or Curing Piles	2	X <sup>a</sup>	X	X	X	X	X	X	X		X		X
	12	MRF	1	X <sup>a</sup>		X									X
	13	Biosolids Stockpiling	1	X <sup>a</sup>	X	X	X	X	X	X	X	x	x	X	X
	14	Leachate Tanks	TBD												
	15	Landfill Downwind	multiple												X

<sup>a</sup> Duplicate samples to be sent to both UCLA (to perform the OPM and generate persistency curves) and Montrose (to perform an initial scan to identify the wide range of individual compounds and specific markers of these odor sources)

<sup>b</sup> The biofilter will be sampled when opening the dry digestion cell.

<sup>c</sup> The working face will be sampled during dumping of ZWED overs. This will require careful coordination to ensure this elevated emissions source is properly captured.

<sup>d</sup> It is noted that BAAQMD does not allow the use of Tedlar bags for TRS analysis. Jacobs will research other options (including Teflon, aluminized mylar bags, coated cannisters; and bag conditioning or passivating) for this sampling event

<sup>e</sup> Field observance will dictate if the PRV or gas holder carbon unit is sampled

<sup>f</sup> Leachate tanks will be sampled if the results of Sample Event No. 1 indicate this to be a key source

Note: This sampling matrix will be updated based on the results of Sampling Event 1.

TBD = to be decided based on findings from Sampling Events 1

Table 2-4. Sampling Event 3 Summary Matrix

Sampling Set	Source ID	Source	Number of Samples per event	Odor Constituent, Sample Collection and Sample Analysis Method											
				Odor Profile Method (OPM)	Reduced Sulfur	Olfactometry Laboratory (OU/m <sup>3</sup> )	Aldehyde	Amines	VOCs <sup>1</sup>	Carboxylic Acid	Ammonia	Spot H <sub>2</sub> S	H <sub>2</sub> S	Continuous H <sub>2</sub> S	Olfactometer Field (D/T)
				Teflon Bag	Tedlar Bag <sup>c</sup>	Teflon Bag	Sorption Tubes	Sorption Tubes	Sorption Tubes	Sorption Tubes	In-field	In-field	In-field	In-field	In-field
				Modified Standard Method 2170: Flavor Profile Analysis Method (applied to air)	ASTM D5504 Method by Modified GC/SCD with sulfur chemiluminescence	ASTM E679-04 Standard of Practice with a presentation rate of 20 liters per minute (per EN 13725)	TO - 11A (EPA 1999)	ALS (sorbent tube) Method 101 (their unique standard method)	TO - 17 (EPA 1999)	ALS (sorbent tube) Method 102 (their unique standard method)	Draeger tubes	Jerome Meter	Draeger tubes	OdaLog	Scentroid SM-100
RWF	1	East Primaries	1	X <sup>a</sup>	TBD	X			TBD	TBD		TBD			
	2	Bioreactors	1		TBD	X			TBD			TBD			
	3	Lagoons	1	X <sup>a</sup>	TBD	X	TBD	TBD	TBD	TBD	TBD	TBD	TBD		
	4	Drying Beds	1		TBD	X	TBD	TBD	TBD	TBD	TBD	TBD			
	5	RWF Downwind	multiple												X
ZWED	6	ZWED Interior Space	1	X <sup>a</sup>	TBD	X	TBD	TBD	TBD	TBD		TBD			
	7	Biofilter 1	1		TBD	X	TBD	TBD	TBD	TBD	TBD	TBD			
	8	Pressure Relief Valve/Gas Holder Carbon Unit <sup>b</sup>	multiple		TBD				TBD	TBD		TBD			X
	9	ZWED Downwind	multiple												X
NISL	10	Landfill Working Face	1	X <sup>a</sup>	TBD	X	TBD	TBD	TBD	TBD	TBD	TBD			
	11	Compost Piles and/or Green Waste Facility and/or Curing Piles	1		TBD	X	TBD	TBD	TBD	TBD	TBD	TBD			
	12	MRF	1		TBD	X	TBD	TBD	TBD	TBD		TBD			
	13	Landfill Gas	1		TBD	X	TBD		TBD	TBD		TBD	TBD		
	14	Leachate Tanks	TBD		TBD	TBD	TBD	TBD	TBD	TBD	TBD	TBD	TBD		TBD
	15	Landfill Downwind	multiple												X

<sup>a</sup> Duplicate samples to be sent to both UCLA (to perform the OPM and generate persistency curves) and Montrose (to perform an initial scan to identify the wide range of individual compounds and specific markers of these odor sources)

<sup>b</sup> To be sampled if Montrose finds an associated fingerprint compound offsite.

<sup>c</sup> It is noted that BAAQMD does not allow the use of Tedlar bags for TRS analysis. Jacobs will research other options (including Teflon, aluminized mylar bags, coated cannisters; and bag conditioning or passivating) for this sampling event

Notes: This sampling matrix will be updated based on the results of Sampling Events 1 and 2.

TBD = To be decided based on findings from Sampling Events 1 and 2.

### 2.1.2 Newby Island Resource Recovery Park Sampling Locations

Odor emissions from the facility are dynamic in nature and therefore, the analysis of these processes must take into account varying odor emission characteristics. For example, the working face of the landfill does not operate during nighttime and is covered to prevent odor emissions. However, some of the processes (like the composting windrows) will still be emitting odors. Further, each process area includes certain operations that have continuous emissions and other operations that have only intermittent emissions. For example, the compost facility has odor emissions once compost is transported from the aerated-static pile to the curing pile, albeit short-term (intermittent). The grinding of green waste represents short-term (intermittent) emissions from this process, while the green waste stockpiles represent continuous emissions. In addition to time-varying emissions, some processes may have different odor emissions, depending on the feedstock and the activity at the process area. For example, the dumping of commercial waste at the working face emits generally lower odors than when ZWED waste was being dumped.

Each of the various processes has unique odor compounds associated with it, including alkyl benzenes, hydrocarbons, esters and methyl mercaptan among many others. To characterize the various odors, each of the major processes will be sampled to determine their unique odor “fingerprint”. The processes include the working landfill face, composting piles, green waste, and landfill gas, as well as the MRF. The biosolids cake stockpiling area odor emissions will be assessed based on the agitated cake sampled from the cake drying beds.

**Landfill Face:** Both commercial waste dumping conditions and higher odor ZWED “overs” dumping conditions will be characterized by sampling each condition separately.

**MRF:** To understand how conditions vary throughout the day, samples will be collected in the morning during one sampling event and in the afternoon during a second sampling event. Ambient air samples will be collected inside the building using Teflon tubing and a vacuum chamber.

**Composting Piles:** It is understood that odor concentration in the piles varies over time. Therefore, two samples may be taken over two sampling events. The first sample will be collected from a pile that has been in operation for less than a week, and a second sample may be taken from a pile that has been in operation for more than two weeks.

**Green Waste:** Although there is potential for both the stockpile area and the fresh ground waste to emit odors, it is likely that the freshly ground waste comingled with food waste will exhibit more odors.

**Landfill Gas:** To assess odor potential from gas leaks at gas collection wells, a sample will be collected at the inlet of the gas collection system. The sample will measure methane and odor concentration of the undiluted sample, which will provide an understanding of emissions from the wells before it is diluted by fresh, ambient, air. Samples will be collected by connecting Teflon tubing to a sample port on the inlet side of gas collection system and using a vacuum chamber to pull the sample into the appropriate sample bags.

### 2.1.3 RWF Sampling Locations

Jacobs (as CH2M Hill) completed the 2014 odor control study at the RWF. To supplement the data from that previous work, this Study will focus on sampling at a few key sources: east primary clarifiers, BNR facility, lagoons, and sludge-drying beds. As part of the odor studies conducted in 2011, 2012, and 2014 at the RWF, sampling data were collected from the various unit processes and used to predict the off-site odor impacts resulting from the existing treatment processes and to quantify and characterize RWF odor sources. Odor emission rates were calculated for each source and ranked in terms of magnitude. The open-air lagoons, east primary clarifiers, drying beds, aeration basins (BNRs), and primary effluent pump station equalization basins were found to be major sources in terms of odor emission rates.

The baseline odor emission rate from each source was used as input into an EPA-approved atmospheric odor dispersion model to understand the RWF's off-site odor impacts under baseline conditions. In addition to considering the existing odor sources, the studies also considered the future scenario in which odor control discharge stacks and sources from new treatment processes, such as the new headworks, temperature-phased anaerobic digestion, DAFT facilities, and new digested sludge dewatering facility would come online. Odor emission rates for each future source were developed for input into the baseline dispersion model to assess off-site impacts, and to establish loading rates for the purpose of recommending odor control technologies and equipment sizing.

The five top odor contributing units based on odor emission rates were found to be:

- East primary clarifiers (existing, modified)
- Digested sludge dewatering facility, including truck load-out (new)
- Headworks 2 (existing, modified)
- Headworks 3 (new)
- DAFT facility (existing, modified)

**East Primary Clarifiers:** The effluent launders are typically more odorous than the other portions of the clarifiers due to the turbulent flow of the liquid stripping the sulfur odorous compounds out and turning them into vapor. This source will be sampled by floating a flux chamber on top of the liquid, then using a vacuum chamber to pull the sample into sample bags.

**BNR:** To understand the odor potential for both the anoxic and aerobic zones, the initial sampling event in August will sample from the anoxic without aeration occurring and the second sampling event in October will sample from the aerobic zone with aeration occurring. Both samples will be collected by floating a flux chamber on top of the liquid, while a vacuum chamber draws the sample into the appropriate sample bag.

**Lagoons:** Each of the lagoons is filled with sludge of varying age, so at any given time, one lagoon may have a solid surface, whereas the adjacent lagoon may be mainly liquid. The varying age and liquid/solid state will also create varying odor conditions with the solid surface believed to be more odorous. Additionally, during a site visit conducted by Jacobs staff on June 24, 2020, odors were observed when the wind picked up and created choppy conditions in the lagoon. Given the various odor scenarios, three odor samples will be taken, one during each odor sampling event. Samples will be taken during the following conditions:

- Digested sludge is currently, or was recently, discharged;
- Aged sludge that has a water cap;
- Choppy conditions generated by strong winds.

Samples will be collected by floating a flux chamber on top of the liquid, ensuring that the flux chamber is stabilized so as to limit movement and minimize fresh air entering the chamber. Either a flotation device or a suspension system will be utilized for placement of the flux chamber on the liquid surface. A vacuum chamber will be used to draw the sample into the appropriate sample bag. Wind conditions (speed and direction) will be recorded at the time of sample collection.

**Sludge-Drying Beds:** To understand typical and atypical conditions, non-agitated sludge will be sampled during the first event in September, and agitated sludge cake will be sampled during the October sampling event when sludge is being disturbed and hauled offsite. Figure 2-1 shows the sludge beds in an undisturbed condition.



Figure 2-1. RWF Sludge Drying Beds

#### 2.1.4 ZWED Sampling Locations

To characterize odors generated from this facility, the following locations will be sampled:

**ZWED Interior Space:** To understand how conditions vary throughout the day samples will be collected in the morning during one sampling event and in the afternoon during a second sampling event. Ambient air samples will be collected inside the building using Teflon tubing and a vacuum chamber.

**Biofilter Exhaust:** Two samples will be taken from the biofilter: one collected during normal operation when only foul air from the building interior and composting vessels is sent to the units, and a second when a digester is being degassed and adding additional odor to the foul air stream. Samples will be collected by placing a flux chamber on top of the biofilters, making sure to imbed the flux chamber in the media so that fresh air contamination is limited. A vacuum chamber will then draw the sample into the appropriate sample bags.

#### 2.1.5 Field Olfactometric Survey Locations

Several survey locations were selected in Fremont, Milpitas, and San José to quantify odors downwind and upwind from each facility as well as in the community (Figure 2-2). Downwind and upwind locations were identified for each of the facilities and were selected based on prevailing wind direction (northwest to southwest). These locations are suggested starting points but are subject to change depending on the wind direction the day of the survey. Community locations were identified based on historical odor complaint data. Areas of potential high concentrations were identified, and survey locations were spread out among each of the areas to try and capture odors present.

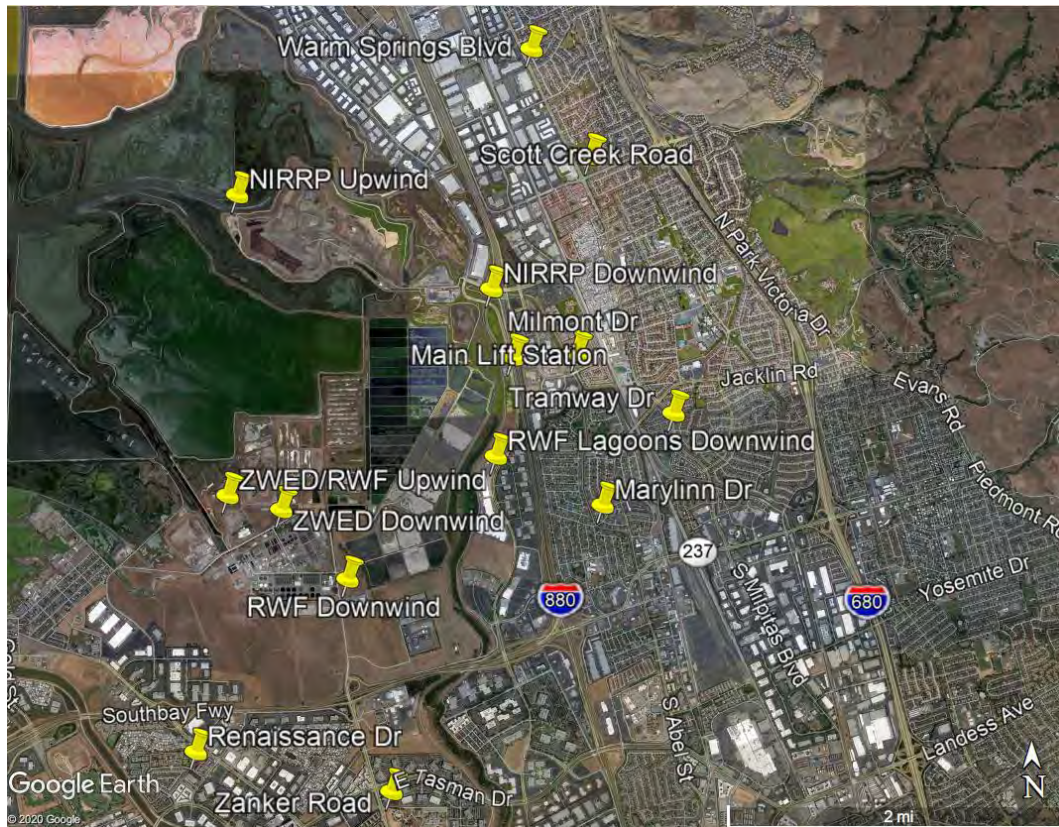

Figure 2-2. Field Olfactometric Survey Locations (source: Google Earth)

In addition to historical complaint data, odor survey data collected by the City of Milpitas from October 2019 through March 2020, and July 2020, was considered. The City collected data from 11 locations, including downwind from each facility and seven locations in the community, which were identified based on 2015 complaint data. The City noted when odor was present and quantified odor intensity using a Scentroid SM100. Locations that were continuously identified as having odors were included while locations that were included in the survey for this study and locations that were identified on the historical complaint data but found to have no odors throughout Milpitas's survey effort were removed.

Four locations downwind of each facility were selected:

- North McCarthy Road and Coyote Creek Trail (Newby Island)
- North McCarthy Road at north entrance to commercial complex parking lot (RWF Lagoons)
- Los Esteros Road in RWF administration building parking lot (ZWED)
- Zanker Road at entrance to Advanced Water Treatment facility (RWF)

Two locations upwind of each facility were selected:

- NIRR perimeter access road in the northwest corner of the facility (Newby Island)
- Grand Blvd across from the north east corner of the Zanker Materials Recovery and Landfill (RWF Lagoons)

Eight community locations were selected:

- Scott Creek Road and Warm Springs Boulevard (Fremont)
- Warm Springs Boulevard and Starlite Way (Fremont)
- Main Lift Station (Milpitas)
- Milmont Drive and Fairview Way (Milpitas)



- Tramway Drive and N Milpitas Boulevard (Milpitas)
- Marylinn Drive and Penitencia Street (Milpitas)
- Renaissance Drive and Vista Montana (San José)
- Zanker Road and Estanica Drive (San José)

### 3. Sampling Approach and Methodology

Jacobs will deploy a two-person team for field sampling at all facilities. It is expected that each sample event will take place over the course of a week. All samples must be shipped off by Thursday to avoid laboratory analyses conducted over the weekend.

Proposed sampling and analysis approaches and methods are focused on being viable for all three sampling events and to conform to industry best practices and approved BAAQMD and EPA methods and protocols. Sampling methodology and analysis methods and approaches are described in general.

California wildfire impacts must be considered in the planning and execution of the late summer and fall sampling events. Field and ambient measurements may potentially be impacted by smoke, but not necessarily source sampling (flux chambers/hoods) in which area or point sources are measured. If wildfires occur and resulting smoke poses an unfavorable risk to odor measurement results, sample events may need to be postponed. Jacobs and Montrose will do everything in their power to maintain overall project schedule by possibly conducting sample events “back-to-back” as necessary. The main limitation is time required to synthesize sample results from the previous sample event to best inform the forthcoming event coupled with required timing for logistics. In addition, Montrose will require time to procure calibration gases for their analytical equipment.

#### 3.1 Sample Collection Methodology

There are two primary modes of sampling, “grab” sampling and “time-integrated” sampling. For the purposes of meeting the goals of this sampling effort, only grab sampling will be conducted. Time-integrated sampling is more useful where a time-based average is sought.

The following sample collection methodologies will be utilized to accommodate the range of odorous emission sources present at the focus facilities:

- **Area Sources:** There are two commonly used methods for collecting air samples from area sources. These include the flux chamber technique and the wind tunnel technique. Due to difficulties in setting up the wind tunnel technique method, and the fact that the flux chamber method is considered industry standard, the flux chamber technique will be implemented herein. See Subsection 3.1.1 for details pertaining to both liquid and solid surfaces.
- **Fugitive Interior Space Sources:** Sampling from sources such as interior spaces with open doors or windows can be challenging. The proposed method herein will use a lung (vacuum chamber) technique placed in a location within the space to 1) limit dilution effects from open doors and windows, 2) ensure odor is well mixed, and 3) limit dilution from makeup air systems.
- **Point Sources:** Point sources including ducts and stacks will be sampled using a lung (vacuum chamber) connected to the source via an air-tight connection and inert (such as Teflon) tubing. Multi-point sampling is not believed to be necessary since uniformity and homogeneous mixing within the duct is assumed (EPA 2012).
- **Atypical Sources:** Atypical sources will be sampled as follows:
  - **PRVs:** For this type of source the technique described herein for point sources will be employed with the extraction tube inserted into the PRV hood assembly to limit environmental impacts due to wind.
  - **Aerated Surface Area Sources:** Same as area sources described above except that process air flux rate will be incorporated into calculating any surface emission factors.

- Undulating Surface Area Sources: Sources including RWF Primary Clarifier Effluent Launderers consist of features that prevent sealing of flux chamber bottom to source surface. For these types of sources, the flux chamber will be placed as close to the turbulent feature as practical while meeting the requirements set forth in Subsection 3.1.1.

Air/odor samples on any area emissions sources (such as lagoons, compost piles, aerated liquid/solid processes, and similar) will be collected using the Flux Chamber Methodology. This approach is accepted by EPA and BAAQMD for air quality emissions sampling and will be applied to address target odorants in the same fashion. Point or stack odor emissions sources will be sampled using several methodologies including bag sampling, ambient measurements, and analytical instruments. These various methodologies are summarized and include referenced BAAQMD, EPA, and industry best practices references.

The sources where bag samples will be taken will also be sampled with the field olfactometer at the same time. The measurement with the field olfactometer will be used as quality control.

Sources might be sampled with the field olfactometer at a different time during the sampling day or at a different day to improve the accuracy of the odor concentration measurement depending on the results and the contribution of the source to the total odor emission at the plant.

### 3.1.1 Flux Chamber Sampling (for area sources – liquid and solid surfaces)

The surface emission isolation flux chamber can be used on any liquid surface and on solid surfaces; an EPA flux chamber is shown on Figure 3-1. The only requirement regarding application is that there must be access to the surface for testing. If the surface cannot support the chamber, the chamber must be suspended or equipped with a flotation device or suspended from overhead. Flux chamber methodology will comply with EPA Environmental Restoration Division Standard Operating Procedure 1.11, Soil Surface Flux Monitoring of Gaseous Emission (1999).

Two different EPA chambers exist. One is modified for high flow rates (e.g., biofilters and composting including stockpiles where flows exceed 70 liters per minute for conventional 16-inch diameter flux hood). This unit follows the SCAQMD Rule 1133 Specification and uses a helium tracer to quantify flux chamber flow. The high rate flux chambers are less readily available. However, it is understood that BAAQMD has at least one. It is recommended that BAAQMD's flux rate expert participate in the sampling effort and consider using this equipment where considered technically beneficial.



Figure 3-1. EPA Flux Chamber with Sampling Equipment

There are two types of flux-chamber methods: the Static (Closed) Chamber Method and the Dynamic Chamber Method. The static chamber method does not include introduction of a sweep gas. Advantages include simpler setup and operation. The main disadvantage is the possibility of impeding flux due to buildup of high concentrations. The dynamic chamber method includes introduction of sweep gas during a pre-set incubation period to ensure steady-state conditions are met. The dynamic-chamber method is considered industry standard and is proposed here.

For sampling natural or uncontrolled systems, the most critical issue regarding application is that the location and number of locations for testing be sufficient so that these data can be used to calculate the total emissions from the emitting surface area. The User's Guide (EPA 1986) provides guidance that relies on the area involved and the homogeneity of the source or the coefficient of variation of these emission data for determining representative testing.

For sampling engineered systems (process tankage), the representative surface areas are selected. Given that the solid/liquid surface tested is relatively uniform, it is anticipated that the measurements will be representative of the air emissions from the process.

Samples will be collected by placing a flux chamber on top of the various media (such as liquid surface, piles, biofilters, or sludge), making sure to imbed the flux chamber in the media so that fresh air contamination is limited. Sweep gas will be introduced. A vacuum chamber will then draw the sample into the appropriate sample bags.

Using a flux chamber on a solid or compost surface requires the chamber to be partially buried to match the surface pressure to be accurate. This depth should be 2 to 3 centimeters (cm) (approximately 1-inch) (EPA 1986).

The operation of the EPA low-flow flux chamber is as follows:

- Identifying the test area
- Initiating sweep gas flow rate to the flux chamber
- Operating the chamber for at least four residence times
- Collecting exhaust gas for analysis and/or recording instrument response
- Decontaminating the chamber
- Relocating the measurement equipment to the next test area

The specific operating protocol for the EPA approved low-flow flux chamber sampling is as follows:

- Locate the flux chamber, sweep gas (if applicable), sample collection equipment, and field documents at the test location.
- Document site information, location information, equipment information, name of sampler, date, and time on the Field Data Sheet.
- Select the exact test location and place the chamber approximately ¼ inch into test surface or sealed on an adaptor box apparatus. The chamber should be sealed, when possible, along the base to prevent air infiltration.
- Initiate the sweep gas flow rate (where sweep gas is utilized) and set the rotameter at 5.0 liters per minute (L/min) (flux chamber area of 0.13 square meters). Where sweep gas is utilized, constant sweep gas flow rate is critical. Record the time.
- Connect the vacuum pump. A total of 5.0 L/min is added to the chamber as sweep gas (where utilized) and the gas not sampled is exhausted out the pressure equalization port in the top of the chamber. The chamber is operated at near atmospheric pressure. Typical sampling rate from the flux hood is 1.0 to 2.0 L/min. This excess sweep air will prevent entraining of ambient air into the chamber and maintain an exhaust rate of at least 3.0 L/min out of the pressure equalization port.
- Operate the chamber sweep air flow rate (where utilized) at 5.0 L/min and record data every residence time (8 minutes) for four residence times or 30 minutes to allow chamber to come to equilibrium with emissions diffusing from the surface. Record the data. The chamber is at steady state.
- Label sample bag before placing in vacuum chamber.

- Interface the bag sampler/sample bag or solid sorbent media to the purged sample line and collect the gas sample. Do not exceed a collection rate of 2.0 L/min at any time. This will prevent unwanted dilution of chamber exhaust gas by ambient air.
- Record sample collection or real-time monitoring data on the data sheet.
- Store the sample(s) in the appropriate storage or shipping container.
- Document sample collection in-field master logbook.
- Discontinue the flux measurement, shut off the sweep air (where utilized), remove chamber, and secure equipment.

The operation of the SCAQMD Rule 1133 high air flow flux chamber will include helium tracer gas. Specific operating protocol will be finalized with BAAQMD prior to sampling.

Jacobs will coordinate with the BAAQMD testing group for utilization of the high air flow rate flux chamber during all sampling events. However, if the BAAQMD testing group cannot provide assistance for Sample Event No. 1 due to scheduling or workload issues, the standard EPA approved low-flow flux chamber is proposed to be utilized for the ZWED biofilter and the NISL compost pile. This is believed to be appropriate since Sample Event No. 1 is a screening event more focused on identifying fingerprint odorants. For the second and third sampling events, the high airflow rate flux chamber will be utilized since those events are considered more comprehensive events for determining emission rates.

### **3.1.2 Bag Sampling (for flux chamber emissions and point sources)**

Samples using Tedlar and Teflon bags will be collected directly from the vacuum chamber connected to the exhaust line of the flux chamber (area source) at steady-state conditions or connected to the stack or duct sources (point sources) as described. Bags will then be sent to the defined laboratory for speciation by gas chromatography, odor analysis, OPM, or musty and fecal analysis. Sampling rate will be maintained at less than 2.0 L/min from the vacuum chamber. Sample bags will be filled by connecting the sampler to duct ports, access hatches, or the sampling port on the flux chamber using the ¼-inch Swage-lock fittings, drawing a vacuum on the vacuum chamber, and filling the bag collecting a 1- to- 10-liter sample. Sample bags will be preconditioned by partially filling, then expelling, the bag contents with the sample prior to taking the final sample.

Bags will be Tedlar material for all analysis types except for bags sent to UCLA for OPM analysis. Due to the “sticky” nature of fecal odorants, samples sent to UCLA will be in Teflon bags (Suffet 2016).

BAAQMD does not allow use of Tedlar bags for TRS analysis. Sulfur poses challenges with regards to sample bag material as it decays in Tedlar bags and diffuses in Teflon bags. If samples are analyzed within appropriate holding time (24 hours in this case), these materials are considered acceptable for the first sampling event, which is designed to be a screening event. Jacobs will research other options (including Teflon, aluminized mylar bags, coated cannisters; and bag conditioning or passivating) for forthcoming sampling events.

### 3.1.3 Sorbent Media Sampling

Sorbent media samples will be collected using variable flow sampling pump connected directly to the source (point source) using silicon tubing/Teflon tubing or to the exhaust line of the flux chamber (area source). Sampling rate will be maintained at the recommended rate determined by the laboratory conducting the analysis. The sampling pump will be calibrated before use and operated for the recommended sampling time to pull the required volume through the media in each tube. This time will vary depending on the type of sorbent media but can be of long duration (up to and exceeding an hour each). The sampling pump will be post-calibrated after use and the average of the pre- and post-calibration will be used to calculate the average flow rate of the sample collection for the timed interval. Figure 3-2 shows a typical setup for sampling off a stack using multiple sampling pumps and sorbent tubes.



Figure 3-2. Sorbent Tubes and Sampling Pumps

### 3.1.4 Summa Canister Sampling (TO-15 if implemented)

A “whole air” sample is collected when the air is drawn into some sort of vessel (such as a Tedlar bag, glass bulb, stainless steel “bomb”, or a canister). The most two common methods for collecting a whole air sample are stainless steel Summa canisters and Tedlar bags. The Summa canister comes pre-charged under vacuum. Collection of the air sample requires simply to open the canister valve after having connected the canister to the source odor. This sampling method may be utilized for either area or point sources.

### 3.1.5 Methane Measurements

For Newby Island, landfill biogas and biogas header systems can result in fugitive odors depending on header performance and biogas well locations. It is proposed that concentrated biogas be sampled as indicated herein for the purpose of odor characterization as well as correlating methane concentration to D/T. This correlation can be utilized with ambient facility-wide methane survey data completed by Newby Island semi-annually to map predicted fugitive odors resulting from biogas emissions.

### 3.1.6 High Temperature Source Sampling

Some sources such as the biogas cogeneration engine exhaust stack source may exhibit high temperatures, resulting in a bag sample that will exhibit significant condensation which can impact odor characterization. Therefore, for those bag samples the following approach will be implemented:

- Using hand-held temperature sensor, measure sample gas temperature and record.
- Calculating moisture content of sample gas assuming 100 percent relative humidity. Based on the moisture content calculated, determine the required dilution ratio of dry inert nitrogen gas required to ensure sample gas in bag does not drop below wet bulb temperature (such as preventing condensation in transit). Note: Calculating this volume of dry inert gas is preferred prior to sampling to save time in the field.
- Using a high purity nitrogen tank and rotameter and tubing assembly, precharge the Tedlar or Teflon bag with a preset volume of inert nitrogen gas.
- Using flux hood or vacuum chamber complete with rotameter, fill bag with a preset volume of sample gas.

### 3.1.7 Explosive Source Sampling

Some sources, such as the landfill biogas source, may exhibit high concentrations of methane exceeding the lower explosive limit, resulting in a bag sample that is considered explosive and cannot be shipped to the laboratory using conventional methods. Therefore, for those bag samples, the following approach will be implemented:

- Using a hand-held methane sensor, measure sample gas methane concentration and record.
- Using a high-purity nitrogen tank, rotameter, and tubing assembly, precharge the Tedlar or Teflon bag with a preset volume of inert nitrogen gas (approximately 60 percent full). Note that preliminary calculations estimate that a minimum dilution ratio of 100:1 will be required for landfill biogas.
- Typical landfill biogas can exhibit odor concentrations in the range of 2,000,000 and 3,000,000 D/T. Therefore, diluting 100X will reduce expected sample concentration to 20,000 to 30,000, which falls below the maximum detectable St. Croix laboratory limit.
- Using a flux hood and/or vacuum chamber complete with rotameter, fill bag with a preset volume of sample gas (1/100 x volume of precharge volume).
- Using hand-held methane sensor, measure methane concentration from bag and record.

### 3.2 Laboratory Analytical Methods

Table 3-1 summarizes the targeted sampled odorant and the conforming BAAQMD approved analysis and protocols used during the three sampling events.

Table 3-1. Summary of Targeted Sampled Odorant and Protocols

Odorant	BAAQMD Analytical Method	EPA Analytical Method	Industry Accepted Analytical Method	UCLA Analytical Method	Odor Laboratory Analytical Method
Reduced Sulfur Compounds	ST-11 (BAAQMD 1982) ST-08 (BAAQMD 1982)	TO-14 (EPA 1999) EPA Method 16M	ASTM D5504 Method by Modified GC/SCD with sulfur chemiluminescence detection.	N/A	N/A
General Odor	ST-12 (BAAQMD 1982)	N/A	ASTM E679-04 Standard of Practice with a presentation rate of 20 L/min (per EN 13725)	N/A	ASTM E679-04 Standard of Practice with a presentation rate of 20 L/min (per EN 13725)
OPM	N/A	N/A	N/A	Modified Standard Method 2170: Flavor Profile Method	Limited Intensity/ Dilution Curves
Methyl Isoborneol (MIB) Isopropyl Methyl Pyrazine (IPMP) Skatole Indole	N/A	N/A	N/A	Gas Chromatography/Mass Spectrometry	N/A

Odorant	BAAQMD Analytical Method	EPA Analytical Method	Industry Accepted Analytical Method	UCLA Analytical Method	Odor Laboratory Analytical Method
Aldehydes	N/A	TO-05 (EPA 1999) TO-11A (EPA 1999)	TO -11A (EPA 1999)	N/A	N/A
Amines	ST-22 (BAAQMD 1982)	EPA CTM-027 (EPA 1997)	ALS (sorbent tube) Method 101 (their unique standard method) South Coast AQMD Method 207.1 (SCAQMD 2006) (amines as well as ammonia) Atmospheric Analysis and Consulting, Inc.; impinger gets to lower MRL	N/A	N/A
Ammonia	South Coast AQMD Method 207.1 (SCAQMD 2006)	N/A	OSHA ID-188 method Draeger tubes South Coast AQMD Method 207.1 (SCAQMD 2006) (amines as well as ammonia)	N/A	N/A
H2S	ST-21 (BAAQMD 1982)	EPA Method 16M	Jerome (< 50 ppmV) Draeger tubes (> 50 ppmV) OdaLog/Acrulog (> 0.1 ppmV) ASTM D5504 Method by Modified GC/SCD with sulfur chemiluminescence detection (5 ppb MRL).	N/A	N/A
VOCa	TO-15 (EPA 1999)	TO-17 (EPA 1999) TO-15 (EPA 1999)	TO -17 (EPA 1999) TO -15 (EPA 1999)	N/A	N/A
Carboxylic Acid	N/A	N/A	ALS (sorbent tube) Method 102 (their unique standard method)	N/A	N/A

<sup>a</sup> EPA Method TO-15 uses Summa canister and generally has larger list of compounds. EPA Method TO-17 uses pump with sorbent tube and can characterize a broader range of target odorants, including semi-volatile (water soluble) compounds. TO-17 preferred over TO-15.

Notes:

CTM = Conditional Test Method

HPLC = High Performance Liquid Chromatography

MRL = Method Reporting Limit

ppmV = parts per million by volume

TO = Toxic Organics

ST = Source Test



All foul air samples are to be analyzed analytically by ALS Environmental Laboratories (Simi Valley, California); odor threshold by St. Croix Sensory (Stillwater, Minnesota); and by the OPM and GC/MS in parallel with GC-Sniff testing by UCLA (California).

Table 3-2 summarizes the analytical methods. Note that in some cases, specific odorants are listed that fall under a broader category. For example, specific reduced sulfur compounds fall under the broader category of Total Reduced Sulfur Compounds.

Table 3-2. Analytical Methods Test Plan

Odorant	Low Odor Threshold (ppbV) <sup>a</sup>	Sampling Technique	Analytical Technique	Method Reporting Limit (ppbV)
Methyl Mercaptan	0.077	Grab sample into 1-L Tedlar or other <sup>b</sup> bag	ASTM D5504 Method by Modified GC/SCD with sulfur chemiluminescence detection.	5.0
Dimethyl Disulfide	0.22			2.5
Dimethyl Sulfide	3.0			5.0
H <sub>2</sub> S	0.51			5.0
Ammonia	1,300	Sorbent tube or Draeger tube	OSHA ID-188 method	600
Amines	Varies 0.032	Sorbent tube	ALS Method 101	Varies 0.8
VOCs and similar	Varies	Sorbent tube	TO-17	Varies
OPM	N/A	Grab sample into 10-L Teflon bag	SM 2170 applied to air samples	N/A
Methyl Isoborneol (MIB)	0.02	2-Grab sample into 10-L Teflon bag within 6 hours	GC/MS	0.04
Isopropyl Methyl Pyrazine (IPMP)	0.004			0.1
Skatole	0.018			0.15
Indole	0.5			0.25
General Odor (dilutions-to-threshold)	N/A	Grab sample into 10-L Tedlar bag	Odor panel per ASTM E679-04 Standard of Practice with a presentation rate of 20 liters per minute (per EN 13725)	N/A

<sup>a</sup> OTVs as determined during Phase I of OCSD Odor Control Masterplan project and recognized published papers

<sup>b</sup> It is noted that BAAQMD does not allow the use of Tedlar bags for TRS analysis. Jacobs will research other options (including Teflon, aluminized mylar bags, coated canisters; and bag conditioning or passivating).

Note:

ppbV = part per billion by volume

The following subsections further describe the sampling and analysis methods to be conducted.

### 3.2.1 Odor Profile Method

OPM has been used since the 1980s to characterize odor sources and to identify effective analytical methods in order to understand what causes the odor problems in drinking water. OPM uses odorant standards of odors typically present in a wastewater treatment process to train panelists before using real life odor samples. The

odors assessed are rated by their particular odor strength using a seven-point odor intensity scale. The use of the Weber-Fechner Law translates the intensities detected by the panelists into odorant concentration. The usefulness of the OPM lies in the fact that the human nose is, for the most important odorants, many degrees more sensitive than the standard analytical methodologies. The proof of this is that even though a chemical sample result may show non-detects for all compounds, the D/T of that same sample comes back with considerable odor dilution to threshold results. The Weber-Fechner curves were then used to determine each "most detectable" odorant's nuisance concentration equivalent to an odor intensity 3.

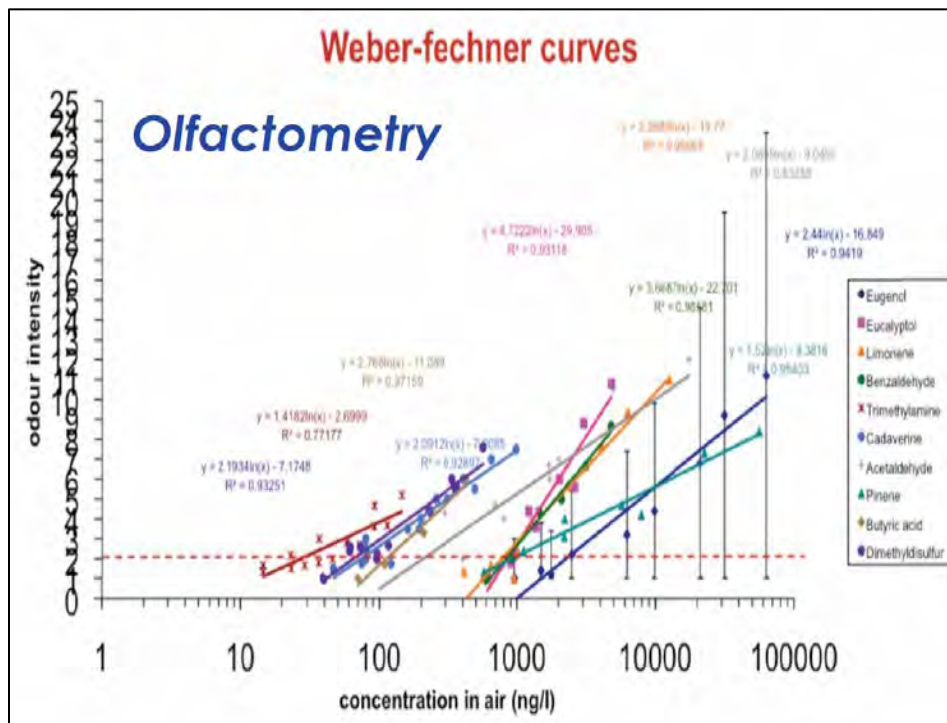

Figure 3-3. Weber-Fechner Curves for Various Constituents

The OPM will be completed at UCLA by a panel of a minimum of four trained panelists. OPM is a modification of Standard Method 2170: The Flavor Profile Analysis Method (APHA 2012). The panelists will identify multiple odor characters in a single sample based upon the Wastewater Odor Wheel and their respective intensities based upon the 7-point Weber-Fechner scales. The Weber-Fechner scale including 0 (no odor), 1 (threshold), 2, 4, 6, 8, 10, and 12 will be used for intensity.

The OPM panelists associate the intensity of each odor using a surrogate sugar-solution scale used for the FPA Method. Levels on the scale are taste-based rather than odor-based yet still afford calibration of either sense. A certain concentration of a taste-based sugar standard is defined as a certain point on the scale and a numerical rating for intensity is assigned.

The OPM results will be presented in a graphic (persistence curve) that shows the log dilution to intensity with the odor character reported for each dilution. Persistence curves will be generated for specific sources as detailed in Tables 2-2, 2-3, and 2-4.

Where only OPM (i.e.; intensity) values are to be measured, UCLA will require either a single 10-liter Teflon bag or four 1-liter Teflon bags. Where OPM + persistence is to be determined, UCLA will require two 10-liter Teflon bags.

### 3.2.1.1 Fecal Odorants

Sampling to analysis time should be kept to no more than 24 hours. Two different sample preparations for analysis by GC/MS will be used:

- 1) Sample preparation for analysis by GC/MS 1. Ten-liter samples will be pulled through a series of 3 impingers with 15 milliliters (mL) dichloromethane in each at flow of 0.5 L/min for 20 minutes (Figure 3-4). Indole and skatole will be detected by GC/MS in the solutions from the first two impingers but not from the third. Accordingly, the solutions from the first two impingers will be transferred to 10-mL Kuderna–Danish concentrator tubes and inserted into a Kontes tube heater (Kontes Corporation, Vineland, New Jersey) to concentrate each sample to 1 mL at 40 degrees Celsius (°C) under a very low surface flow of nitrogen.



Figure 3-4. Set-up of Indole and Skatole Extraction System

One microliter ( $\mu\text{L}$ ) of solution will be injected onto a Varian 450 gas chromatograph (Varian Inc., Palo Alto, California) through an #1177 liquid-injector port followed by a Varian 220 mass spectrometer (SGE Analytical Science, Austin, Texas) with 99.9999 percent helium as the carrier gas.

- 2) Sample preparation for analysis by GC/MS 2. A solid phase microextraction (SPME) method of sample preparation from 10-liter bags will be used as an alternate analysis that is being developed during the quality assurance/quality control (QA/QC) study to improve the analysis.

For either Analysis 1 or 2, the gas chromatograph is equipped with an Agilent DB-5MS column (length 60 meters [m], inner diameter 0.25 millimeter [mm], film thickness 0.25 micrometer [ $\mu\text{m}$ ]) and held at an initial temperature of 65°C with a ramp of 9.5°C/min to 160°C and then 12°C/min to 240°C. The carrier-gas flow rate is 1.0 mL/min through the column. The ion-trap mass spectrometer monitors the primary range of mass-to-charge ratio ( $m/z$ ) units of indole (62-64, 89-91, and 116-119  $m/z$  from 12.00 to 13.00 minutes) and skatole (76-78, 102-104, 129-132  $m/z$  from 13.00 to 14.50 minutes).

### 3.2.1.2 Musty Odorants

Sampling to analysis time should be kept to no more than 24 hours. Two different sample preparations for analysis by GC/MS will be used:

- 1) Sample preparation for analysis by GC/MS 1. From a prepared or sampled Tedlar or Teflon bag, a 100-mL air sample will be collected by ground glass syringe and injected into a gas-adsorbent trap/heat-desorption system (designed by Randy Cook, Lotus Instruments, Long Beach, California). The trap is made out of five layers: 60/80 mesh glass beads, Carboxpack C, Carboxpack B, Carboxieve 569 and Carboxieve 1003. During collection the trap will be maintained at 35°C and to initiate injection will be rapidly heated to 270°C. The purged sample enters the same GC/MS described previously.

- 2) Sample preparation for analysis by GC/MS 2. - An SPME method of sample preparation from 10-liter bags will be used as an alternate analysis that is being developed during the QA/QC study to improve the analysis.

For both Analysis 1 and 2, the gas chromatograph is equipped with an Agilent DB-5MS column (length 60 m, inner diameter 0.25 mm, film thickness 0.25  $\mu\text{m}$ ) and held at an initial 40°C with a ramp of 8°C/min to 88°C, 10°C/min to 100°C, 6°C/min to 156°C, and 10°C/min to 240°C with a hold time of 0.73 min. The carrier-gas flow rate is 1.0 mL/min through the column. The ion-trap MS will be monitored from 45-300 m/z. The ion-trap mass spectrometer monitors the primary range of m/z units of MIB (56-58, 70-72 and 84-86 m/z from 14.50 to 17.00 minutes) and IPMP (108-110, 123-125, 136-138, and 150-153 m/z from 14.40 to 15.00 minutes). Sampling to analysis time should be kept to no more than 6 hours.

### 3.2.2 Laboratory Analyses for Constituent Groupings

ALS Environmental Laboratory will be used to conduct the following analysis by using either Tedlar bag sampling or Sorbent media sampling methods (see Table 3-3 for the list of constituents in each grouping):

- 1) **Reduced Sulfur:** Samples will be tested for 20 other reduced sulfur compounds (including H<sub>2</sub>S) using a gas chromatograph/flame photometric detector following ASTM D5504. The goal of this analysis is to detect the presence, if any, along with the relative concentration of the 20-reduced sulfur species.
- 2) **Carboxylic Acid:** Carboxylic acids (VFAs) will be analyzed using ALS Environmental Method 102, which is a validated in-house method. Samples will be collected by using a 1 L/min sampling pump to pass 100 L through a treated silica gel tube at a flow rate of 1 L/min until 100 L of volume has passed through the tube. The sample tubes will then be sent to ALS and analyzed using a process that involves the derivatization of carboxylic acids, with subsequent analysis by gas chromatography/mass spectrometry. Using the recommended sample volume of 100 liters makes it possible to achieve levels as low as of 2.5 to 5.0 micrograms per cubic meter ( $\mu\text{g}/\text{m}^3$ ).
- 3) **Amines:** Amines will be analyzed using ALS Environmental Method 101. Samples will be collected by using a 1 L/min sampling pump to pass 100 liters through a specially treated sorbent tube that is used to detect the 13 target amine compounds. Sample tubes will then be sent to ALS where they will be desorbed and analyzed by gas chromatography using a nitrogen phosphorus detector. This method allows the detection of target amines present at levels as low as 2  $\mu\text{g}/\text{m}^3$  as long as a minimum of 100 L of volume is passed through the tube.
- 4) **Aldehyde:** Aldehydes will be analyzed in accordance with EPA Method TO-11A. Samples will be collected by using a 1 L/min sampling pump to pass 100 liters through an acidified 2,4-dinitrophenylhydrazine (DNPH)-coated sorbent tube. Tubes will then be sent to ALS for analysis via reverse phase high-performance liquid chromatography with ultraviolet detection.
- 5) **Ammonia:** Ammonia will be collected by using a 1 L/min sampling pump to pass 100 liters through a sulfuric acid-coated Anasorb-747 (carbon bead) tube. Tubes will then be sent to ALS where they will be analyzed using the OSHA ID-188 method, which utilizes an ion-specific electrode to detect ammonia. Draeger tubes may be utilized instead.
- 6) **VOCs:** VOCs will be analyzed following EPA Method TO-17. Samples will be collected by using a 100 milliliters per minute sampling pump to pass four liters of odorous air through a carbotap 300 tube. Tubes will then be sent to the laboratory where they will be thermally desorbed and analyzed by gas chromatography/mass spectrometry. The TO-17 method identifies up to 61 standard compounds shown in Table 3-4. In addition to the standard list, the tubes will also be analyzed for up to 20 compounds in the National Institute of Standards and Technology library that includes over 120,000 compounds. These compounds will be detected using spectral comparison and are considered tentatively identified

compounds. Included in this library of compounds are common wastewater odors Skatole and Indole (both fecal odorants).

Table 3-3. List of Sub-compounds for Selected Tests

Amines	Aldehydes	Carboxylic Acids	Sulfur Compounds
Butylamine	Formaldehyde	Acetic Acid	n-Butyl mercaptan
s-Butylamine	Acetaldehyde	Butanoic acid (Butyric acid)	tert-Butyl mercaptan
t-Butylamine	Propionaldehyde	Heptanoic acid	Carbon disulfide
Diethylamine	Crotonaldehyde, Total	Hexanoic acid	Carbonyl sulfide
Diisopropylamine	Butyraldehyde	2-Methyl butanoic acid	Diethyl Disulfide
Dimethylamine	Benzaldehyde	Methyl butanoic acid (Isovaleric acid)	Diethyl Sulfide
Dipropylamine	Isovaleraldehyde	Methyl propanoic acid (Isobutyric acid)	Dimethyl disulfide
Ethylamine	Valeraldehyde	2-Methylpentanoic acid	Dimethyl sulfide
Isobutylamine	o-Tolualdehyde	3-Methylpentanoic acid	2,5-Dimethylthiophene
Isopropylamine	m,p-Tolualdehyde	4-Methylpentanoic acid	Ethyl mercaptan
Propylamine	n-Hexaldehyde	Octanoic acid	Ethyl methyl sulfide
Triethylamine	2,5-Dimethylbenzaldehyde	Pentanoic acid (Valeric acid)	2-Ethylthiophene
Trimethylamine		Propanoic acid	Hydrogen sulfide
		2-Ethyl hexanoic acid	Isobutyl mercaptan
		Nonanoic acid	Isopropyl mercaptan
			Methyl mercaptan
			3-Methylthiophene
			n-Propyl mercaptan
			Tetrahydrothiophene
			Thiophene

Table 3-4. List of 61 Standard VOCs Using Method TO-17

Method TO-17- VOCs Standard Compound List		
Dichlorodifluoromethane (CFC 12)	Chloroform	2-Hexanone
Chloromethane	Tetrahydrofuran (THF)	Dibromochloromethane
1,2-Dichloro-1,1,2,2-tetrafluoroethane (CFC 114)	1,2-Dichloroethane	1,2-Dibromoethane
Vinyl Chloride	1,1,1-Trichloroethane	n-Octane
1,3-Butadiene	Benzene	Tetrachloroethene
Chloroethane	Carbon Tetrachloride	Chlorobenzene
Ethanol	Cyclohexane	Ethylbenzene
Acetonitrile	1,2-Dichloropropane	m,p-Xylenes
Acetone	Bromodichloromethane	Bromoform

Method TO-17- VOCs Standard Compound List		
Trichlorofluoromethane	Trichloroethene	Styrene
2-Propanol (Isopropyl Alcohol)	1,4-Dioxane	o-Xylene
1,1-Dichloroethene	2,2,4-Trimethylpentane (Isooctane)	1,1,2,2-Tetrachloroethane
Methylene Chloride	n-Heptane	Cumene
Trichlorotrifluoroethane	cis-1,3-Dichloropropene	1,3,5-Trimethylbenzene
Carbon Disulfide	4-Methyl-2-pentanone	1,2,4-Trimethylbenzene
trans-1,2-Dichloroethene	trans-1,3-Dichloropropene	1,3-Dichlorobenzene
1,1-Dichloroethane	1,1,2-Trichloroethane	1,4-Dichlorobenzene
Methyl tert-Butyl Ether	Toluene	1,2-Dichlorobenzene
2-Butanone (MEK)	Hexachlorobutadiene	1,2-Dibromo-3-chloropropane
cis-1,2-Dichloroethene	Naphthalene	
n-Hexane	1,2,4-Trichlorobenzene	

### 3.2.3 Olfactometry

BAAQMD Regulation 7, Section 7-400 describes the District's in-house analysis methodology and procedure for completing odor panel analysis. A major difference between the Section 7-400 methodology and the industry standard ASTM E679-04 standard is the presentation rate. Regulation 7, Section 7-400 uses a presentation rate of 14 L/min while ASTM E679-04 uses 20 L/min. Based on published research results of different presentation rates, a presentation rate of 20 L/min has been proven to provide best accurate and reproducible results. Therefore, the ASTM E679-04 methodology is recommended for this effort.

Odor concentration by olfactometry will follow ASTM E679-04 Standard of Practice with a presentation rate of 20 L/min (per EN 13725) using St. Croix Sensory, Inc.'s odor panel analyses. Samples will be collected in 10-liter Tedlar bags. Results will determine the magnitude of odor emissions from each source and determine the relative offensiveness of odors from each source. Odor panel analysis will report odor concentrations expressed as D/T, recognition threshold, odor offensiveness as measured by hedonic tone (the degree to which an odor is perceived as pleasant or unpleasant), and odor character descriptors.

The odor samples are diluted to below olfactory detection limits and then introduced to a gas delivery system. A panel of eight members trained in odor response serves as the odor "detector." Panel members are asked to smell air samples delivered to one of three nose cones (the other nose cones have clean air), one of which has the diluted sample. The concentrations of sample are increased until one-half of the odor panel members can detect the odor. The odor measurement is concluded when detection by four of the eight panel members is recorded. The odor concentration is expressed as the number of dilutions that are required for one-half of the panel members to record detection: D/T level.

Odor intensity is determined in accordance with ASTM Method E544-104. ASTM Method E544 is the standard reference method most widely used for quantifying odor intensity. This method references the odor intensity of an odor sample to eight concentrations of a reference odorant, n-butyl alcohol (butanol), ranging between approximately 15 and 200 ppmV in air. Butanol has a unique ability to provide varying intensities with concentrations that are easily identifiable to most populations. Thus, the intensity level (or sensation) of any odorous substance can be compared to this constant rating system. The butanol scale concentrations represent different intensities ranging from slightly above threshold (1) to very strong (8). Reported intensity values are related to known concentrations of n-butanol in air or water. The higher the reported concentration is, the greater the perceived intensity of the odor. Although odor intensity results are not used in the modeling of odor

emission sources, the relative intensity levels for different D/T concentrations will be compared for each process area odor type.

### 3.3 Field Surveys/Measurements

#### 3.3.1 Olfactometer

Jacobs will deploy a two-person team for a field odor assessment. The team will use a field olfactometer that will allow the quantification of odors in the field. The field olfactometer uses a similar methodology as an olfactometer used in the lab to quantify odors according to the standard ASTM method (ASTM E679) and is designed to provide accurate in-field odor measurement of ambient air. Field olfactometry will be completed using the SM100. Operation of the SM100 will be completed in the presence of a trained odor control engineer.

**Scentroid SM100**— In-field olfactometry will utilize the Scentroid SM100 Olfactometer. The unit measures odor in odor units per cubic meter (OU/m<sup>3</sup>) (D/T). The unit measurement range is 2 to 15,000 OU/m<sup>3</sup> (D/T).

The objectives of field odor assessment are:

- Quantify the relative odor impact in the neighboring communities
- Quantify the relative odor strength of the different odors emitted from a facility

The team will walk the areas in neighboring communities, the perimeter of each facility, and the surrounding area. Field odor monitoring will be preferably performed during sensitive periods of the day when the facilities are operating regularly. The field effort will consist of the following steps:

- 1) Team members will walk around in the targeted area.
- 2) Team members will use their noses to detect any odors.
- 3) When odor is detected and confirmed by a second team member, the following equipment will be used:
  - a) Wind meter (to collect wind direction and wind speed data).
  - b) Scentroid SM100.
- 4) Each time odor is detected, the following field parameters will be recorded in the field form provided in Appendix A:
  - a) Location and time.
  - b) Wind direction and velocity.
  - c) Weather conditions: Sunny (1), Partly Cloudy (2), Mostly Cloudy (3), Overcast (4), Hazy (5).
  - d) Precipitation: None (1), Fog (2), Light Rain (3), Rain (4).
  - e) Odor strength: Field olfactometry with the Scentroid SM100 to quantify odor strength at specific locations. The instrument is designed for measuring and quantifying odor strength in the ambient air.
  - f) Odor characterization:
    - i. Odor descriptors: What does it smell like? For example, earthy, musty, metallic, ammonia, sour, using an odor descriptor wheel as a referencing vocabulary for odor descriptors.
    - ii. Intensity: How strong is the smell? Not Detectable (0), Very Weak (1), Weak (2), Distinct (3), Strong (4), Very Strong (5), Extremely Strong (6).
    - iii. Hedonic Tone: How pleasant is the smell? Pleasant (1), Neutral (0), Unpleasant (-1), Revolting (-2), Nauseating (-3).

Specific walking routes by individual team members will be conducted randomly to document locations with and without any odor to be correlated with observed meteorological conditions (data obtained from the portable wind meter and will be compared to the data obtained from the closest Bureau of Meteorology meteorological station). Individual team members will walk in the target area as well as upwind of the different sources at the facility from certain sampling locations to determine where else odors could be detected, where odors would possibly originate from, and to correlate them with observed conditions.

### **3.3.2 Meteorological Data Collection**

Prior to completing an olfactometer survey, a portable weather station, such as the Davis Vantage PRO2, will be used to collect meteorological data including temperature, wind direction, wind velocity, and wind gust. The weather station will be set up in an area where the wind is unobstructed and as close to the location of survey as possible. The unit will be mounted 4 to 6 feet above the ground using an appropriate weather station tripod. In addition, observational data should be recorded for weather condition (sunny, partly cloudy, and similar) and precipitation (fog, rain, and similar). This information will be recorded in the field form provided in Appendix A. Newby Island and San Jose Air District Network weather stations may be utilized as data verification sources.

### **3.3.3 Field Hydrogen Sulfide and Ammonia**

Field measurements for H<sub>2</sub>S and ammonia will be conducted using Gastec or Draeger colorimetric tubes and handheld Jerome hydrogen sulfide meters. This type of field real-time sampling will be completed during each sampling event at each sampling location. This real-time field data will be used to back up and cross check more sophisticated laboratory analysis that will be conducted on odorous air bag samples sent to the laboratory. It should be noted that some degradation of odors can occur within the first 24 hours after bag collection. By providing real-time field measurements, more accurate levels of certain odors can be achieved.

**Colorimetric tubes:** The tube is interfaced to the testing point of interest, and a handpump calibrated to pull either 50 cubic centimeters or 100 cm to draw the air sample through the tube. The advance of the color change on the calibrated tube barrel is this indication of the compound (such as H<sub>2</sub>S, ammonia, and similar) concentration.

**Jerome 631-X handheld analyzer:** This instrument is factory calibrated and has a working range of 1 to 50,000 ppbV. It will detect other reduced sulfur compounds at about 10 percent of the sensitivity compared to H<sub>2</sub>S.

### **3.3.4 Continuous Hydrogen Sulfide Monitoring**

OdaLog continuous data logging units will be deployed in specific locations to measure H<sub>2</sub>S levels over a continuous time span. Duration of logging will range between 1 week and 2 weeks depending on the location, and readings will be taken and logged once every 10 minutes. This continuous data logging will capture diurnal trends and assist in determining best time of the day to obtain grab samples or to help establish diurnal odor emission rates.

### **3.3.5 Pressure/Flow Measurements**

For pressure and airflow measurements, a hot wire anemometer such as calibrated TSI VelociCalc Plus or similar instrument shall be used. Measurement methodology utilized will comply with ST-18, Stack Traverse Point Determination (BAAQMD 1982).



### 3.4 Shipping & Lab Coordination

Air samples and sorbent media tubes will be collected and shipped overnight express, for next-day analysis, to St. Croix Sensory, Montrose, ALS, and UCLA. St. Croix Sensory conducts odor panel analysis, Montrose the PTR-MS and FTIR analyses, while ALS conducts a variety of analytical procedures to quantitatively measure sulfur-related compounds, along with other compounds such as carboxylic acids (volatile fatty acids [VFAs]), amines, VOCs, and aldehydes. MH3 Corporation, which operates their laboratory out of UCLA, conducts OPM analysis as well as chemical analysis of musty and fecal odorants.

Bag samples collected for the various lab analyses will be packaged in cardboard boxes to be shipped to each lab. The boxes will be large enough to fit several samples and preferably to the point where the box is tight-fit. If samples are shipped via aircraft, sample bags will expand during shipment; therefore, bags will not be more than 75 percent full.

Samples will be shipped using commercial shippers allowing the sample hold time of 24 hours to be met. Ambient air bag samples will be shipped (next day or priority overnight) for next-day delivery and analysis. If samples are collected during the morning, samples will be shipped priority overnight to ensure delivery for next-morning delivery and meet the 24-hour hold time requirement. Shipping receipts with tracking number will be retained by the field crew.

Following shipment, each lab should be contacted so that they are aware of the samples and can check shipment arrivals the next day.

Bag samples for OPM and Persistency Curve analysis will be shipped overnight to:

UCLA Medical Center  
Medical Receiving  
650 Charles E. Young Drive South  
CHS 61-295, Dept. Env. Health Sciences  
Los Angeles. CA 90095  
Contact 1: Dr. Mel Suffet, [msuffet@ucla.edu](mailto:msuffet@ucla.edu)  
Contact 2: Yubin Zhou, (310) 880-2951

Bag samples for odor panel analysis will be shipped priority overnight to:

St. Croix Sensory, Inc.  
1150 Stillwater Blvd. N.  
Stillwater, MN 55082  
Contact: Donna McGinley  
Phone: (651) 439-0177, x11  
Email: [donna@fivesenses.com](mailto:donna@fivesenses.com)

Bag samples for total reduced sulfur and VOC analysis will be shipped for next-day delivery to ALS. In addition, sorption tube samples for carboxylic acid, amine/ammonia and reduced nitrogen analysis will be shipped ground to ALS. Contact information is:

ALS  
2655 Park Center Drive, Suite A  
Simi Valley, CA 93065  
Contact: Kate Kaneko  
Phone: (805) 526-7161  
Email: [Kate.Kaneko@alsglobal.com](mailto:Kate.Kaneko@alsglobal.com)

Bag samples collected during the first sampling event for PTR-MS and FTIR analysis will be shipped overnight to:

Montrose Environmental Group  
951 Old Rand Rd # 106,  
Wauconda, IL 60084  
Contact: Dr. Steven Yuchs and Peter Zemek  
Phone: (847) 487-1580 (Steven) and (919) 522-2032 (Peter)  
Email: [pzemek@montrose-env.com](mailto:pzemek@montrose-env.com) (Peter)

Prior to sample collection and shipment, each of the labs should be alerted of upcoming sampling. ALS and St. Croix generally have lab availability to receive and analyze over 10 samples per day, however, these labs do have periods throughout the year where sample volume is high and their labs can become inundated. MH3 has lab limitations and generally cannot accept over three samples per day depending on the analyses being completed. Therefore, sample collection should be planned so that daily samples to MH3 is limited to three samples. ALS, St. Croix and MH3 should be contacted one week ahead of sampling to confirm lab availability. Additionally, the labs should be contacted after they are dropped off at the appropriate shipping center to confirm the number of samples being shipped and advise on when the samples may be received. Labs should also be contacted the following day to confirm samples were received.

## 4. Field Procedures

Each sampling event will occur over a period one week to collect samples from all three facilities. The first day will include logistical setup and installation of continuous H<sub>2</sub>S monitoring equipment (OdaLogs) followed by sample collection. The intent is to collect all samples for shipping prior to Friday to avoid laboratory analysis over the weekend. Sampling will take place between the hours of 7:00 a.m. and 4:00 p.m. but may continue into the evening if needed.

Following sample collection, olfactometric surveying will be completed in the community downwind of the facilities, as outlined in Section 3.2. This will occur within one week of sample collection, while the meteorological conditions are monitored and recorded. Similar to sample collection, surveying will be completed between the hours of 7:00 a.m. and 4:00 p.m. but may continue into the evening if needed.

Weather data will be collected during the sampling event from the different weather stations available, which include the local Newby weather stations as well as regional weather stations such as at the nearby SJC airport.

During the sampling events, a portable weather station will be used to measure local wind conditions as part of the field olfactometry assessment.

### 4.1 Field Equipment

All sampling media (prepared per method specifications) including Tedlar bags, EPA flux chamber, and sorption tubes will be provided by the appropriate laboratory. Jacobs will supply all other sampling equipment and expendable supplies. The necessary field equipment and expendable supplies for the proposed field testing are as follows:

- EPA flux chamber per EPA design, including stainless steel Swagelok fittings
- SCAQMD Rule 1133 high air flow flux chamber (if available)
- Vacuum chamber with vacuum pump and rotameter (0- to 5-liter per minute)
- Apex2 IS Plus Sampling Pump (1 liter per minute). Procure six (four will be in use at any one time)
- Brass, two-stage regulator for bottled nitrogen (CGA 590 fitting for nitrogen and 1/4-inch Swagelok (male) adapter fitting)
- 10-foot, 1/4-inch Teflon line with female fittings and extra 50-foot length of tubing
- 25-foot, 1/4-inch Teflon air inlet/outlet support line for sweep gas with rotameter
- Large size plastic support cooler
- Set of miscellaneous hand-tools including an adjustable crescent wrench for the CGA 580 regulator fitting, small adjustable crescent wrench for the 1/4-inch Swagelok fittings, assorted medium- and small-size screw drivers
- Decontamination supplies, including Alconox soap, paper towels, and wash water
- Ultra High Purity Nitrogen bottle (size 150)
- Helium tracer gas (if high air flow flux chamber used)
- Flotation device for flux chamber
- Ropes for suspension of flux chamber and obtaining any liquid samples
- Tedlar bags (1 liter for reduced sulfur analysis and 10 liter for odor panel analysis),

- Teflon bags (10 liter for OPM analysis)
- Sample shipping containers
- Sorption Tubes (various)
- OdaLog Units (0 to 200 ppmV and two 0 to 2 ppmV units)
- Jerome 631-X analyzer
- Draeger Tubes (various) and handpump
- Portable weather station with mounting device (for example Davis Vantage PRO2)
- Field Olfactometer (for example Scentroid SM100)
- At least 5 feet of 3/16" ID thick wall Silicone tubing to attach Teflon® tubing to equipment
- At least 100' of spare Teflon® tubing. This can be reused when rinsed with DI water and flushed with UHP nitrogen
- ¼" Swage (SST or Teflon®) fittings (tees/crosses particularly) to manifold multiple sample lines for simultaneous sampling from one source
- Small portable table (and chair) to put all the sampling trains on so they are out of the dirt
- A 100 ml syringe to sample the land fill gas line. This can be cleaned and reused using DI water and flushed with UHP nitrogen
- Wash bottle with DI water
- Calibration rotometers for the sampling pumps (1 liter/min)
- Thermocouple to measure temperatures when sampling
- Hot wire anemometer for air flow measurements
- Camera
- Personal protective equipment (PPE) (hard hats, safety vests, safety glasses, gloves, steel toe boots, face mask)

### 4.2 Quality Assurance / Quality Control

The following is a list of key field quality control items that should be followed in the field:

- Prior to sample collection, inspect each Tedlar and Teflon bag to ensure there are no rips that may allow the sample to leak out or non-sample air to leak in.
- Prior to sample collection, prime the sample bag by running sample air through the sample line into the sample bag for preconditioning. Partially fill the bag, then expel the bag contents prior to taking the sample to be sent to the lab. This also allows any non-sample air to be removed from the sample line.
- Clean sample lines should be used for each odor source and sample lines should be cleaned after each sampling event. Sampling lines can be cleaned by running warm water (no soap) through the sample line for a few minutes and then dried using odor-free air.
- Following sample collection, ensure the sample bag cap is screwed on tightly to ensure the sample air does not leak out of the bag.
- Prior to shipping the samples, examine the filled sample bags to ensure that each bag is approximately 3/4 full as bags will expand at altitude when delivered via aircraft. A bag that is more than 3/4 full is at risk of popping from over-expansion.

- Field log forms should be filled out while collecting samples or conducting field olfactometry surveys, to ensure the proper information is noted. All fields should be completed, and where applicable, additional notes should be made.
- Photos will be made during the sample collection to document time and location of sample collection.

The quality control activities scheduled for the field equipment are summarized in Table 4-1.

Table 4-1. Summary of Field Quality Control Information

Sampling Method	Activity	Frequency	Criteria
Sample Pumps	Rotometer Single-Point Calibration	Before and after each sample collection	None
Flux Chamber	Rotometer Single-Point Calibration	Annual	None
Scentroid SM100	Dilution Calibration	Annual	Define dilution factor for each dial setting
Portable weather station	Factory Calibration	Annual	Manufacturer's specifications
Jerome Meter	Factory Calibration	Annual	Manufacturer's specifications

#### 4.2.1 Chain of Custody Procedures

All samples will be recorded using a chain-of-custody sheet provided by the sampling team or laboratories. A copy of the chain-of-custody will be kept with the field samplers, and a copy will be shipped to the laboratory along with the samples. The laboratory will review the chain-of-custody, make any necessary annotations, and return a copy of the chain-of-custody with the reporting of the laboratory results.

#### 4.3 Health and Safety

Jacobs has prepared a Project Health Safety and Environment Plan (PHSEP) for its staff, which will be followed, along with any site-specific health and safety requirement enforced by each of the facilities. Prior to going onsite, all Jacobs staff will review and sign the safety plan. A record of these signatures will be stored in the project folder. The Jacobs-specific PHSEP can be found in Appendix B.

Prior to beginning sampling at each facility, Jacobs and other sample staff will meet with the appropriate facility staff to hold a safety meeting. The focus of this meeting will be to discuss any facility-specific requirements, PPE required, general safety protocol at the site, including evacuation procedure, and any hazards at the facility that the team should be aware of. As appropriate, sampling staff will be accompanied by staff from each facility.

Safety protocols will be developed and implemented related to safe sample handling and specifically handling and shipping of samples containing methane gas.

To reduce risk of exposure to COVID-19, and comply with local regulations, social distancing will be followed when possible. All sampling staff will wear masks and gloves to limit exposure and contact with others. Disinfected spray or gel will be used to regularly disinfect any equipment or gloves during the day. If staff are feeling ill or feel that they have come in contact with someone who may have COVID-19, they should alert their appropriate team immediately.

## 5. Communication

Contact information for BAAQMD, Jacobs, Montrose, and each of the facilities are provided in Table 5-1.

Table 5-1. Project Contacts

Organization	Name	Phone	Email	Comments
BAAQMD	Jerry Bovee		jbovee@baaqmd.gov	BAAQMD Program Manager
BAAQMD				
BAAQMD				
Jacobs	Jay Witherspoon		Jay.Witherspoon@jacobs.com	Project Manager
Jacobs	Mia Lindsey	+1.707.590.1542	Mia.Lindsey@jacobs.com	Dep. Project Manager
Jacobs	Bart Kraakman	+44-7240722550	Bart.Kraakman@jacobs.com	Technical Director
Jacobs	Scott Cowden		Scott.Cowden@jacobs.com	Technical Lead
Jacobs	Giuseppe Tomasino	+1.415.728.0637	Giuseppe.Tomasino@jacobs.com	Field Sampling Lead
Jacobs	Niranjana Rajagopalan		Niranjana.Rajagopalan@jacobs.com	Field Sampler
Montrose	Peter Zemek	+1.919.522.2032	pzemek@montrose-env.com	Project Manager
Montrose	[secondary contact]			Secondary Contact
RWF	Jason Nettleton		Jason.Nettleton@sanjoseca.gov	Primary Contact
RWF	[secondary contact]			
Newby Island	Rachelle Huber			Primary Contact
Newby Island	[secondary contact]			
ZWED	John Pena		jpena@zwedc.com	Primary Contact
ZWED	[secondary contact]			
MH3	Mel Suffet	-	msuffet@g.ucla.edu	Odor Profile Method Expert
EMC	Tom Card	+1.360.802.5540	trcard@EnvManCon.com	On-site Sampling Team

## 6. References

- American Public Health Association (APHA). 2012. "2170 Flavor Profile Analysis." *Standard Methods For the Examination of Water and Wastewater*. <https://www.standardmethods.org/doi/abs/10.2105/SMWW.2882.021>.
- Bay Area Air Quality Management District (BAAQMD). 1982. *Manual of Procedures Volume IV, Source Test Policy and Procedures*.
- BAAQMD. 1982. *Source Test Method ST-08, Dimethylsulfide*.
- BAAQMD. 1982. *Source Test Method ST-11, Mercaptans*.
- BAAQMD. 1982. *Source Test Method ST-12, Collection of Odorous Samples*.
- BAAQMD. 1982. *Source Test Method ST-21, Total Reduced Sulfur*.
- BAAQMD. 1982. *Source Test Method ST-22, Trimethylamine*.
- BAAQMD. 1982. *Source Test Procedure ST-18, Stack Traverse Point Determination*.
- CH2M Hill. 2012. *Odor Source Characterization Sampling Plan Rev. 5*.
- CH2M Hill. 2015. *Odor and Corrosion Control Study*.
- South Coast Air Quality Management District (SCAQMD). 2006. *Determination of Ammonia Emissions from Stationary Sources*.
- Suffet, I.H. 2016. *Analytical Method Quality Assurance Study for Tedlar and Teflon Sampling Bags for CH2M Hill*.
- U.S. Environmental Protection Agency (EPA). 2012. *Emission Testing Methodology for Air Pollution*.
- U.S. EPA. 1999. Environmental Restoration Division Standard Operating Procedure 1.11, *Soil Surface Flux Monitoring of Gaseous Emission*.
- U.S. EPA. 1999. *Compendium Method TO-05, Determination of Aldehydes and Ketones in Ambient Air Using High Performance Liquid Chromatography (HPLC)*.
- U.S. EPA. 1999. *Compendium Method TO-11A, Determination of Formaldehyde in Ambient Air Using Adsorbent Cartridge Followed by High Performance Liquid Chromatography (HPLC)*.
- U.S. EPA. 1999. *Compendium Method TO-17, Determination of Volatile Organic Compounds in Ambient Air Using Active Sampling Onto Sorbent Tubes*.
- U.S. EPA. 1999. *Compendium Method TO-15, Determination of Volatile Organic Compounds (VOCs) In Air Collected in Specially-Prepared Canisters And Analyzed By Gas Chromatography/Mass Spectrometry (GC/MS)*.
- U.S. EPA. 1999. *Compendium Method TO-14A, Determination Of Volatile Organic Compounds (VOCs) In Ambient Air Using Specially Prepared Canisters With Subsequent Analysis By Gas Chromatography*.
- U.S. EPA. 1997. *Procedure for Collection and Analysis of Ammonia in Stationary Sources*.

U.S. EPA. 1986. "Measurement of Gaseous Emission Rates from Land Surfaces Using an Emission Isolation Flux Chamber." *User's Guide*.



**Appendix A**  
**Field Log Form**



**Appendix B**  
**Health & Safety Plan**

**Appendix B**  
**Laboratory Results**

## Appendix B. Laboratory Results

### B.1 Sampling Event 1

Table B-1. Odor Characteristics and Intensities of Each Odor Characteristic Observed

Sample Number	Odor Profile Method (OPM)- Odor Characteristics and Intensities	Note	Field Notes	Sensory GC compared to OPM
<b>ZWED</b>				
101 - Biofilter 1	Rotten veg 2.0±2.8, fecal 4.0±1.6	Important source; open steel tank/wood shredding on top	--	Also musty
102 - Interior Space	Rancid 10.0±1.6, sweet 10.0±1.6	Important source	Very rancid	Also musty
104 - Upwind	Musty 1.0±1.2	--	No odor	--
<b>RWF</b>				
201 - East Primaries	Rotten veg 5.0±5.8, fecal 4.0±4.9	Important source	H2S	Also rotten eggs
202 - Bioreactors	Fecal 4.0±0.0, odor note: rotten veg	Mixing zone sample/do outside mixing zone	On 2 min /10 min	Also rotten eggs
203 - Drying Beds	odor note: rotten veg, medicinal	--	No odor	x
205 - Upwind	No odor reported	--	--	x
<b>Newby</b>				
301 - Compost Piles	Musty 2.0±2.3; medicinal 1.0±1.2	Musty source – bark on top	Pile 11- control cover-odor not offensive	x
302 - Landfill Working Face	Rancid 7.5±2.5, sweet 7.5±2.5;	Important source	Mild odor	Also musty & fruity
303 - Cake Stockpile	Musty 3.0±2.6; odor note: sweet rancid, chlorine	Musty source	--	x
304 - Landfill Gas	Fecal 5.0±5.8, rotten veg 5.5±4.4; odor note: sweet rancid, medicinal	Important source	--	Also rotten eggs
<b>Miscellaneous</b>				
401 – Landfill Leachate	Fecal 7.5±3.4, rancid 1.5±1.9, sweet 1.5±1.9;	Important source	--	Also musty
402 – MRF	Odor note: fecal	--	Mild odor	x

Sample Number	Odor Profile Method (OPM)- Odor Characteristics and Intensities	Note	Field Notes	Sensory GC compared to OPM
403 – NIRRP Upwind	No odor reported	--	--	x
404 – SJWWTF Downwind	No odor reported	--	Low NW- --Heat	x
405 – ZWED Downwind	Rancid 4.0±2.8, sweet 2.5+1.0; odor note: rotten veg	Important source	Mod NW- --Mod Odor	Also musty
406 – Milpitas Pump Station	Odor note: rotten egg	--	Mod NW-- -Sl Odor	x
407 – Newby Island Downwind	Odor note: musty	SE corner?	Mod NW-- -Sl Odor	x

Notes:

Panel Method: Odor Profile Method – Completed by MH3 Corporation

Analysis Temperature: Room Temperature – All about 72°F

Odor Panel: Dr. I. Suffet - Odor Panel Leader - Total odor panel of 4

**Table B-2. Field Odor Measurements at and around ZWED, October 19, 2020**

Location	Time	Weather Conditions				Odor Present? (Yes/No)	OS <sup>7</sup>	D/T in the field	A <sup>6</sup>	Odor Character <sup>3</sup>	IS (0-6) <sup>4</sup>	HT (1to-3) <sup>5</sup>
		Wind Direction	Wind Velocity (mph)	Sunny/ Cloudy <sup>1</sup>	Rain <sup>2</sup>							
1- Warm Springs Blvd	8:10 AM	W	0	1	1	Y	N/A		AP	Earthy	0	0
		W	0	1	1	Y	N/A		EA	" "	0	0
2- Scott Creek Road	8:32 AM	SE	2	1	1	Y	2	119	AP	Onion	2	0
		S	2	1	1	Y	2	119	EA	Onion/ Vinegar	2	0
3- Milmont Dr	9:00 AM	S/SE	3	1	1	Y	5	28	AP	Onion/ Garlic	3	0
		S/SE	4	1	1	Y	5-6	24	EA	Chlorine/ Chemical	3	0
4- Tramway Dr	9:22 AM	S/SE	3	1	1	Y	>15	2	AP	Vegetable/ Garlic	1	0
		S/SE	3	1	1	Y	>15	2	EA	--	1	0
5- Marilyn Dr	9:45 AM	S/SE	1-2	1	1	N	N/A		AP	N/A	0	0
		S/SE	1-2	1	1	N	N/A		EA	N/A	0	0
6- Zanker Rd	10:05 AM	N	1	1	1	Y	>15	2	EA	Gasoline	2	0
		N	1-2	1	1	Y	>15	2	AP	Gasoline/ Chemical	1	0
7- Renaissance Dr	10:17 AM	SW	1-2	1	1	Y	3	57	EA	Floral	1	0
		SW	1-2	1	1	Y	>15	2	AP	Floral	1	0
8- RWF nearby	10:35 AM	NE	1	1	1	Y	5-6	24	AP	Paint/ Chemical	3	-1
		NE	1	1	1	Y	2-3	88	EA	Chemical	3	-1

Location	Time	Weather Conditions				Odor Present? (Yes/No)	OS <sup>7</sup>	D/T in the field	A <sup>6</sup>	Odor Character <sup>3</sup>	IS (0-6) <sup>4</sup>	HT (1to-3) <sup>5</sup>
		Wind Direction	Wind Velocity (mph)	Sunny/ Cloudy <sup>1</sup>	Rain <sup>2</sup>							
9- ZWED nearby	10:58 AM	SW	3	1	1	Y	8	11	AP	Rotten Egg/ Sulfur	4	-1
		SW	3	1	1	Y	6	20	EA	Chemical/ Sulfur	3	-1
10- ZWED/ RWF Upwind	11:17 AM	SW	5	1	1	Y	5	28	AP	Lake water/ Marsh	3	0
		SW	6	1	1	Y	8	11	EA	Landfill Leachate	3	-1
11- RWF Lagoons nearby	11:40 AM	SE	4	1	1	Y	3	57	AP	Chemical/ Paint	2	0
		SE	4	1	1	Y	>15	<2	EA	Chemical	1	0
12- Main Lift Station nearby	11:56 AM	SE	2	1	1	Y	4	39	AP	Chemical	2	0
		SE	2	1	1	Y	7-8	12	EA	Chemical	3	-1/0
13- NIRRP nearby	12:11 PM	N/NW	2	1	1	Y	8	11	AP	Landfill/ Paint	4	-1
		N/NW	2	1	1	Y	8	11	EA	Landfill/ Garbage	6	-3
Interior ZWED	4:20 PM	N/A	N/A	N/A	N/A	Y	3	720	AP	Garbage	6	-3
		N/A	N/A	N/A	N/A	Y	2	1033	EA	Garbage	6	-2
ZWED nearby	4:40 PM	SE	3	1	1	Y	15	138	EA	Garbage	3	-1
		SE	3	1	1	Y	15	138	AP	Garbage	3	-1
ZWED Pressure Relief	5:00 PM	SE	2	1	1	Y	5	430	AP	Garbage	4	-1
		SE	2	1	1	Y	6	356	EA	Garbage	3	-1



Location	Time	Weather Conditions				Odor Present? (Yes/No)	OS <sup>7</sup>	D/T in the field	A <sup>6</sup>	Odor Character <sup>3</sup>	IS (0-6) <sup>4</sup>	HT (1to-3) <sup>5</sup>
		Wind Direction	Wind Velocity (mph)	Sunny/ Cloudy <sup>1</sup>	Rain <sup>2</sup>							
ZWED Biofilter 1	5:00 PM	SW	1	1	1	Y	2	1033	AP	Rancid/ Mildew	6	-3
		SW	1	1	1	Y	2	1033	EA	Garbage/ Decay	6	-3

- 1. Weather Conditions: Sunny (1), partly cloudy (2), mostly cloudy (3), overcast (4), hazy (5)
  - 2. Precipitation: None (1), fog (2), light rain (3), rain (4)
  - 3. Odor Character: e.g. earthy, musty, rotten egg, urine, sour, ammonia, sweet, chemical, fishy, seaweed, agricultural, superphosphate, and other (please state)
  - 4. Odor Intensity: Not Detectable (0), Very Weak (1), Weak (2), Distinct (3), Strong (4), Very Strong (5), Extremely Strong (6)
  - 5. Hedonic Tone: Pleasant (1), Neutral (0), unpleasant (-1), revolting (-2), nauseating (-3)
  - 6. Assessor: Initials of person conducting assessment.
  - 7. Odor Strength (field olfactometer). Measured reading from Scentroid.SM100
- \*Note: N/A = non-detect on the Scentroid SM100 with the U-2 plate

**Table B-3. Field Odor Measurements at and around RWF, October 20, 2020**

Location	Time	Field Conditions		Weather Conditions		Odor Present? (Yes/No)	OS <sup>7</sup>	D/T in the field	A <sup>6</sup>	Odor Character <sup>3</sup>	IS (0-6) <sup>4</sup>	HT (1 to-3) <sup>5</sup>
		Wind Direction	Wind Velocity (mph)	Sunny/ Cloudy <sup>1</sup>	Rain <sup>2</sup>							
1- Warm Springs Blvd	7:56 AM	N/A	0	1	1	Yes	N/A		AP	Floral	1	0
	7:56 AM	N/A	0	1	1	Yes	N/A		EA	Grass/ Floral	2	1
2- Scott Creek Road	8:19 AM	N/A	0	1	1	Yes	N/A		AP	Onion/ Vegetable	1	0
	8:19 AM	N/A	0	1	1	Yes	13	4.5	EA	Vinegar/ Onion	1	0
3- Milmont Dr	8:37 AM	SE	3	1	1	Yes	N/A		AP	Onion/ Vegetable ??	1	0
	8:37 AM	SE	3	1	1	Yes	N/A		EA	N/A	0	0
4- Tramway Dr	9:38 AM	S-SE	1	1	1	NO	N/A		AP	N/A	0	0
	9:38 AM	S-SE	1	1	1	NO	N/A		EA	N/A	0	0
5- Marilyn Dr	9:50 AM	SE	2	1	1	Yes	8	11	AP	Seaweed/Veg etable	1	-1
	9:50 AM	SE	2	1	1	Yes	7	13	EA	Algae	1	0
6- Zanker Rd	10:14 AM	S	0-1	1	1	NO	N/A		AP	Very weak grassy smell	1	0
	10:14 AM	S	0-1	1	1	NO	N/A		EA	Very weak grassy smell	1	0

Location	Time	Field Conditions		Weather Conditions		Odor Present? (Yes/No)	OS <sup>7</sup>	D/T in the field	A <sup>6</sup>	Odor Character <sup>3</sup>	IS (0-6) <sup>4</sup>	HT (1 to-3) <sup>5</sup>
		Wind Direction	Wind Velocity (mph)	Sunny/Cloudy <sup>1</sup>	Rain <sup>2</sup>							
7- Renaissance Dr	10:23 AM	N/A	0	1	1	NO	N/A		AP	Very weak grassy/floral smell	1	1
	10:23 AM	N/A	0	1	1	NO	N/A		EA	Very weak grassy/floral smell	1	1
8- RWF nearby	10:32 AM	N	1	1	1	Yes	4	39	AP	Sewage	3	-1
	10:32 AM	N	1	1	1	Yes	10	8	EA	Chemical/Sour	3	-1
9- ZWED nearby	10:48 AM	NW	4	1	1	Yes	7	13	AP	Pine? Chemical	3	0
	10:48 AM	NW	4	1	1	Yes	8	11	EA	Chemical	3	0
10- ZWED/RWF Upwind	11:04 AM	SW	3	1	1	NO	N/A		AP	Fresh Wetland	0-1	0
	11:04 AM	SW	3	1	1	NO	N/A		EA	Fresh Wetland	0-1	0
11- RWF Lagoons nearby	11:22 AM	N	1	1	1	NO	N/A		AP	No distinct smell	0	0
	11:22 AM	N	1	1	1	NO	N/A		EA	No distinct smell	0	0
12- Main Lift Station nearby	11:30 AM	E	1	1	1	Yes	6	20	AP	Sewage	3	-1
	11:30 AM	E	1	1	1	Yes	7	13	EA	Sewage	2	-1
13- NIRRP nearby	11:43 AM	SE	1	1	1	Yes	7	13	AP	Chemical/paint + manure	1	0
	11:43 AM	SE	1	1	1	Yes	7	13	EA	Paint	1	0
14- NIRRP upwind	5:00 PM	SE	8	1	1	NO	N/A		AP	No distinct smell	0	0

Location	Time	Field Conditions		Weather Conditions		Odor Present? (Yes/No)	OS <sup>7</sup>	D/T in the field	A <sup>6</sup>	Odor Character <sup>3</sup>	IS (0-6) <sup>4</sup>	HT (1 to-3) <sup>5</sup>
		Wind Direction	Wind Velocity (mph)	Sunny/ Cloudy <sup>1</sup>	Rain <sup>2</sup>							
	5:00 PM	SE	8	1	1	NO	N/A		EA	No distinct smell	0	0
Bio-reactors	2:50 PM	NW	5	1	1	Yes	8	11	AP	Sewage	5	-2
	2:50 PM	NW	5	1	1	Yes	9	9	EA	Sewage/ Sour	4	-1
East Primaries	3:10 PM	SW	5	1	1	Yes	8	11	AP	Sewage	5	-2
	3:10 PM	SW	5	1	1	Yes	6	20	EA	Sewage	4	-1
Drying Beds	3:53 PM	E	13	1	1	Yes	5	28	AP	Manure	4	-1
	3:53 PM	E	13	1	1	Yes	4	39	EA	Fertilizer	4	-1
Lagoons nearby	4:15 AM	SW	14	1	1	Yes	11	6	AP	Ocean water with Seagulls	3	-1
	4:15 AM	SW	14	1	1	Yes	11	6	EA	Ocean water with Seagulls	3	-1

1. Weather Conditions: Sunny (1), partly cloudy (2), mostly cloudy (3), overcast (4), hazy (5)

2. Precipitation: None (1), fog (2), light rain (3), rain (4)

3. Odor Character: e.g. earthy, musty, rotten egg, urine, sour, ammonia, sweet, chemical, fishy, seaweed, agricultural, superphosphate, and other (please state)

4. Odor Intensity: Not Detectable (0), Very Weak (1), Weak (2), Distinct (3), Strong (4), Very Strong (5), Extremely Strong (6)

5. Hedonic Tone: Pleasant (1), Neutral (0), unpleasant (-1), revolting (-2), nauseating (-3)

6. Assessor: Initials of person conducting assessment.

7. Odor Strength (field olfactometer). Measured reading from Scentroid SM100.

\*Note: N/A = non-detect on the Scentroid SM100 with the U-2 plate

**Table B-4. Field Odor Measurements at and around Newby, October 21, 2020.**

Location	Time	Weather Conditions				Odor Present? (Yes/No)	OS <sup>7</sup>	D/T in the field	A <sup>6</sup>	Odor Character <sup>3</sup>	IS (0-6) <sup>4</sup>	HT (1 to-3) <sup>5</sup>
		Wind Direction	Wind Velocity (mph)	Sunny/ Cloudy <sup>1</sup>	Rain <sup>2</sup>							
1- Warm Springs Blvd	3:19 PM	SE-SW	0-2	1	1	NO	N/A		AP	No distinct smell	0	0
	3:19 PM	SE-SW	0-2	1	1	NO	N/A		EA	No distinct smell	0	0
2- Scott Creek Road	3:03 PM	SW	0-3	1	1	Yes	7	13	AP	Garbage	2	-1
	3:03 PM	SW	0-3	1	1	Yes	12	6	EA		1	0
3- Milmont Dr	2:52 PM	W-NW	4	1	1	NO	N/A		AP	No distinct smell	0	0
	2:52 PM	W-NW	4	1	1	NO	N/A		EA	No distinct smell	0	0
4- Tramway Dr	2:37 PM	SW	4	1	1	NO	N/A		AP	No distinct smell	0	0
	2:37 PM	SW	4	1	1	NO	N/A		EA	No distinct smell	0	0
5- Marilyn Dr	2:26 PM	W-SW	4	1	1	Yes	N/A		AP	No distinct smell	0	0
	2:26 PM	W-SW	4	1	1	Yes	N/A		EA	No distinct smell	0	0
6- Zanker Rd	2:15 PM	SW-NW	3-7	1	1	NO	N/A		AP	Very weak grassy smell	0	0
	2:15 PM	SW-NW	3-7	1	1	NO	N/A		EA	Very weak grassy smell	0	0
7- Renaissance Dr	2:08 PM	W-NW	3-4	1	1	NO	N/A		AP	No distinct smell	0	0
	2:08 PM	W-NW	3-4	1	1	NO	N/A		EA	No distinct smell	0	0

Location	Time	Weather Conditions				Odor Present? (Yes/No)	OS <sup>7</sup>	D/T in the field	A <sup>6</sup>	Odor Character <sup>3</sup>	IS (0-6) <sup>4</sup>	HT (1 to-3) <sup>5</sup>
		Wind Direction	Wind Velocity (mph)	Sunny/Cloudy <sup>1</sup>	Rain <sup>2</sup>							
8- RWF nearby	1:55 PM	W-NW	3	1	1	Yes	7	13	AP	Garbage	2	-1
	1:55 PM	W-NW	3	1	1	Yes	15	4	EA	Chemical/Sour	1	-1
9- ZWED nearby	1:37 PM	SW-NW	3	1	1	Yes	8	11	AP	Garbage	3	-1
	1:37 PM	SW-NW	3	1	1	Yes	6	20	EA	Garbage/Grass	3	-1
10- ZWED/RWF Upwind	1:22 PM	W-SW	3	1	1	NO	15	4	AP	Gulf water, Marshland	1	0
	1:22 PM	W-SW	3	1	1	NO	N/A		EA	Ocean Water	1	0
11- RWF Lagoons nearby	11:37 AM	NW	1	1	1	NO	N/A		AP	No distinct smell	0	0
	11:37 AM	NW	1	1	1	NO	N/A		EA	No distinct smell	0	0
12- Main Lift Station	11:25 AM	SW	1	1	1	Yes	8	11	AP	Fertilizer	3	-1
	11:25 AM	SW	1	1	1	Yes	7	13	EA	Chemical/Fertilizer	3	-1
13- NIRRP nearby	11:16 AM	W-SW	3-4	1	1	Yes	15	4	AP	Fertilizer	1	-1
	11:16 AM	W-SW	3-4	1	1	Yes	12	6	EA	Fertilizer	1	0
Compost Piles	8:45 AM	E-NE	2	1	1	Yes	3	57	AP	Manure/Garbage	5	-2
	8:45 AM	E-NE	2	1	1	Yes	3	57	EA	Garbage	5	-2
Working Face	9:45 AM	SE	1	1	1	Yes	3	57	AP	Fertilizer/Garbage	6	-3
	9:45 AM	SE	1	1	1	Yes	3	57	EA	Garbage/Sour	6	-3
Landfill Gas	10:00 AM	SE	1-2	1	1	Yes	8	11	AP	Fertilizer/Garbage	3	-1
	10:00 AM	SE	1-2	1	1	Yes	7	13	EA	Garbage/Sour	3	-1
Bio-Stockpiling	10:22 AM	NW	2	1	1	Yes	2	119	AP	Fertilizer/Garbage	4	-2

Location	Time	Weather Conditions				Odor Present? (Yes/No)	OS <sup>7</sup>	D/T in the field	A <sup>6</sup>	Odor Character <sup>3</sup>	IS (0-6) <sup>4</sup>	HT (1 to-3) <sup>5</sup>
		Wind Direction	Wind Velocity (mph)	Sunny/Cloudy <sup>1</sup>	Rain <sup>2</sup>							
	10:22 AM	NW	2	1	1	Yes	3	57	EA	Garbage/Sour	4	-1
NISL Upwind	10:37 AM	W-NW	3	1	1	Yes	8	11	AP	Fertilizer	3	-1
	10:37 AM	W-NW	3	1	1	Yes	7	13	EA	Landfill leachate	3	-1
MRF	10:50 AM	W-SW	3	1	1	Yes	12	6	AP	Fertilizer	4	-1
	10:50 AM	W-SW	3	1	1	Yes	13	5	EA	Garbage	3	-1

1. Weather Conditions: Sunny (1), partly cloudy (2), mostly cloudy (3), overcast (4), hazy (5)
  2. Precipitation: None (1), fog (2), light rain (3), rain (4)
  3. Odor Character: e.g. earthy, musty, rotten egg, urine, sour, ammonia, sweet, chemical, fishy, seaweed, agricultural, superphosphate, and other (please state)
  4. Odor Intensity: Not Detectable (0), Very Weak (1), Weak (2), Distinct (3), Strong (4), Very Strong (5), Extremely Strong (6)
  5. Hedonic Tone: Pleasant (1), Neutral (0), unpleasant (-1), revolting (-2), nauseating (-3)
  6. Assessor: Initials of person conducting assessment.
  7. Odor Strength (field olfactometer). Measured reading from Scentroid.SM100
- \*Note: N/A = non-detect on the Scentroid SM100 with the U-2 plate

**Table B-5. Field Odor Measurements at and around RWF, October 22, 2020**

Location	Time	Weather Conditions				Odor Present? (Yes/No)	OS <sup>7</sup>	D/T in the field	A <sup>6</sup>	Odor Character <sup>3</sup>	IS (0-6) <sup>4</sup>	HT (1 to-3) <sup>5</sup>
		Wind Direction	Wind Velocity (mph)	Sunny/Cloudy <sup>1</sup>	Rain <sup>2</sup>							
RWF nearby	12:00 PM	W-NW	1-2	1	1	Y	10-11	10	AP	Sewage	3	-1
	12:10 PM	W-NW	1-2	1	1	Y	11	6	GT	Earthy, musty, sour, sewage, burnt	2	-1
	12:20 PM						11	6	GT	Earthy, musty, sour, sewage, burnt		
ZWED nearby	12:44 PM	NW	4	1	1	Y	1	411	GT	Sweet, garbage, chemical	5	-2
	12:50 PM		4-5	1	1	Y	4	539	GT			
	12:53 PM					Y	4	539	AP	Mildew, garbage	5	-2
Main Lift Station nearby	1:15 AM	N/NE	2-4	1	1	Y	9-10	8	GT	Salty, marsh, sewage	3	-1
				1	1	Y	7-8	12	AP	Salty, sulfur, tangy	4	-1
NIRRP nearby	1:51 AM	W	7	1	1	Y	3	57	GT	Garbage, sweet	4	-1
			9	1	1	Y	4	39	AP	Sweet, garbage	3	-1

1. Weather Conditions: Sunny (1), partly cloudy (2), mostly cloudy (3), overcast (4), hazy (5)
  2. Precipitation: None (1), fog (2), light rain (3), rain (4)
  3. Odor Character: e.g. earthy, musty, rotten egg, urine, sour, ammonia, sweet, chemical, fishy, seaweed, agricultural, superphosphate, and other (please state)
  4. Odor Intensity: Not Detectable (0), Very Weak (1), Weak (2), Distinct (3), Strong (4), Very Strong (5), Extremely Strong (6)
  5. Hedonic Tone: Pleasant (1), Neutral (0), unpleasant (-1), revolting (-2), nauseating (-3)
  6. Assessor: Initials of person conducting assessment.
  7. Odor Strength (field olfactometer). Measured reading from Scentroid.
- \*Note: N/A = non-detect on the Scentroid with the U-2 plate



The wind direction during the sampling event week as measured by the closest official weather station (San José Airport), located about 6 miles from the study area, is shown below.

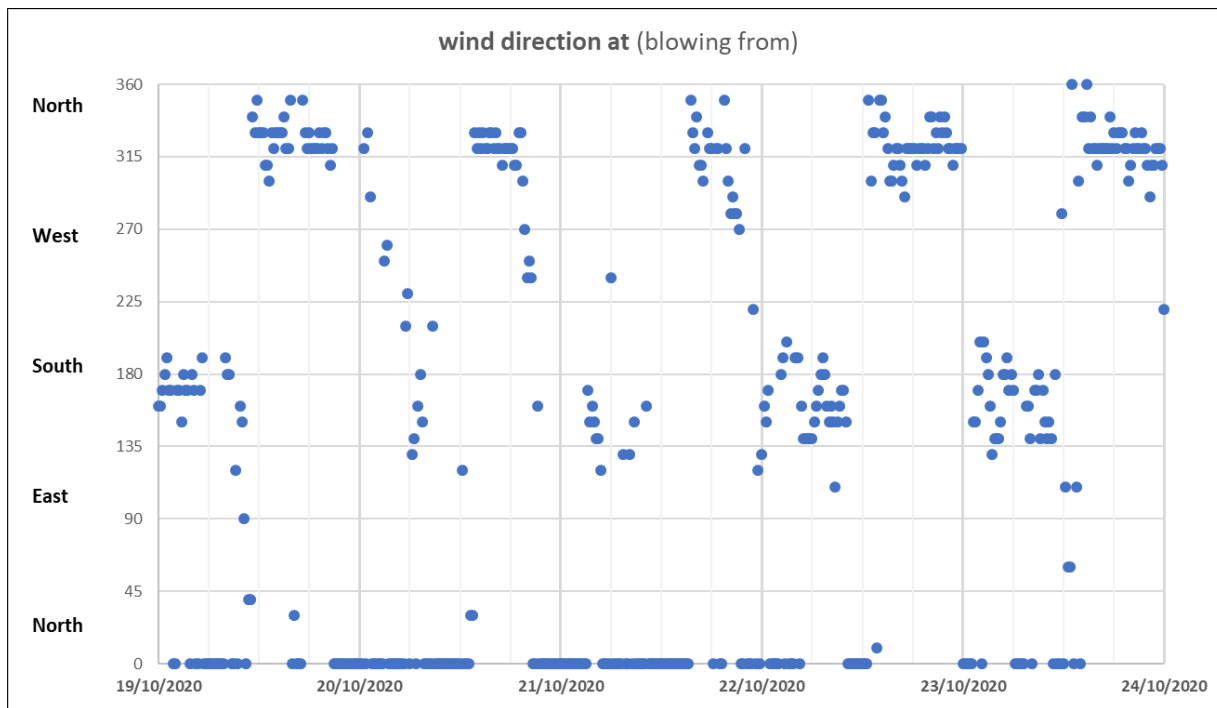

Table B-6. PTR-MS Analysis of ZWED Interior Space Sample

M 102 Bag Sample ZWED Interior Space			
Very unpleasant in space. Smell was very concentrated in room. Very rancid.			
Compound	Concentration (ppbv)	Compound	Concentration (ppbv)
m33.033490 (Methyl alcohol) (Conc)	1062.922	m74.068150 (2-Butanone) (Conc)	176.462
m39.022930 (Cyclopropenylidene) (Conc)	408.374	m74.068150 (Butanal) (Conc)	176.462
m43.017840 (Ketene) (Conc)	671.840	m74.068150 (Ethene, ethoxy-) (Conc)	176.462
m45.033490 (Acetaldehyde) (Conc)	913.660	m74.068150 (Furan, tetrahydro-) (Conc)	176.462
m45.033490 (Ethylene oxide) (Conc)	913.660	m74.068150 (Propanal, 2-methyl-) (Conc)	176.462
m50.999600 (Methyl chloride) (Conc)	10.882	m81.069880 (1,3-Cyclohexadiene) (Conc)	183.993
m57.044720 (NCC <sub>2</sub> H <sub>2</sub> NH <sub>2</sub> ) (Conc)	194.560	m81.069880 (1,4-Cyclohexadiene) (Conc)	183.993
m59.049140 (Acetone) (Conc)	603.004	m81.069880 (1-Methyl-3-methylenecyclobutene) (Conc)	183.993
m59.049140 (Ethene, methoxy-) (Conc)		m82.073230 (1,3-Cyclohexadiene) (Conc)	210.976
m59.049140 (Oxetane) (Conc)		m82.073230 (1,4-Cyclohexadiene) (Conc)	210.976

M 102 Bag Sample ZWED Interior Space			
Very unpleasant in space. Smell was very concentrated in room. Very rancid.			
Compound	Concentration (ppbv)	Compound	Concentration (ppbv)
m59.049140 (Propanal) (Conc)		m82.073230 (1-Methyl-3-methylenecyclobutene) (Conc)	210.976
m59.049140 (Propylene oxide) (Conc)		m85.101180 (2-Butene, 2,3-dimethyl-) (Conc)	10.375
m61.020160 (Phosphirane) (Conc)	377.671	m85.101180 (2-Pentene, 2-methyl-) (Conc)	10.375
m61.028410 (Acetic acid) (Conc)	378.429	m85.101180 (CH3CH=C(CH3)C2H5) (Conc)	10.375
m61.028410 (Methyl formate) (Conc)	378.429	m85.101180 (Cyclohexane) (Conc)	10.375
m62.023520 (Phosphirane) (Conc)	523.373	m86.104530 (2-Butene, 2,3-dimethyl-) (Conc)	14.569
m62.031760 (Acetic acid) (Conc)	523.776	m86.104530 (2-Pentene, 2-methyl-) (Conc)	14.569
m62.031760 (Methyl formate) (Conc)	523.776	m86.104530 (CH3CH=C(CH3)C2H5) (Conc)	14.569
m71.085530 (2-Butene, 2-methyl-) (Conc)	38.415	m86.104530 (Cyclohexane) (Conc)	14.569
m73.046800 (2-Silaisobutene) (Conc)	126.089	m89.023320 (Ethylene carbonate) (Conc)	72.588
m73.064790 (1-Propene, 2-methoxy-) (Conc)	116.522	m89.041950 (CH2=C(CH3)-SCH3) (Conc)	76.023
m73.064790 (2-Butanone) (Conc)	116.522	m89.041950 (Thiophene, tetrahydro-) (Conc)	76.023
m73.064790 (Butanal) (Conc)	116.522	m89.059710 (1,3-Dioxane) (Conc)	71.714
m73.064790 (Ethene, ethoxy-) (Conc)	116.522	m89.059710 (1,4-Dioxane) (Conc)	71.714
m73.064790 (Furan, tetrahydro-) (Conc)	116.522	m89.059710 (Ethene, 1,1-dimethoxy-) (Conc)	71.714
m73.064790 (Propanal, 2-methyl-) (Conc)	116.522	m89.059710 (Ethyl acetate) (Conc)	71.714
m74.068150 (1-Propene, 2-methoxy-) (Conc)	176.462	m89.059710 (Formic acid, 1-methylethyl ester) (Conc)	71.714
m89.059710 (Formic acid, propyl ester) (Conc)	71.714	m101.059710 (2-methyl-2-butenic acid(Z)) (Conc)	6.046
m89.059710 (Propanoic acid, methyl ester) (Conc)	71.714	m101.059710 (Acetylacetone) (Conc)	6.046
m89.070940 (Urea, N,N-dimethyl-) (Conc)	70.634	m101.059710 (Cyclobutane carboxylic acid) (Conc)	6.046
m90.026680 (Ethylene carbonate) (Conc)	111.190	m101.059710 (Cyclopropanecarboxylic acid, methyl ester) (Conc)	6.046
m90.063060 (1,3-Dioxane) (Conc)	81.622	m101.059710 (trans-Alpha,beta-penteneic acid) (Conc)	6.046
m90.063060 (1,4-Dioxane) (Conc)	81.622	m101.078100 (Silane, ethenyltrimethyl-) (Conc)	6.434
m90.063060 (Ethene, 1,1-dimethoxy-) (Conc)	81.622	m102.063060 (2-Butenoic acid, 3-methyl-) (Conc)	8.794
m90.063060 (Ethyl acetate) (Conc)	81.622	m102.063060 (2-Butenoic acid, methyl ester, (E)-) (Conc)	8.794

M 102 Bag Sample ZWED Interior Space			
Very unpleasant in space. Smell was very concentrated in room. Very rancid.			
Compound	Concentration (ppbv)	Compound	Concentration (ppbv)
m90.063060 (Formic acid, 1-methylethyl ester) (Conc)	81.622	m102.063060 (2-Propenoic acid, 2-methyl-, methyl ester) (Conc)	8.794
m90.063060 (Formic acid, propyl ester) (Conc)	81.622	m102.063060 (2-methyl-2-butenic acid(Z)) (Conc)	8.794
m90.063060 (Propanoic acid, methyl ester) (Conc)	81.622	m102.063060 (Acetylacetone) (Conc)	8.794
m90.074290 (Urea, N,N-dimethyl-) (Conc)	107.149	m102.063060 (Cyclobutane carboxylic acid) (Conc)	8.794
m91.037740 (CH <sub>2</sub> =C(CH <sub>3</sub> )-SCH <sub>3</sub> ) (Conc)	119.135	m102.063060 (Cyclopropanecarboxylic acid, methyl ester) (Conc)	8.794
m91.037740 (Thiophene, tetrahydro-) (Conc)	119.135	m102.063060 (trans-Alpha,beta-pentenoic acid) (Conc)	8.794
m93.069880 (2,5-Norbornadiene) (Conc)	26.192	m102.081460 (Silane, ethenyltrimethyl-) (Conc)	9.346
m93.069880 (Toluene) (Conc)	26.192	m103.057600 (2H-Thiopyran, tetrahydro-) (Conc)	8.827
m94.073230 (2,5-Norbornadiene) (Conc)	36.556	m103.075360 (Acetic acid, 1-methylethyl ester) (Conc)	8.336
m94.073230 (Toluene) (Conc)	36.556	m103.075360 (Butanoic acid, methyl ester) (Conc)	8.336
m95.049140 (1-Propyne, 3,3-oxybis-) (Conc)	31.699	m103.075360 (Formic acid, butyl ester) (Conc)	8.336
m95.049140 (Phenol) (Conc)	31.699	m103.075360 (Propanoic acid, 2-methyl-, methyl ester) (Conc)	8.336
m95.085530 (2-Norbornene) (Conc)	30.710	m103.075360 (cis-1,2-Cyclopentanediol) (Conc)	8.336
m96.052500 (1-Propyne, 3,3-oxybis-) (Conc)	43.863	m103.075360 (n-Propyl acetate) (Conc)	8.336
m96.052500 (Phenol) (Conc)	43.863	m103.086590 ((CH <sub>3</sub> ) <sub>2</sub> N-CH=N-OCH <sub>3</sub> ) (Conc)	8.225
m96.088880 (2-Norbornene) (Conc)	36.335	m103.111740 (Di-n-propyl ether) (Conc)	8.122
m101.059710 (2-Butenoic acid, 3-methyl-) (Conc)	6.046	m103.111740 (Diisopropyl ether) (Conc)	8.122
m101.059710 (2-Butenoic acid, methyl ester, (E)-) (Conc)	6.046	m103.111740 (Propane, 1-methoxy-2,2-dimethyl-) (Conc)	8.122
m101.059710 (2-Propenoic acid, 2-methyl-, methyl ester) (Conc)	6.046	m103.111740 (Propane, 2-ethoxy-2-methyl-) (Conc)	8.122
m104.060950 (2H-Thiopyran, tetrahydro-) (Conc)	11.643	m116.126330 ((CH <sub>3</sub> ) <sub>2</sub> N-CH=N-(1-methylethyl)) (Conc)	5.118
m104.075380 (Boric acid, trimethyl ester) (Conc)	2.896	m116.126330 ((CH <sub>3</sub> ) <sub>2</sub> N-CH=N-(n-propyl)) (Conc)	5.118

M 102 Bag Sample ZWED Interior Space			
Very unpleasant in space. Smell was very concentrated in room. Very rancid.			
Compound	Concentration (ppbv)	Compound	Concentration (ppbv)
m104.078710 (Acetic acid, 1-methylethyl ester) (Conc)	10.766	m116.126330 (Pyridazine hexahydro-1,2-dimethyl-) (Conc)	5.118
m104.078710 (Butanoic acid, methyl ester) (Conc)	10.766	m117.069880 (3-Methylphenylacetylene) (Conc)	3.454
m104.078710 (Formic acid, butyl ester) (Conc)	10.766	m117.069880 (Benzene, 1-ethynyl-4-methyl-) (Conc)	3.454
m104.078710 (Propanoic acid, 2-methyl-, methyl ester) (Conc)	10.766	m117.069880 (Indene) (Conc)	3.454
m104.078710 (cis-1,2-Cyclopentanediol) (Conc)	10.766	m117.082760 ((CH <sub>2</sub> ) <sub>5</sub> PCH <sub>3</sub> ) (Conc)	3.320
m104.078710 (n-Propyl acetate) (Conc)	10.766	m117.091010 (4-Hydroxy-4-methylpentan-2-one) (Conc)	3.316
m104.089940 ((CH <sub>3</sub> ) <sub>2</sub> N-CH=N-OCH <sub>3</sub> ) (Conc)	13.199	m117.091010 (Propanoic acid, 2,2-dimethyl-, methyl ester) (Conc)	3.316
m104.115100 (Di-n-propyl ether) (Conc)	8.604	m117.091010 (cis-1,3-cyclohexandiol) (Conc)	3.316
m104.115100 (Diisopropyl ether) (Conc)	8.604	m117.091010 (trans-1,3-cyclohexanol) (Conc)	3.316
m104.115100 (Propane, 1-methoxy-2,2-dimethyl-) (Conc)	8.604	m117.102240 (Urea, tetramethyl-) (Conc)	3.266
m104.115100 (Propane, 2-ethoxy-2-methyl-) (Conc)	8.604	m117.127390 (Propane, 2-methyl-2-(1-methylethoxy)-) (Conc)	3.197
m105.071750 (Boric acid, trimethyl ester) (Conc)	3.165	m118.073230 (3-Methylphenylacetylene) (Conc)	3.051
m115.111740 (1-Methoxycyclohexane) (Conc)	3.179	m118.073230 (Benzene, 1-ethynyl-4-methyl-) (Conc)	3.051
m115.111740 (3-Pentanone, 2,4-dimethyl-) (Conc)	3.179	m118.073230 (Indene) (Conc)	3.051
m115.111740 (4-Heptanone) (Conc)	3.179	m118.086120 ((CH <sub>2</sub> ) <sub>5</sub> PCH <sub>3</sub> ) (Conc)	4.382
m115.111740 (Cyclohexanemethanol) (Conc)	3.179	m118.094360 (4-Hydroxy-4-methylpentan-2-one) (Conc)	4.370
m115.122970 ((CH <sub>3</sub> ) <sub>2</sub> N-C(CH <sub>3</sub> )=NC <sub>2</sub> H <sub>5</sub> ) (Conc)	3.081	m118.094360 (Propanoic acid, 2,2-dimethyl-, methyl ester) (Conc)	4.370
m115.122970 ((CH <sub>3</sub> ) <sub>2</sub> N-CH=N-(1-methylethyl)) (Conc)	3.081	m118.094360 (cis-1,3-cyclohexandiol) (Conc)	4.370
m115.122970 ((CH <sub>3</sub> ) <sub>2</sub> N-CH=N-(n-propyl)) (Conc)	3.081	m118.094360 (trans-1,3-cyclohexanol) (Conc)	4.370
m115.122970 (Pyridazine hexahydro-1,2-dimethyl-) (Conc)	3.081	m118.105590 (Urea, tetramethyl-) (Conc)	5.148
m116.115100 (1-Methoxycyclohexane) (Conc)	4.557	m118.130750 (Propane, 2-methyl-2-(1-methylethoxy)-) (Conc)	3.571

M 102 Bag Sample ZWED Interior Space			
Very unpleasant in space. Smell was very concentrated in room. Very rancid.			
Compound	Concentration (ppbv)	Compound	Concentration (ppbv)
m116.115100 (3-Pentanone, 2,4-dimethyl-) (Conc)	4.557	m121.101180 (Benzene, (1-methylethyl)-) (Conc)	4.162
m116.115100 (4-Heptanone) (Conc)	4.557	m121.101180 (Benzene, 1,3,5-trimethyl-) (Conc)	4.162
m116.115100 (Cyclohexanemethanol) (Conc)	4.557	m121.101180 (Benzene, propyl-) (Conc)	4.162
m116.126330 ((CH3)2N-C(CH3)=NC2H5) (Conc)	5.118	m122.104530 (Benzene, (1-methylethyl)-) (Conc)	4.790
m122.104530 (Benzene, 1,3,5-trimethyl-) (Conc)	4.790	m140.126330 (3(5)-methyl-5(3)-t-butylpyrazole) (Conc)	4.259
m122.104530 (Benzene, propyl-) (Conc)	4.790	m140.126330 (3,5-diethyl-4-methylpyrazole) (Conc)	4.259
m137.107320 (1,4-Benzenediamine, N,N-dimethyl-) (Conc)	94.049	m153.127390 (Camphor) (Conc)	4.095
m137.107320 (1-Azabicyclo[2.2.2]octane-4-carbonitrile) (Conc)	94.049	m153.138620 (1,8-diazabicyclo[5.4.0]undec-7-ene) (Conc)	4.011
m137.107320 (1-azabicyclo[2.2.2]-octane, 2-cyano) (Conc)	94.049	m154.130750 (Camphor) (Conc)	4.691
m137.107320 (1-azabicyclo[2.2.2]-octane, 3-cyano) (Conc)	94.049	m154.141980 (1,8-diazabicyclo[5.4.0]undec-7-ene) (Conc)	5.102
m137.132480 (1,5,5-Trimethyl-3-methylenecyclohexene) (Conc)	93.736	m167.085530 (Fluorene) (Conc)	2.139
m137.132480 (Limonene) (Conc)	93.736	m168.088880 (Fluorene) (Conc)	2.335
m138.110680 (1,4-Benzenediamine, N,N-dimethyl-) (Conc)	130.499	m195.076420 (3-NO2-C6H4CON(CH3)2) (Conc)	1.962
m138.110680 (1-Azabicyclo[2.2.2]octane-4-carbonitrile) (Conc)	130.499	m195.076420 (Benzamide, N,N-dimethyl-4-nitro-) (Conc)	1.962
m138.110680 (1-azabicyclo[2.2.2]-octane, 2-cyano) (Conc)	130.499	m195.093500 (-t-butylstyrene,3-Cl) (Conc)	2.595
m138.110680 (1-azabicyclo[2.2.2]-octane, 3-cyano) (Conc)	130.499	m195.099980 (4-F-C6H4-C(Si(CH3)3)=CH2) (Conc)	2.091
m138.135830 (1,5,5-Trimethyl-3-methylenecyclohexene) (Conc)	104.044	m195.112800 (N,N,2,6-Tetramethyl-4-nitroaniline) (Conc)	1.888
m138.135830 (Limonene) (Conc)	104.044	m195.137960 (Tricyclo[3.3.1.1.3,7]decane-1-carboxylic acid, methyl ester) (Conc)	1.795
m139.111740 (2-Cyclohexen-1-one, 3,5,5-trimethyl-) (Conc)	3.361	m196.079770 (3-NO2-C6H4CON(CH3)2) (Conc)	3.460

M 102 Bag Sample ZWED Interior Space			
Very unpleasant in space. Smell was very concentrated in room. Very rancid.			
Compound	Concentration (ppbv)	Compound	Concentration (ppbv)
m139.122970 (1,5-diazabicyclo[4.4.0]dec-6-ene (DBD)) (Conc)	3.301	m196.079770 (Benzamide, N,N-dimethyl-4-nitro-) (Conc)	3.460
m139.122970 (1-methyl-3-t-butylpyrazole) (Conc)	3.301	m196.103340 (4-F-C6H4-C(Si(CH3)3)=CH2) (Conc)	2.879
m139.122970 (1-methyl-5-t-butylpyrazole) (Conc)	3.301	m196.116160 (N,N,2,6-Tetramethyl-4-nitroaniline) (Conc)	2.744
m139.122970 (3(5)-methyl-5(3)-t-butylpyrazole) (Conc)	3.301	m196.141310 (Tricyclo[3.3.1.13,7]decane-1-carboxylic acid, methyl ester) (Conc)	1.940
m139.122970 (3,5-diethyl-4-methylpyrazole) (Conc)	3.301	m197.090550 (-t-butylstyrene,3-Cl) (Conc)	0.502
m140.115100 (2-Cyclohexen-1-one, 3,5,5-trimethyl-) (Conc)	3.866	m203.943050 (Permascal Frag.) (Conc)	9.084
m140.126330 (1,5-diazabicyclo[4.4.0]dec-6-ene (DBD)) (Conc)	4.259	m204.946400 (Permascal Frag.) (Conc)	10.574
m140.126330 (1-methyl-3-t-butylpyrazole) (Conc)	4.259	m330.847520 (Permascal) (Conc)	4.085
m140.126330 (1-methyl-5-t-butylpyrazole) (Conc)	4.259	m331.850880 (Permascal) (Conc)	4.588

Table B-7. PTR-MS Analysis of RWF Primary Clarifier Sample

M 201 Primary Clarifier Effluent Weir Collection Box			
High H2S emission, launders, channel and collection box			
Compound	Concentration (ppbv)	Compound	Concentration (ppbv)
m33.033490 (Methyl alcohol) (Conc)	44.930	m59.049140 (Propylene oxide) (Conc)	50.410
m33.993530 (O2) (Conc)	0.000	m60.052500 (Acetone) (Conc)	61.854
m34.036850 (Methyl alcohol) (Conc)	673.248	m60.052500 (Acetone) (Conc)	61.854
m39.022930 (C3H2) (Conc)	11.965	m60.052500 (Ethene, methoxy-) (Conc)	61.854
m39.022930 (Cyclopropenylidene) (Conc)	11.965	m60.052500 (Oxetane) (Conc)	61.854
m39.032650 (Water Cluster) (Conc)	0.000	m60.052500 (Propanal) (Conc)	61.854
m40.026280 (C3H2) (Conc)	16.544	m60.052500 (Propylene oxide) (Conc)	61.854

M 201 Primary Clarifier Effluent Weir Collection Box			
High H2S emission, launders, channel and collection box			
Compound	Concentration (ppbv)	Compound	Concentration (ppbv)
m40.026280 (Cyclopropenylidene) (Conc)	16.544	m63.026300 (Dimethyl sulfide) (Conc)	3.052
m43.054230 (Cyclopropane) (Conc)	14.907	m63.026300 (Ethanethiol) (Conc)	3.052
m43.054230 (Propene) (Conc)	14.907	m65.022090 (Dimethyl sulfide) (Conc)	4.733
m44.057580 (Cyclopropane) (Conc)	20.305	m65.022090 (Ethanethiol) (Conc)	4.733
m44.057580 (Propene) (Conc)	20.305	m71.085530 (2-Butene, 2-methyl-) (Conc)	1.273
m46.994770 (H2SiO) (Conc)	5.664	m72.088880 (2-Butene, 2-methyl-) (Conc)	1.761
m46.994770 (HSiOH) (Conc)	5.664	m73.046800 (2-Silaisobutene) (Conc)	1.865
m47.994340 (H2SiO) (Conc)	27.714	m74.046370 (2-Silaisobutene) (Conc)	3.481
m47.994340 (HSiOH) (Conc)	27.714	m79.054230 (Benzene) (Conc)	0.438
m49.010650 (Methanethiol) (Conc)	58.916	m80.057580 (Benzene) (Conc)	0.622
m51.006440 (Methanethiol) (Conc)	65.207	m80.933440 (Hydrogen bromide) (Conc)	0.593
m57.069880 (1-Propene, 2-methyl-) (Conc)	3.971	m81.069880 (1,3-Cyclohexadiene) (Conc)	1.198
m57.069880 (2-Butene, (E)-) (Conc)	3.971	m81.069880 (1,4-Cyclohexadiene) (Conc)	1.198
m58.073230 (1-Propene, 2-methyl-) (Conc)	7.614	m81.069880 (1-Methyl-3-methylenecyclobutene) (Conc)	1.198
m58.073230 (2-Butene, (E)-) (Conc)	7.614	m82.073230 (1,3-Cyclohexadiene) (Conc)	1.408
m59.049140 (Acetone) (Conc)	50.410	m82.073230 (1,4-Cyclohexadiene) (Conc)	1.408
m59.049140 (Acetone) (Conc)	50.410	m82.073230 (1-Methyl-3-methylenecyclobutene) (Conc)	1.408
m59.049140 (Ethene, methoxy-) (Conc)	50.410	m82.931390 (Hydrogen bromide) (Conc)	0.324
m59.049140 (Oxetane) (Conc)	50.410	m82.944980 (Dichloromethylene) (Conc)	0.340
m59.049140 (Propanal) (Conc)	50.410	m84.942030 (Dichloromethylene) (Conc)	0.615
m85.064790 (2-Butenal,2-methyl-(Z)-) (Conc)	0.925	m86.104530 (2-Pentene, 2-methyl-) (Conc)	1.082
m85.064790 (2-Butenal,2-methyl-(Z)-) (Conc)	0.925	m86.104530 (CH3CH=C(CH3)C2H5) (Conc)	1.082
m85.064790 (2-pentenal(E)) (Conc)	0.925	m86.104530 (Cyclohexane) (Conc)	1.082
m85.064790 (2H-Pyran, 3,4-dihydro-) (Conc)	0.925	m93.057300 (Anilino radical) (Conc)	1.341
m85.064790 (3-Buten-2-one, 3-methyl-) (Conc)	0.925	m93.069880 (2,5-Norbornadiene) (Conc)	1.339
m85.064790 (3-Penten-2-one) (Conc)	0.925	m93.069880 (Toluene) (Conc)	1.339
m85.064790 (3-methyl-2-butenal) (Conc)	0.925	m94.060660 (Anilino radical) (Conc)	1.966

M 201 Primary Clarifier Effluent Weir Collection Box			
High H2S emission, launders, channel and collection box			
Compound	Concentration (ppbv)	Compound	Concentration (ppbv)
m85.064790 (4-Methyl-2,3-dihydrofuran) (Conc)	0.925	m94.073230 (2,5-Norbornadiene) (Conc)	1.649
m85.064790 (Cyclopentanone) (Conc)	0.925	m94.073230 (Toluene) (Conc)	1.649
m85.064790 (Ethanone, 1-cyclopropyl-) (Conc)	0.925	m113.015250 (Benzene, chloro-) (Conc)	0.147
m85.064790 (Furan, 2,3-dihydro-5-methyl-) (Conc)	0.925	m115.012300 (Benzene, chloro-) (Conc)	0.241
m85.101180 (2-Butene, 2,3-dimethyl-) (Conc)	0.904	m137.107320 (1,4-Benzenediamine, N,N-dimethyl-) (Conc)	0.622
m85.101180 (2-Pentene, 2-methyl-) (Conc)	0.904	m137.107320 (1-Azabicyclo[2.2.2]octane-4-carbonitrile) (Conc)	0.622
m85.101180 (CH3CH=C(CH3)C2H5) (Conc)	0.904	m137.107320 (1-azabicyclo[2.2.2]-octane, 2-cyano) (Conc)	0.622
m85.101180 (Cyclohexane) (Conc)	0.904	m137.107320 (1-azabicyclo[2.2.2]-octane, 3-cyano) (Conc)	0.622
m86.068150 (2-Butenal,2-methyl-(Z)-) (Conc)	1.358	m137.132480 (1,5,5-Trimethyl-3-methylenecyclohexene) (Conc)	0.620
m86.068150 (2-Butenal,2-methyl-(Z)-) (Conc)	1.358	m137.132480 (Limonene) (Conc)	0.620
m86.068150 (2-pentenal(E)) (Conc)	1.358	m138.110680 (1,4-Benzenediamine, N,N-dimethyl-) (Conc)	0.846
m86.068150 (2H-Pyran, 3,4-dihydro-) (Conc)	1.358	m138.110680 (1-Azabicyclo[2.2.2]octane-4-carbonitrile) (Conc)	0.846
m86.068150 (3-Buten-2-one, 3-methyl-) (Conc)	1.358	m138.110680 (1-azabicyclo[2.2.2]-octane, 2-cyano) (Conc)	0.846
m86.068150 (3-Penten-2-one) (Conc)	1.358	m138.110680 (1-azabicyclo[2.2.2]-octane, 3-cyano) (Conc)	0.846
m86.068150 (3-methyl-2-butenal) (Conc)	1.358	m138.135830 (1,5,5-Trimethyl-3-methylenecyclohexene) (Conc)	0.668
m86.068150 (4-Methyl-2,3-dihydrofuran) (Conc)	1.358	m138.135830 (Limonene) (Conc)	0.668
m86.068150 (Cyclopentanone) (Conc)	1.358	m203.943050 (Permascal Frag.) (Conc)	0.989
m86.068150 (Ethanone, 1-cyclopropyl-) (Conc)	1.358	m204.946400 (Permascal Frag.) (Conc)	1.128
m86.068150 (Furan, 2,3-dihydro-5-methyl-) (Conc)	1.358	m330.847520 (Permascal) (Conc)	0.478
m86.104530 (2-Butene, 2,3-dimethyl-) (Conc)	1.082	m331.850880 (Permascal) (Conc)	0.524



Table B-8. PTR-MS Analysis of Newby Composting Pile Sample

M 301 Composting Piles			
Compost piles mixed with odor control bio material. Odors observed were not offensive.			
Compound	Concentration (ppbv)	Compound	Concentration (ppbv)
m33.033490 (Methyl alcohol) (Conc)	384.993	m74.068150 (1-Propene, 2-methoxy-) (Conc)	17.115
m39.022930 (Cyclopropenylidene) (Conc)	86.964	m74.068150 (2-Butanone) (Conc)	17.115
m39.032650 (Water Cluster) (Conc)	0.000	m74.068150 (Butanal) (Conc)	17.115
m43.054230 (Cyclopropane) (Conc)	125.638	m74.068150 (Ethene, ethoxy-) (Conc)	17.115
m43.054230 (Propene) (Conc)	125.638	m74.068150 (Furan, tetrahydro-) (Conc)	17.115
m44.057580 (Propene) (Conc)	162.743	m74.068150 (Propanal, 2-methyl-) (Conc)	17.115
m47.049140 (Dimethyl ether) (Conc)	24.076	m81.069880 (1,3-Cyclohexadiene) (Conc)	7.360
m48.052500 (Dimethyl ether) (Conc)	46.023	m81.069880 (1,4-Cyclohexadiene) (Conc)	7.360
m62.028430 (H3BO3 (B(OH)3)) (Conc)	6.963	m81.069880 (1-Methyl-3-methylenecyclobutene) (Conc)	7.360
m63.024800 (H3BO3 (B(OH)3)) (Conc)	4.298	m82.073230 (1,3-Cyclohexadiene) (Conc)	8.770
m73.046800 (2-Silaisobutene) (Conc)	10.841	m82.073230 (1,4-Cyclohexadiene) (Conc)	8.770
m73.064790 (1-Propene, 2-methoxy-) (Conc)	10.050	m82.073230 (1-Methyl-3-methylenecyclobutene) (Conc)	8.770
m73.064790 (2-Butanone) (Conc)	10.050	m93.057300 (Anilino radical) (Conc)	5.337
m73.064790 (Butanal) (Conc)	10.050	m93.069880 (2,5-Norbornadiene) (Conc)	5.341
m73.064790 (Ethene, ethoxy-) (Conc)	10.050	m93.069880 (Toluene) (Conc)	5.341
m73.064790 (Furan, tetrahydro-) (Conc)	10.050	m94.060660 (Anilino radical) (Conc)	8.056
m73.064790 (Propanal, 2-methyl-) (Conc)	10.050	m94.073230 (2,5-Norbornadiene) (Conc)	6.603
m74.046370 (2-Silaisobutene) (Conc)	15.920	m94.073230 (Toluene) (Conc)	6.603
m107.085530 (Benzene, 1,2-dimethyl-) (Conc)	2.993	m138.110680 (1-Azabicyclo[2.2.2]octane-4-carbonitrile) (Conc)	6.483
m107.085530 (Benzene, 1,3-dimethyl-) (Conc)	2.993	m138.110680 (1-azabicyclo[2.2.2]-octane, 2-cyano) (Conc)	6.483
m107.085530 (Ethylbenzene) (Conc)	2.993	m138.110680 (1-azabicyclo[2.2.2]-octane, 3-cyano) (Conc)	6.483
m107.085530 (p-Xylene) (Conc)	2.993	m138.135830 (1,5,5-Trimethyl-3-methylenecyclohexene) (Conc)	5.154
m108.088880 (Benzene, 1,2-dimethyl-) (Conc)	4.811	m138.135830 (Limonene) (Conc)	5.154
m108.088880 (Benzene, 1,3-dimethyl-) (Conc)	4.811	m153.127390 (Camphor) (Conc)	2.308
m108.088880 (Ethylbenzene) (Conc)	4.811	m153.138620 (1,8-diazabicyclo[5.4.0]undec-7-ene) (Conc)	2.268

M 301 Composting Piles			
Compost piles mixed with odor control bio material. Odors observed were not offensive.			
Compound	Concentration (ppbv)	Compound	Concentration (ppbv)
m108.088880 (p-Xylene) (Conc)	4.811	m154.130750 (Camphor) (Conc)	2.567
m137.107320 (1,4-Benzenediamine, N,N-dimethyl-) (Conc)	4.720	m154.141980 (1,8-diazabicyclo[5.4.0]undec-7-ene) (Conc)	2.802
m137.107320 (1-Azabicyclo[2.2.2]octane-4-carbonitrile) (Conc)	4.720	m203.943050 (Permascal Frag.) (Conc)	9.360
m137.107320 (1-azabicyclo[2.2.2]-octane, 2-cyano) (Conc)	4.720	m204.946400 (Permascal Frag.) (Conc)	11.975
m137.107320 (1-azabicyclo[2.2.2]-octane, 3-cyano) (Conc)	4.720	m205.195080 (1,3-di-(t-C4H9)-5-CH3-C6H3) (Conc)	2.721
m137.132480 (1,5,5-Trimethyl-3-methylenecyclohexene) (Conc)	4.717	m206.198430 (1,3-di-(t-C4H9)-5-CH3-C6H3) (Conc)	2.873
m137.132480 (Limonene) (Conc)	4.717	m330.847520 (Permascal) (Conc)	4.585
m138.110680 (1,4-Benzenediamine, N,N-dimethyl-) (Conc)	6.483	m331.850880 (Permascal) (Conc)	4.930

## B.2 Sampling Event 2 Results

The sample types collected for Sampling Event 2 are summarized below.

Source Facility							
RWF		ZWED		Newby		Offsite	
Location	Sample Type	Location	Sample Type	Location	Sample Type	Location	Sample Type
East Primaries		Interior Space		Landfill Work Face		Upwind	
Bioreactors		Biofilter 1		Compost Piles		Downwind	
Lagoons		Carbon Box		MRF			
Drying Beds		Upwind		Landfill Gas			
		Downwind		Leachate			
				Cake Stockpile			

- = SULFUR ANALYSIS
- = CARBOXYLIC ACID ANALYSIS
- = AMMONIA
- = ODOR ANALYSIS
- = AMINE ANALYSIS
- = OPM
- = ALDEHYDE ANALYSIS (TO-11A)
- = VOC ANALYSIS (TO-17)
- = SPOT H2S

### B.3 Sampling Event 3 Results

A windrose diagram indicating wind speed for the time of sampling during Sampling Event 3 is shown below.

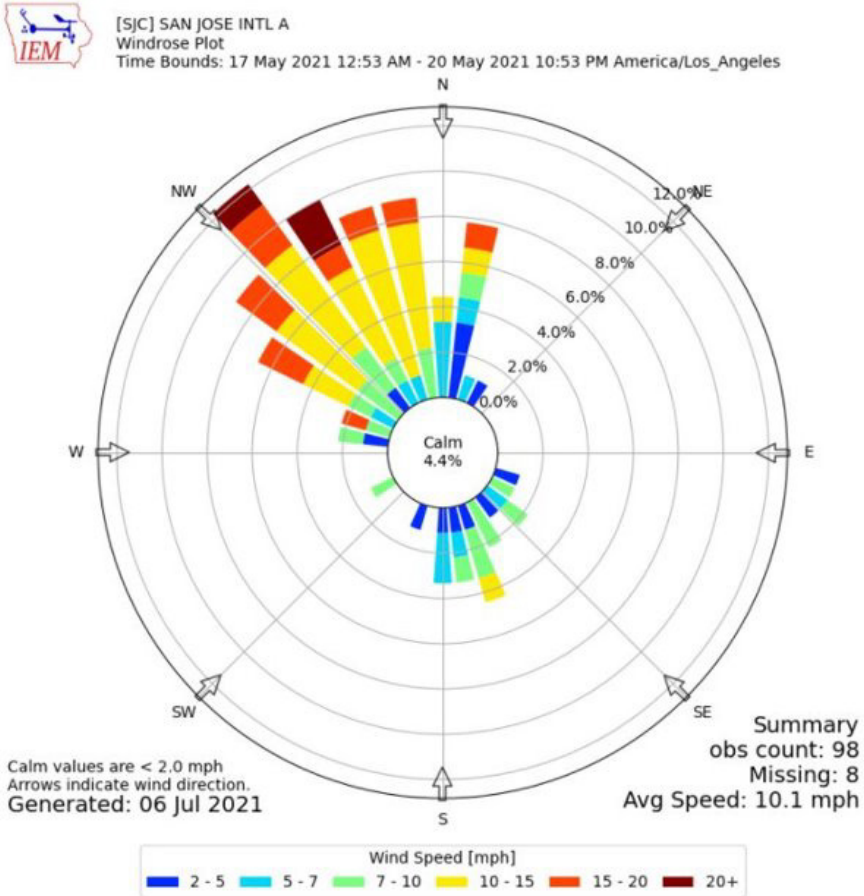

The sample types collected for Sampling Event 3 are summarized below.

Source Facility					
RWF		ZWED		Newby	
Location	Sample Type	Location	Sample Type	Location	Sample Type
East Prim		Interior Space		Landfill WF	
Bioreactors (aerated)		Biofilter 1		Compost Piles (24 hr pile)	
Bioreactors (mixing zone)		Upwind		MRF	
Lagoons		Downwind		Landfill Gas	
Upwind				Upwind	
Downwind				Downwind	

- = SULFUR ANALYSIS
- = CARBOXYLIC ACID ANALYSIS
- = AMMONIA
- = ODOR ANALYSIS
- = VOC ANALYSIS (TO-17)
- = OPM
- = ALDEHYDE ANALYSIS (TO-11A)
- = MONTROSE
- = CONT. H2S

The sulfur rankings for Sampling Event 3 are summarized below.

Source Facility					
RWF		ZWED		Newby	
Location	Odor Ranking	Location	Odor Ranking	Location	Odor Ranking
East Primaries		Interior Space		Landfill Gas	
Bioreactors (aerated)		Biofilter 1			
Bioreactors (mixing zone)					

- = LOW (< 50 PPB)
- = MODERATE (> 50 PPB AND < 1 PPM)
- = HIGH (> 1 PPM)

NOTES:

1. HIGH MM FOR PRIMARIES AND BIOREACTOR MIXING ZONE

\* RANGES ASSIGNED BASED ON ODOR THRESHOLD VALUES FOR ODORANT GROUPING

The aldehyde rankings for Sampling Event 3 are summarized below.

Source Facility					
RWF		ZWED		Newby	
Location	Odor Ranking	Location	Odor Ranking	Location	Odor Ranking
Bioreactor (aerated)	▲	Interior Space	▲	Landfill Work Face	▲
Bioreactors (mixing zone)	▲	Biofilter 1	▲	Compost Piles (24 hr pile)	▲
				Landfill Gas	▲

▲ = LOW (< 10 PPB)

▲ = HIGH (> 100 PPB)

▲ = MODERATE (> 10 PPB AND < 100 PPB)

NOTES:

1. ZWED LOWER THAN OCTOBER
2. NEWBY LANDFILL WF LOWER THAN OCTOBER (NO ZWED WASTE)

\* RANGES ASSIGNED BASED ON ODOR THRESHOLD VALUES FOR ODORANT GROUPING

The carboxylic acid rankings for Sampling Event 3 are summarized below.

Source Facility					
RWF		ZWED		Newby	
Location	Odor Ranking	Location	Odor Ranking	Location	Odor Ranking
Lagoons	▲	Interior Space	▲	Landfill Work Face	▲
Bioreactor (aerated)	▲	Biofilter 1	▲	Compost Piles (24 hr pile)	▲
Bioreactor (mixing zone)	▲			Landfill Gas	▲

▲ = LOW (< 25 PPB)

▲ = HIGH (> 250 PPB)

▲ = MODERATE (> 25 PPB AND < 250 PPB)

NOTES:

1. OVERALL LOWER THAN OCTOBER

\* ALS CARBOXYLIC ANALYSIS NOT COMPLETED DUE TO DISCONTINUATION OF METHOD. VALUES BASED ON TIC (TO-17) AND MONTROSE DATA

The VOC rankings for Sampling Event 3 are summarized below.

Source Facility					
RWF		ZWED		Newby	
Location	Odor Ranking	Location	Odor Ranking	Location	Odor Ranking
Bioreactors (aerated)	▲	Interior Space	▲	Landfill Work Face	▲
Bioreactors (mixing zone)	▲	Biofilter 1	▲	Compost Piles (24 hr pile)	▲
				Landfill Gas	▲

▲ = LOW (< 50 PPB)

▲ = HIGH (> 10 PPM)

▲ = MODERATE (> 50 PPB AND < 10 PPM)

\* RANGES ASSIGNED BASED ON ODOR THRESHOLD VALUES FOR ODORANT GROUPING

Table B-9. Results of Field Odor Measurements on Monday 17 May 2021 (Sampling Event 3).

Location	Time	Field		Weather Conditions		Odor Present? (Yes/No)	Odor Strength (field olfactometer)	Dilution to Threshold in the field	Assessor	Odor Character <sup>3</sup>	Intensity Scale (0 - 6) <sup>4</sup>	Hedonic Tone (1 to -3) <sup>5</sup>
		Wind Direction	Wind Velocity (mph)	Sunny/ Cloudy <sup>1</sup>	Precipitation <sup>2</sup>							
1- Warm Springs Blvd	7:35 AM	S-SE	1-3	4	2	NO	N/A		EA		0	N/A
	7:40 AM	S-SE	1-3	4	2	NO	N/A		GT	Grassy	0	N/A
2- Scott Creek Road	7:50 AM	S-SE	2	4	2	NO	N/A		GT		0	N/A
	8:00 AM	E-SE	2-3	4	2	NO	N/A		EA		0	N/A
3- Wilson Way	8:15 AM	E-NE	1	4	2	NO	N/A		EA	Food/Cooking	0	N/A
	8:15 AM	E-NE	2	4	2	NO	N/A		GT		0	N/A
4- Milmont Dr	8:40 AM	E-SE	2	4	2	NO	N/A		GT		0	N/A
	8:40 AM	E-SE	7	4	2	NO	N/A		EA	Creek	0	N/A
5- Marilyn Dr	9:00 AM	S-SE	2-3	4	2	NO	N/A		GT		0	N/A
	9:00 AM	S-SE	2-3	4	2	NO	N/A		EA		0	N/A
6- Zanker Rd	9:20 AM	S-SW	1	4	2	NO	N/A		GT		0	N/A
	9:20 AM	S-SW	1	4	2	NO	N/A		EA		0	N/A
7- Renaissance Dr	9:30 AM	E	2	3	1	Yes	12	6	GT	Sour	1	0
	9:30 AM	E	2-3	3	1	Yes	14	4	EA	Garbage, Sour	2	-1
8- RWF Downwind	9:50 AM	NE	1-2	2	1	Yes	7	15	GT	Metallic	2	-1
	9:50 AM	NE	1-2	2	1	Yes	12	6	EA	Trash	2	-1
9- ZWED Downwind	10:00 AM	NE	3-5	2	1	Yes	3	88	EA	Chemical, Vinegar	2	-1
	10:00 AM	NE	3-5	2	1	Yes	6	20	GT	Chlorine, Earthy	3	-1
10- ZWED/RWF Upwind	10:20 AM	N-NW	2-3	1	1	NO	N/A		EA	Grassy, Sweet	1	0
	10:20 AM	N-NW	2-3	1	1	NO	N/A		GT	Grassy	0	0
1- RWF Lagoons Downwind	10:40 AM	W-SW	1	1	1	NO	N/A		GT	Floral	1	1
	10:40 AM	W-SW	1	1	1	Yes	13	5	EA	Floral	2	1
12- Main Lift Station	10:50 AM	NE	1	1	1	Yes	4	44	GT	Musty, Marshy	3	-1
	10:50 AM	S-SE	2-4	1	1	Yes	13	5	EA	Asphalt	1	0
13- NIRRP Downwind	11:00 AM	W	1-2	1	1	Yes	13	5	GT	Marshy, Salty	1	0
	11:00 AM	W	1-2	1	1	NO	N/A		EA	Grassy	1	0
14- NIRRP upwind	11:15 AM	W	2-3	1	1	Yes	9	9	GT	Mulch	3	0
	11:15 AM	W	2-3	1	1	Yes	5	29	EA	Mulch, Paint	3	0
ZWED Biofilter #1	1:00 PM	W-NW	3-7	1	1	Yes	9	231	GT	Garbage, Sweet	5	-3
	1:00 PM	W-NW	3-7	1	1	Yes	4	539	EA	Garbage, Sour	6	-3
ZWED Biofilter #1	1:20 PM	N-W	11-12	1	1	Yes	5	430	GT	Garbage, Sweet	5	-3
	1:20 PM	N-W	11-12	1	1	Yes	1	2260	EA	Garbage, Sour	5	-3
ZWED Upwind	1:30 PM	N-NW	7-12	1	1	Yes	15	138	GT	Chlorine, Marshy	1	0
	1:30 PM	N-NW	7-12	1	1	Yes	11	188	EA	Fertilizer	1	0
ZWED Interior Space	2:00 PM	N/A	N/A	N/A	N/A	Yes	<0	>2260	GT	Garbage, Sweet	6	-3
	2:00 PM	N/A	N/A	N/A	N/A	Yes	<0	>2260	EA	Garbage, Sour	6	-3
ZWED Interior Space	2:10 PM	N/A	N/A	N/A	N/A	Yes	<0	>2260	GT	Garbage, Sweet	6	-3
	2:10 PM	N/A	N/A	N/A	N/A	Yes	<0	>2260	EA	Garbage, Sour	6	-3
14- NIRRP upwind	2:40 PM	N-NW	3-5	1	1	NO	N/A		GT		N/A	N/A
	2:40 PM	N-NW	3-5	1	1	NO	N/A		EA		N/A	N/A

2. Precipitation: None (1), fog (2), light rain (3), rain (4)  
 3. Odor Character: eg. earthy, musty, rotten egg, urine, sour, ammonia, sweet, chemical, fishy, seaweed, agricultural, superphosphate, and other (please state)  
 4. Odor Intensity: Not Detectable (0), Very Weak (1), Weak (2), Distinct (3), Strong (4), Very Strong (5), Extremely Strong (6)  
 5. Hedonic Tone: Pleasant (1), Neutral (0), unpleasant (-1), revolting (-2), nauseating (-3)

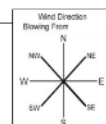

**Table B-10. Results of Field Odor Measurements on Tuesday 18 May 2021 (Sampling Event 3).**

Location	Time	Field		Weather Conditions		Odor Present? (Yes/No)	Odor Strength (field olfactometer)	Dilution to Threshold in the field	Assessor	Odor Character <sup>3</sup>	Intensity Scale (0 - 6) <sup>4</sup>	Hedonic Tone (1 to -3) <sup>5</sup>
		Wind Direction	Wind Velocity (mph)	Sunny/Cloudy <sup>1</sup>	Precipitation <sup>2</sup>							
14- NIRRP upwind	8:30 AM	S-SE	1-2	1	1	No	N/A		EA		N/A	N/A
	8:30 AM	S-SE	1-2	1	1	No	N/A		AP		N/A	N/A
13- NIRRP Downwind	8:35 AM	E-SE	2-3	1	1	No	N/A		EA		N/A	N/A
	8:35 AM	E-SE	2-3	1	1	No	N/A		AP		N/A	N/A
12- Main Lift Station	9:05 AM	E-NE	1-2	1	1	Yes	N/A		EA		0	0
	9:05 AM	E-NE	1-2	1	1	Yes	N/A		AP		0	0
1- RWF Lagoons Downwind	9:17 AM	S-SE	2-4	1	1	No	N/A		EA		N/A	N/A
	9:17 AM	S-SE	2-4	1	1	No	N/A		EA		N/A	N/A
RWF- East Primaries	10:10 AM	N-NW	4-6	1	1	Yes	4	44	EA	Fishy	3	-1
	10:10 AM	N-NW	4-6	1	1	Yes	6	20	AP	Sweet, Garbage	3	-1
RWF- Bioreactors	10:45 AM	N-NW	2-3	1	1	Yes	13	>338	EA	Chemical, Sewage	3	-1
	10:45 AM	N-NW	2-3	1	1	Yes	4	44	AP	Sewage, Chlorine	3	-1
RWF- Lagoons	11:10 AM	N-NW	1-2	1	1	Yes	9	9	EA	Marshy, Chlorine	2	-1
	11:10 AM	N-NW	1-2	1	1	Yes	6	20	AP	Burnt, Salty, Marshy, Decay	3	-1
10- ZWED/RWF Upwind	11:51 AM	N-NE	3-5	1	1	Yes	N/A		EA	Salty, Marshy	1	0
	11:51 AM	N-NE	3-5	1	1	Yes	N/A		AP	Marshy, Wetland	2	0
9- ZWED Downwind	12:00 PM	N-NW	3-5	1	1	Yes	13	5	EA	Grassy	1	0
	12:00 PM	N-NW	3-5	1	1	No	N/A		AP		N/A	N/A
14- NIRRP upwind	12:30 PM	NW-SW	4-8	1	1	No	N/A		EA	Grassy	0	0
	12:30 PM	NW-SW	4-8	1	1	No	N/A		AP		N/A	N/A
8- RWF Downwind	2:40 PM	N-NW	3-8	1	1	Yes	N/A		EA	Chlorine	2	0
	2:40 PM	N-NW	3-8	1	1	Yes	14	4	AP	Chlorine, grassy, chemical	2	-1
7- Renaissance Dr	2:57 PM	NW-NE	3-10	1	1	No	N/A		EA		N/A	N/A
	2:57 PM	NW-NE	3-10	1	1	No	N/A		AP		1	0
6- Zanker Rd	3:03 PM	N-NW	5-14	1	1	Yes	N/A		EA	Grassy, Chlorine	1	0
	3:03 PM	N-NW	5-14	1	1	Yes	N/A		AP	Grassy, chemical, wet, sweet	0	0
5- Marilyn Dr	3:25 PM	N-W	3-12	1	1	No	N/A		EA		N/A	N/A
	3:25 PM	N-W	3-12	1	1	No	N/A		AP		N/A	N/A
3- Wilson Way	3:55 PM	NW-SW	2-11	1	1	No	N/A		EA		N/A	N/A
	3:55 PM	NW-SW	2-11	1	1	No	N/A		AP		N/A	N/A
4- Milmont Dr	4:05 PM	N-NW	3-8	1	1	No	N/A		EA		N/A	N/A
	4:05 PM	N-NW	3-8	1	1	No	N/A		AP		N/A	N/A
2- Scott Creek Road	4:15 PM	NW-W	2-5	1	1	No	N/A		EA		N/A	N/A
	4:15 PM	NW-W	2-5	1	1	No	N/A		AP		N/A	N/A
1- Warm Springs Blvd	4:24 PM	N-NW	3-6	1	1	No	N/A		EA		N/A	N/A
	4:24 PM	N-NW	3-6	1	1	No	N/A		AP		N/A	N/A

**2. Precipitation:** None (1), fog (2), light rain (3), rain (4)  
**3. Odor Character:** eg. earthy, musty, rotten egg, urine, sour, ammonia, sweet, chemical, fishy, seaweed, agricultural, superphosphate, and other (please state)  
**4. Odor Intensity:** Not Detectable (0), Very Weak (1), Weak (2), Distinct (3), Strong (4), Very Strong (5), Extremely Strong (6)  
**5. Hedonic Tone:** Pleasant (1), Neutral (0), unpleasant (-1), revolting (-2), nauseating (-3)



**Table B-11. Results of Field Odor Measurements on Wednesday May 19, 2021 (Sampling Event 3).**

Location	Time	Field		Weather Conditions		Odor Present? (Yes/No)	Odor Strength (field ofactometer)	Dilution to Threshold in the field	Assessor	Odor Character <sup>3</sup>	Intensity Scale (0 - 6) <sup>4</sup>	Hedonic Tone (1 to -3) <sup>5</sup>
		Wind Direction	Wind Velocity (mph)	Sunny/ Cloudy <sup>1</sup>	Precipitation <sup>2</sup>							
14- NIRRP Upwind	7:30 AM	SW	2-3	1	1	No	N/A		GT	Grassy	0	0
	7:30 AM	SW	2-3	1	1	No	N/A		AP		0	0
10- ZWED/RWF Upwind	8:00 AM	N-NW	3-5	1	1	No	N/A		GT		0	0
	8:00 AM	N-NW	3-5	1	1	No	N/A		AP		0	0
9- ZWED Downwind	8:20 AM	NW	3-5	1	1	Yes	11	6	GT	Garbage	0	0
	8:20 AM	NW	3-5	1	1	No	N/A		AP		0	0
9- ZWED Downwind	8:40 AM	SW	3	1	1	Yes	4	44	GT	Earthy, Chemical	4	-1
	8:40 AM	SW	3	1	1	Yes	2	130	AP	Sweet, Garbage, Manure	4	-1
12- Main Lift Station	8:52 AM	W-NW	2-3	1	1	Yes	5	29	GT	Sulfur	3	-1
	8:52 AM	W-NW	2-3	1	1	Yes	12	6	AP	Wastewater	2	-1
1- RWF Lagoons Downwind	9:00 AM	NW	3-7	1	1	No	N/A		GT		N/A	N/A
	9:00 AM	NW	3-7	1	1	No	N/A		AP		N/A	N/A
13- NIRRP Downwind	9:15 AM	W	0-2	1	1	Yes	14	4	GT	Garbage		
	9:15 AM	W	0-2	1	1	Yes	10	8	AP	Manure, Sour	2	-1
Compost Piles	9:55 AM	NW	6-10	1	1	Yes	5	430	GT	Manure, Garbage, Sweet	5	-2
	9:55 AM	NW	6-10	1	1	Yes	3	720	AP	Manure	5	-2
Working Face	10:30 AM	W-NW	2-4	1	1	Yes	4	539	GT	Garbage, Sweet	5	-2
	10:30 AM	W-NW	2-4	1	1	Yes	4	539	AP	Garbage	5	-3
Landfill Gas	10:50 AM	NW	3-6	1	1	Yes	7	299	GT	Garbage, Burnt	4	-1
	10:50 AM	NW	3-6	1	1	Yes	4	539	AP	Garbage, Sweet	5	-3
NIRRP Upwind	11:05 AM	NW	3-4	1	1	No	N/A		GT		N/A	N/A
	11:05 AM	NW	3-4	1	1	No	N/A		AP		N/A	N/A
MRF	11:30 AM	N-NE	2-3	1	1	Yes	4	44	GT	Garbage, Sweet		
	11:30 AM	N-NE	2-3	1	1	Yes	2	130	AP	Garbage		
7- Renaissance Dr	1:18 PM	NE	1-2	1	1	No	N/A		GT		N/A	N/A
	1:18 PM	NE	1-2	1	1				AP			
6- Zanker Rd	1:30 PM	NW	9-13	1	1	No	N/A		AP		N/A	0
	1:30 PM	NW	9-13	1	1	Yes	N/A		GT	Earthy	1	0
8- RWF Downwind	1:50 PM	NW	9-13	1	1	Yes	6	20	GT	Salty, Marshy, Fecal	3	-1
				1	1	Yes	3	88	AP	Chlorine, Sewage	3	-1
5- Marilyn Dr	2:05 PM	N-NW	6-14	1	1	Yes	9	9	GT	Garbage, Sweet	2	0
				1	1	Yes	7	15	AP	Garbage, Sweet	2	-1
4- Milmont Dr	2:20 PM	NW	10-14	1	1	No	N/A		GT		N/A	N/A
				1	1	No	N/A		AP		N/A	N/A
3- Wilson Way	2:30 PM	W-NW	7-10	1	1	No	N/A		GT		N/A	N/A
				1	1	No	N/A		AP		N/A	N/A
2- Scott Creek Road	2:40 PM	W	4-6	1	1	No	N/A		GT		N/A	N/A
				1	1	No	N/A		AP		N/A	N/A
1- Warm Springs Blvd	2:50 PM	NW	5-8	1	1	No	N/A		GT		N/A	N/A
				1	1	No	N/A		AP		N/A	N/A

2. Precipitation: None (1), fog (2), light rain (3), rain (4)  
 3. Odor Character: eg. earthy, musty, rotten egg, urine, sour, ammonia, sweet, chemical, fishy, seaweed, agricultural, superphosphate, and other (please state)  
 4. Odor Intensity: Not Detectable (0), Very Weak (1), Weak (2), Distinct (3), Strong (4), Very Strong (5), Extremely Strong (6)  
 5. Hedonic Tone: Pleasant (1), Neutral (0), unpleasant (-1), revolting (-2), nauseating (-3)

**Table B-12. Results of Field Odor Measurements on Thursday May 20, 2021 (Sampling Event 3).**

Location	Time	Field		Weather Conditions		Odor Present? (Yes/No)	Odor Strength (field olfactometer)	Dilution to Threshold in the field	Assessor	Odor Character <sup>3</sup>	Intensity Scale (0 - 6) <sup>4</sup>	Hedonic Tone (1 to -3) <sup>5</sup>
		Wind Direction	Wind Velocity (mph)	Sunny/ Cloudy <sup>1</sup>	Precipitation <sup>2</sup>							
NIRRP Downwind	8:00 AM	NW	2-3	1	1	Yes	4	44	EA	Garbage	4	-1
	8:00 AM	NW	2-3	1	1	Yes	4	44	AP	Garbage	4	-2
8- RWF Downwind	8:30 AM	SW	4-7	1	1	No	N/A		EA		N/A	N/A
9- ZWED Downwind	8:30 AM	NW	4-7	1	1	Yes	8	11	AP	Salty, Marshy	2	0
	8:36 AM	NW	4	1	1	Yes	5	29	AH	Putrid;Septic;Sewage	4	-2
	8:52 AM	SW	1-2	1	1	Yes	2	>338	EA	Garbage, sour	5	-2
	8:52 AM	SW	1-2	1	1	Yes	2	130	AP	Garbage, sour	5	-3
	8:50 AM	W	1	1	1	Yes	1	2260	AH	usty;Putrid;Rotten;Rotten Vegetables;Stale;	6	-3
10- ZWED/RWF Upwind	9:10 AM	SW	1-2	1	1	No	N/A		EA	Sweet, floral	N/A	N/A
	9:10 AM	SW	1-2	1	1	No	N/A		AP		N/A	N/A
	9:09 AM	W	1	1	1	No	N/A		ML		N/A	N/A
13- NIRRP Downwind	9:30 AM	N-NW	1-4	1	1	Yes	12	6	EA	Garbage	2	-1
	9:30 AM	N-NW	1-4	1	1	Yes	11	6	AP	Garbage	2	-1
	8:15 AM	N-NW	3	1	1	Yes	2	130	AH	Garbage;Metallic	5	-2
12- Main LIR Station	9:40 AM	N-NW	2-3	1	1	Yes	5	29	EA	Chemical, Garbage	2	0
	9:40 AM	W-SW	7-10	1	1	Yes	N/A		AP	Sulfur	2	-1
	9:31 AM	W	4	1	1	Yes	12		AH	Musty;Sewage	2	-1
1- RWF Lagoons Downwind	9:52 AM	W-SW	5-7	1	1	Yes	N/A		EA		0	1
	9:52 AM	W-SW	5-7	1	1	No	N/A		AP	Grassy	N/A	N/A
	9:31 AM	N-NW	3	1	1	Yes	15		AH	Garbage	1	-1
14- NIRRP upwind	9:55 AM	W	5	1	1	No	N/A		ML			
	10:10 AM	NW	7-10	1	1	No	N/A		EA		N/A	N/A
	10:10 AM	NW	7-10	1	1	No	N/A		AP		N/A	N/A
	10:09 AM	W	7	1	1	No	N/A		AH		N/A	N/A
RWF Downwind	11:00 AM	W-NW	4-11	1	1	Yes	3	88	EA	Garbage, Chemical	3	-1
	11:00 AM	W-NW	4-11	1	1	Yes	3	88	AP	Chlorine, VW, Salty	3	-1
	10:44 AM	W	3	1	1	Yes	2	130	AH	Sewage	6	-3
ZWED Downwind	11:27 AM	SW	4-8	1	1	Yes	N/A	>2260	EA	Garbage, Leachate	5	-3
	11:27 AM	SW	4-8	1	1	Yes	N/A	>2260	AP	Garbage, Sour	6	-3
	11:32 AM	W	3	1	1	Yes	1	2260	AH	Putrid;Rancid;Rotten Vegetables;Manure	6	-3
1- Warm Springs Blvd	12:50 PM	SW-NW	2-8	1	1	No	N/A		EA	Grassy	N/A	N/A
	12:50 PM	SW-NW	2-8	1	1	No	N/A		AP		N/A	N/A
2- Scott Creek Road	1:00 PM	NW	7-13	1	1	No	N/A		EA	Floral	0	1
	1:00 PM	NW	7-13	1	1	No	N/A		AP		N/A	N/A
3- Wilson Way	1:05 PM	SW-NW	7-11	1	1	No	N/A		EA		N/A	N/A
	1:05 PM	SW-NW	7-11	1	1	No	N/A		AP		N/A	N/A
	1:05 PM	W	7	1	1	No	N/A		ML		N/A	N/A
4- Millmont Dr	1:12 PM	N-NW	3-9	1	1	Yes	11	6	EA	Garbage	2	-1
	1:12 PM	N-NW	3-9	1	1	Yes	8	11	AP	Garbage	3	-1
	1:16 PM	N-NW	4	1	1	Yes	14	4	ML	garbage	2	-1
5- Marilyn Dr	1:35 PM	N-NW	3-9	1	1	No	N/A		EA	Onion	1	0
	1:35 PM	N-NW	3-9	1	1	No	N/A		AP	Vegetable	1	0
	1:37 PM	N-NW	2	1	1	No	N/A		ML		0	0
6- Zanker Rd	1:55 PM	NW-W	7-12	1	1	No	N/A		EA	Grassy	0	0
	1:55 PM	NW-W	7-12	1	1	No	N/A		AP	Grassy	0	0
7- Renaissance Dr	2:15 PM	N-W	5-13	1	1	No	N/A		EA		N/A	N/A
	2:15 PM	N-W	5-13	1	1	No	N/A		AP		N/A	N/A

2. Precipitation: None (1), fog (2), light rain (3), rain (4)  
 3. Odor Character: eg. earthy, musty, rotten egg, urine, sour, ammonia, sweet, chemical, fishy, seaweed, agricultural, superphosphate, and other (please state)  
 4. Odor Intensity: Not Detectable (0), Very Weak (1), Weak (2), Distinct (3), Strong (4), Very Strong (5), Extremely Strong (6)  
 5. Hedonic Tone: Pleasant (1), Neutral (0), unpleasant (-1), revolting (-2), nauseating (-3)

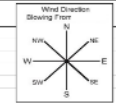

## **Appendix C**

### **Example Quote of a Facility Ongoing Odor Monitoring System**



**JACOBS  
MILPITAS PROJECT**

**Mr. Bart Kraakman**

**Mr. Scott Cowden**  
-----

October 7<sup>th</sup>, 2021

**Quotation Ref.** JACOBS MILPITAS - CUSTOMER REQUEST 10/5/2021

**Subject:** Technical proposal for JACOBS Americas for Real Time Monitoring of multiple sites and sources in the Milpitas/ California geographical Area

Dear Sirs,

Further to your request, please find attached our technical proposal regarding the operational environmental monitoring of the three facilities plus the city area.

This proposal describes the full offer for the hardware and software solution but not the physical, electrical and connectivity installation.

We hope that this proposal meets your request, and we remain at your disposal for any further information that you may need.

Yours faithfully,

Jean Christophe Mifsud PhD

RUBIX Senses & Instrumentation

# Technical Proposal

## MILPITAS

- Newby Island Landfill
- Zanker Recycling
- San Jose – Santa Clara Regional Wastewater Facility

Location: MILPITAS/ California

## Environmental and Process Monitoring for Environmental Industries and the City of Milpitas

Technical Proposal	To
<p><b>Reference:</b> JCM-09232021-JACOBS N°001</p> <p><b>Date:</b> October 7th, 2021</p> <p><b>Contact:</b> Jean Christophe Mifsud RUBIX SI President &amp; CEO Tel. : +33 6 07 42 74 81 <a href="mailto:Jean.christophe.mifsud@rubixsi.com">Jean.christophe.mifsud@rubixsi.com</a></p>	<p><b>Mr. Bart Kraakman</b> (<a href="mailto:bart.kraakman@jacobs.com">bart.kraakman@jacobs.com</a>)</p> <p><b>Mr. Scott Cowden</b> (<a href="mailto:scott.cowden@jacobs.com">scott.cowden@jacobs.com</a>)</p>

### IMPORTANT

This document describes the WT1 monitoring proposed solution. For easier reading, this solution will be hereafter referred to as “WT1 Solution”.

### COPYRIGHT

RUBIX SI – All rights reserved.

RUBIX SI is a registered trademark.

All the other trademarks are the property of their respective owners.

**CONTENTS**

- 1. PROJECT SUMMARY ..... 5**
  - 1.1 OBJECTIVE..... 5
  - 1.2 PROPOSED SOLUTION ..... 5
- 2. PROJECT CONTEXT ..... 6**
  - 2.1 COMPONENT A: IMPLEMENTATION OF A NETWORK OF ENVIRONMENTAL ANALYZERS..... 7
    - 2.1.1 *Proposed Equipment and Configuration* ..... 7
    - 2.1.2 *Proposed Locations for analyzers*..... 7
    - 2.1.3 *Data visualization and analyses* ..... 13
  - 2.2 COMPONENT B: ODOR INTENSITY ASSESSMENT ..... 13
    - 2.2.1 *Proposed Approach* ..... 13
  - 2.3 COMPONENT C: ODOR IDENTIFICATION ASSESSMENT ..... 13
  - 2.4 COMPONENT D: ODOR DISPERSION ANALYSIS (OPTIONAL) ..... 13
  - 2.5 COMPONENT E: SAMPLING (OPTIONAL) ..... 13
  - 2.6 COMPONENT E: DATA PROCESSING AND ANALYSIS (OPTIONAL)..... 14
- 3. RUBIX WT1 + RUBIXSOFT SOLUTION - IN BRIEF ..... 15**
- 4. CONSIDERED SOLUTION ..... 16**
- 5. WHY USING THE WT1 SOLUTION? ..... 19**
- 6. EXPERTISE AND REFERENCES..... 20**
  - 6.1 RUBIX SI ..... 20
  - 6.2 EXPERTISE AND REFERENCES..... 20
- 7. INTRODUCING THE WT1 SOLUTION ..... 21**
  - 7.1 GLOBAL ARCHITECTURE..... 21
  - 7.2 ONLINE FIELD MONITORING ..... 22
    - 7.2.1 *Analyzer WT 1* ..... 22
    - 7.2.2 *RubixSoft* ..... 23
    - 7.2.3 *Sensory Perception Surveys (via QR code tags)*..... 25
  - 7.3 ODOR INTENSITY AND ODOR QUALITY ASSESMENT ..... 27
  - 7.4 MODELLING APPROACH ..... 34
- 8. PROJECT MANAGEMENT ..... 36**
  - 8.1 DEPLOYMENT STUDY ..... 36
  - 8.2 PROFESSIONAL SERVICES..... 37
    - 8.2.1 *Installation - Training* ..... 37
    - 8.2.2 *Customized analysis optimization services*..... 38
    - 8.2.3 *Analytical services* ..... 38
- 9. SCHEDULE ..... 39**
- 10. BUDGET ..... 40**
- 11. WARRANTY ..... 42**

**TABLE OF ILLUSTRATIONS**

Tables

BOARD 1 - ELEMENTS OF THE MONITORING CENTER INCLUDED IN THIS OFFER ..... 16  
BOARD 2 - ANALYZERS INCLUDED IN THIS OFFER..... 17  
BOARD 3 - SERVICES INCLUDED IN THIS OFFER..... 18  
BOARD 4 - CUSTOMER REFERENCES ..... 20

Figures

FIGURE 1: GENERAL SCHEME OF COMMUNICATION BETWEEN THE DEVICE, WT1 AND OUR CLOUD PLATFORM ..... 13  
FIGURE 2 – WT1 SOLUTION IN SHORT ..... 15  
FIGURE 3 - GLOBAL ARCHITECTURE OF WT 1 ..... 21  
FIGURE 4 - MAP CONTROL OF ODOR CONCENTRATION (UOE.M-3) ..... 24  
FIGURE 5 – E.G., CONCENTRATION CURVES FOR H2S, NH3, VOC (PPM) ..... 24

# 1. PROJECT SUMMARY

## 1.1 OBJECTIVE

The aim of the project is to determine the contribution and variability of odor nuisances from three facilities close to Milpitas city and as to contribute for the development of a strategy for measuring how often and at what concentrations these potential odors may be passing into the local community.

- JACOBS has already undertaken an odor attribution study to identify specific compounds that may be impacting a local community from the three closely located facilities.

## 1.2 PROPOSED SOLUTION

Based on our previous conversations, we propose the following solution's components:

- Component A: Network of properly located Environmental Analyzers.
- Component B: Odor Intensity Assessment – Our monitoring solution will be able to assess the odor intensity of selected sampling points and express it in OU/m<sup>3</sup> as described in Norm ASTM E679. This component relies on the “training” of our analyzers with a known dynamic olfactometric data set.
- Component C: Odor Quality Assessment - Our monitoring solution will be able to identify odor sources specific “fingerprints” / “signatures”. This will enable to map perceived odors with the originating sources.

Additionally, we submit to your consideration:

- Component D: Odor Dispersion Analysis and Forecast– thru the implementation of our real-time Odor Dispersion Software Platform.
- Component E: Sampling
- Component F: Data Analysis



## 2. PROJECT CONTEXT

Odor has been an issue in this area for decades. Over the years, various odor mitigation approaches have been undertaken with varying degrees of success. While the number of odor complaints from residents has decreased in recent years from a peak of 3,500 in 2015, the high number of complaints (1,500) reported for 2018 indicates a persistent and ongoing odor issue. The odors in the area originate primarily from three closely located facilities including:

- Facility A: An Anaerobic Organic Material Digestion Facility
- Facility B: A Waste Recycling Facility  
(Waste recycling facility, composting facility, and a landfill)
- Facility C: A Wastewater Treatment Facility,

while other natural sources were also considered (lift stations, bay, estuary).

### Map of the Area

Here under, an overview and a regional map of the Milpitas Area, indicating the facilities, production buildings / facilities and a relatively close location against neighboring communities.



## Proposed Solution

### 2.1 COMPONENT A: IMPLEMENTATION OF A NETWORK OF ENVIRONMENTAL ANALYZERS

#### 2.1.1 PROPOSED EQUIPMENT AND CONFIGURATION

Our solution will consist of a dedicated network of Rubix WT1 (WATCH TOWER 1) Environmental Analyzer Units to monitor each of the three facilities and the city. We will provide two specific configurations:

- Production Sites WT1 Analyzer’s configuration (each unit):
  - o Odors signature configuration – including the following sensors:  
4 Metal Oxide Sensors (MOS)  
Total Volatile Organic Compounds (TVOC)/ PID Sensor  
Mercaptan/ Total Reduced Sulfur (TRS)  
Ammonia
  
- Milpitas City WT1 Analyzer’s configuration (each unit):
  - o Odors signature configuration – including the following sensors:  
4 Metal Oxide Sensors (MOS)  
Total Volatile Organic Compounds (TVOC)/ PID Sensor  
Mercaptan/ Total Reduced Sulfur (TRS)  
Ammonia
  - o City air pollution configuration – including the following sensors:  
Nitrogen dioxide (NO2)  
Particulate matters (PM10, PM2.5 and PM1)  
Ozone (O3)  
SO2

Additionally, the capability of Sensory Perception Surveys (via QR code tags) is included.

Collecting real- time perceptions and sensory data of customers or employees, exposed to a given environmental event, allows to capture this critical data into the platform processing.

#### 2.1.2 PROPOSED LOCATIONS FOR ANALYZERS

To provide a robust and detailed monitoring of odors in the study domain, we suggest the implementation of 17 WT1s (as shown in the following maps). The implementation we propose is based on the information provided by JACOBS including:

- The description of the odor sample collection and methods used
- The characteristics of the facilities including:
  - o the key odor sources: odor intensity, hedonic tone and odor description

- the odor activity values and the odor potency/importance regarding a list of odorant chemical compounds and thresholds
- ⊃ The odor impacts in the community including:
  - Odor contributions based on initial in-field odor olfactometric assessments
  - Odor complains database from the last 5 years
- ⊃ The local climate and prevailing wind directions

Note that these locations may require to be adjusted / modified once the solution is deployed in the field in case of logistic constrains (power supply, etc.).

- Facility A: Anaerobic Organic Material Digestion Facility - Zanker Recycling

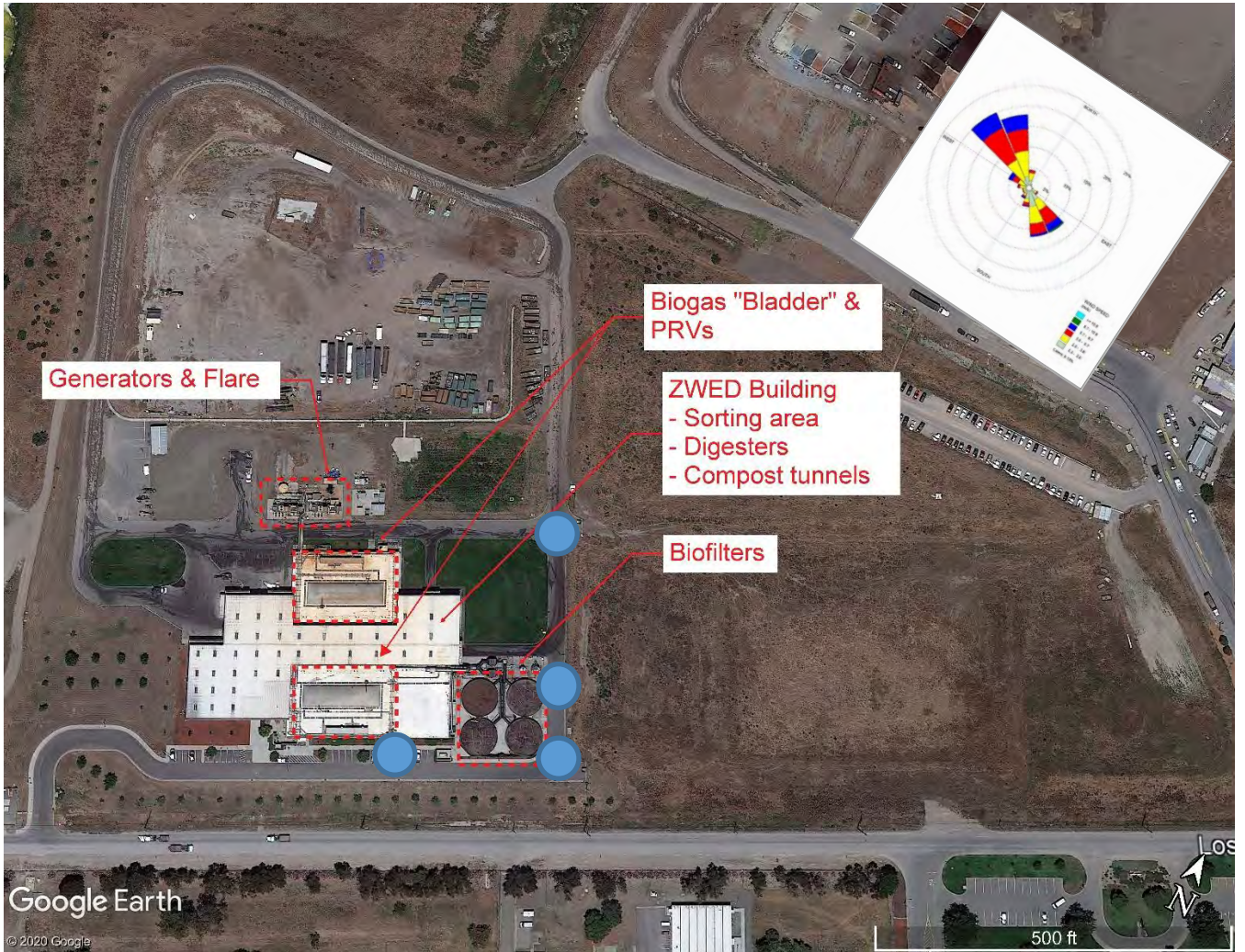

WT1 - Analyzers

- Facility B: A Waste Recycling Facility - Newby Island Landfill



  
WT1 - Analyzers

- Facility C: A Wastewater Treatment Facility- San Jose/ Santa Clara Regional Wastewater Facility

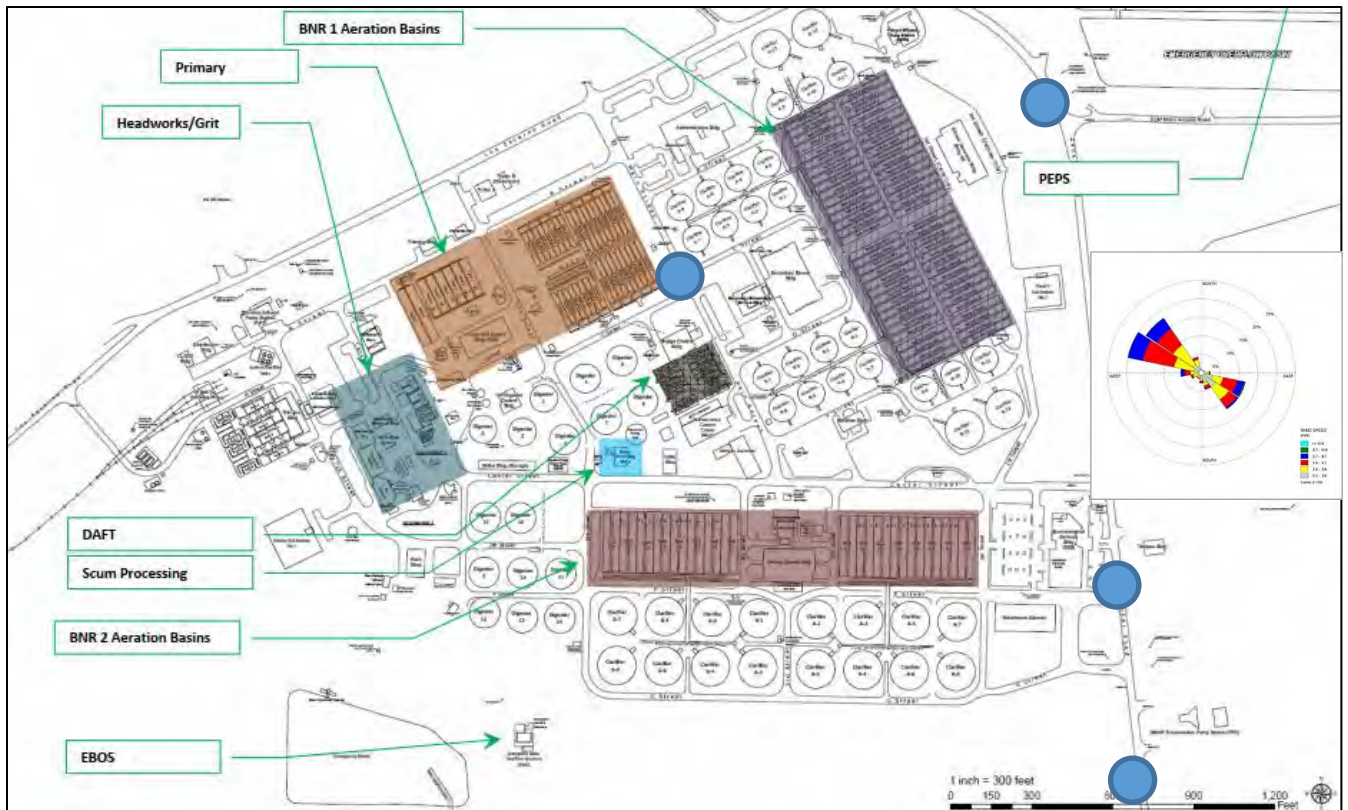

WT1 - Analyzers

- City of Milpitas:



WT1 - Analyzers

### 2.1.3 DATA VISUALIZATION AND ANALYSES

## 2.2 COMPONENT B: ODOR INTENSITY ASSESSMENT

### 2.2.1 PROPOSED APPROACH

Analyzers will provide the actual odor intensity (expressed in OU/m<sup>3</sup>) as described in Norm ASTM E679.

The result is that the Analyzers will be able to behave as an “additional panel member” reflecting the values in the RubixSoft platform.

To do so the Analyzers will be trained using a data model built out of existing Dynamic Olfactometry data (not provided)

- We propose to include this feature to all deployed WT1 Analyzers.

Methodology is described in Page 24.

## 2.3 COMPONENT C: ODOR IDENTIFICATION ASSESSMENT

The monitoring solution will be able to identify odor sources specific “fingerprints”/ “signatures”. This will enable to map perceived odors with the originating sources.

- We propose to develop fingerprints for all relevant sources of the three sites (target of total 12 sources)

Methodology is described in in Page 27.

## 2.4 COMPONENT D: ODOR DISPERSION ANALYSIS (OPTIONAL)

WT1 analyzers can provide the required data for the deployment of one or several Dispersion Plume Analysis

## 2.5 COMPONENT E: SAMPLING (OPTIONAL)

The WT1 analyzers can act as a reliable sample “triggering” device, when a certain threshold of a measured event is reached. The WT1 Analyzer will identify the selected threshold being surpassed and automatically trigger a sampling action like with the utilization of bags. The unit includes a 4-20mA standard connector that will be used to connect with the sampling unit.

- We propose to implement a sampling mechanism in some or all the 5 WT1 located in the city



## 2.6 COMPONENT E: DATA PROCESSING AND ANALYSIS (OPTIONAL)

Our Environmental Intelligence Platform RubixSoft provides multiple advanced statistical tools and pre-built calculus models that can answer many of the more relevant business information needs.

The development of experimental plans and specific data processing can also be addressed thru dedicated consulting work.

### 3. RUBIX WT1 + RUBIXSOFT SOLUTION - IN BRIEF

WT 1 + RubixSoft is a field solution for the continuous monitoring of gases, odors, noise, liquids, soil and particles designed by RUBIX SI (inspired by mimicking human senses).

Based on microsensor technology (combination of multiple sensors with pattern recognition algorithms), the WT 1 solution provides site operators with a real dashboard for monitoring and identifying several kinds of gaseous emissions, odors, liquids and noises. Modular; the solution can also provide very simple views, in the form of dynamic 2/3D mapping, atmospheric dispersion of emissions in the vicinity of the site and the intensity and quality of any nuisance.

WT 1 is an essential element of nuisance remediation. The system is in fact capable of alerting in real time, of identifying the sources in question and to control the related processes.

This turnkey solution is typically deployed on sites where nuisances are proven or alleged by residents, and on sites subjected to regulations.

The system also allows to trace the perceptions of residents in real time via a Subjective Feedback Survey QR code linked to a specific questionnaire.

## A unique combination of expertise from outdoor to indoor

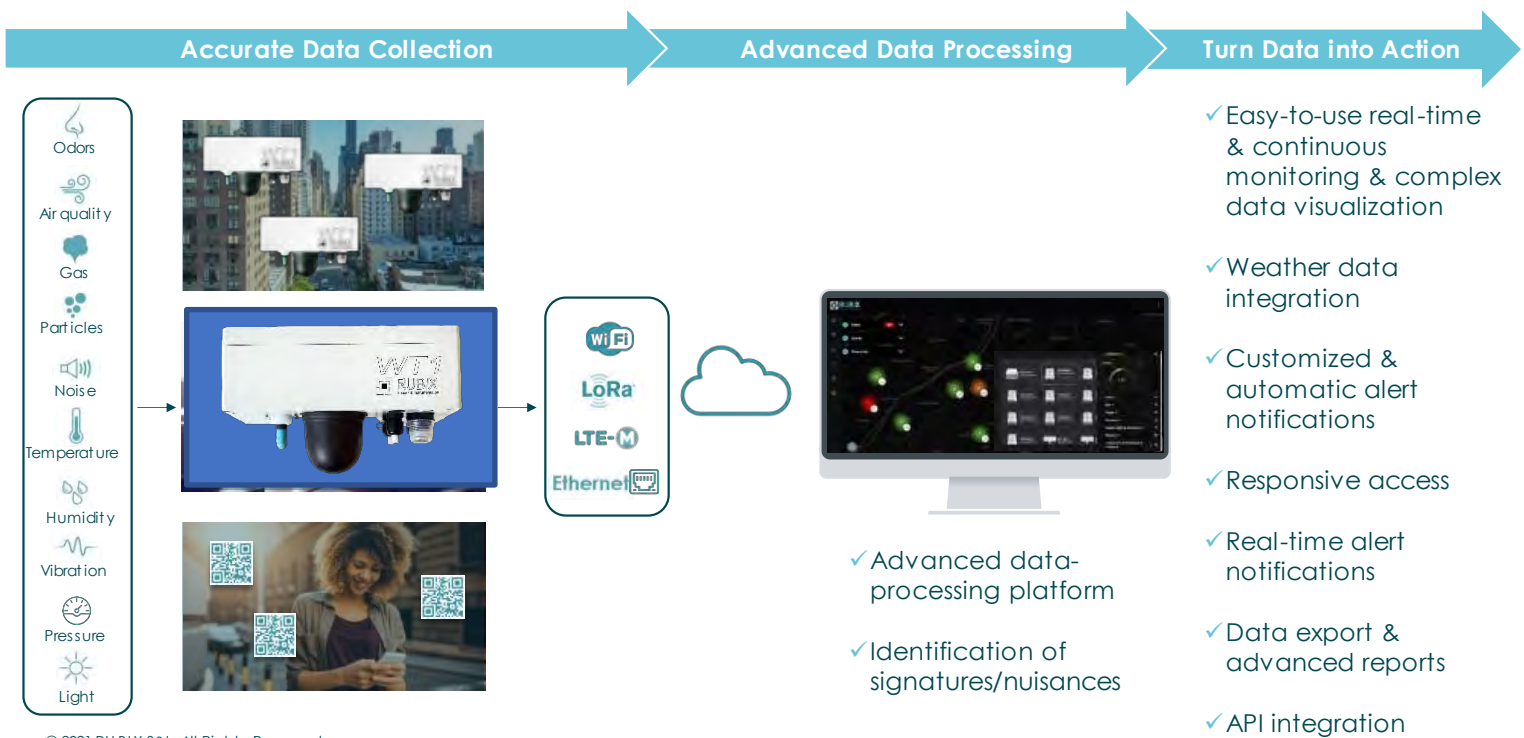

© 2021 RUBIX S&I. All Rights Reserved

## 4. CONSIDERED SOLUTION

The configuration of sources to monitor on your sites is as follows:

### 1. RubixSoft Platform

#### RubixSoft platform



#### Environmental Intelligence Platform

- ✓ Easy-to-use real-time & continuous monitoring & data visualization
- ✓ Identification of signatures/nuisances
- ✓ Weather data integration
- ✓ Customized & automatic alert notifications
- ✓ Multilingual & responsive access
- ✓ Data export
- ✓ Advanced reports
- ✓ API integration

© 2021 RUBIX S&I. All Rights Reserved



- The monitoring solution includes the following:

Qty	Article
1	RUBIX SOFT software

Board 1 - Elements of the monitoring center included in this offer

This allows:

- Continuous monitoring of gas, liquid and odor emissions
- Continuous monitoring of exhaust emissions: VOC (via four MOS sensors), H<sub>2</sub>S, and mercaptans with measurement of air quality (optional (NO<sub>2</sub>, SO<sub>2</sub>, O<sub>3</sub>, CO)
- The recording in real-time of the perception of co-workers and residents (Subjective Feedback Tool included)

- As field measuring devices; the following:

Qty	Article
17	Analyzer (s) WT 1

Board 2 - Analyzers included in this offer

- WT 1 analyzers are positioned related to each emission source, the required operational location and/ or the periphery of the site. Preferably near the corners of the streets in the neighborhood (sniper position)

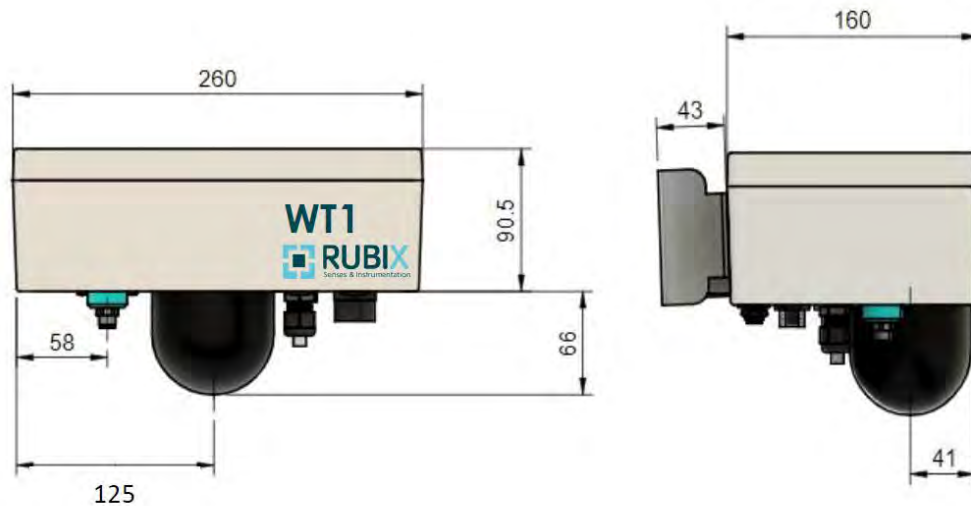

**WT1 - Key Features**

				<p><b>Power</b></p> <p>12V DC input<sup>(1)</sup>, PoE, solar panel battery</p>	<p><b>Compact structure</b></p> <p>IP54 housing &amp; -30°C / + 60°C</p>
<p><b>Real-time</b></p> <p>Data upload every 10 seconds</p>	<p><b>Dynamic</b></p> <p>Double air entry/exit channel for separated gas &amp; PM measure</p>	<p><b>Data logger</b></p> <p>2 years offline permanent on cloud</p>	<p><b>4-20mA switch</b></p> <p>Automatic triggering of remediation</p>	<p><b>Easy installation</b></p> <p>Less than 2 hours /LED button with device status in 7 colors</p>	<p><b>Maintenance</b></p> <p>External USB connector with board data access</p>
<p><b>Connectivity</b></p> <p>WiFi, Ethernet, LTE-M / GPRS</p>	<p><b>Secured</b></p> <p>Data stored in our cloud<sup>(2)</sup></p>	<p><b>Flexible</b></p> <p>IP networked device</p>	<p><b>Geolocation</b></p> <p>Built-in GNSS (GPS/ Galileo/ Beidou/ Glonass)</p>	<p><b>Dispersion plume</b></p> <p>Real time &amp; historical neighborhood impact</p>	<p><b>Firmware</b></p> <p>Remote configuration and maintenance</p>

<sup>(1)</sup> 110-240V AC - 12V DC power adapter  
<sup>(2)</sup> Permanent back-up on cloud

© 2021 RUBIX S&I. All Rights Reserved



To support the deployment of these Analyzers, our offer includes the following services:

Benefit	Descriptive
<b>Location Analysis</b>	<p>This study sets the optimal location of the measurement device pattern.</p> <p>Our offer includes the completion of the following studies, whose results will be used as part of the implementation study:</p> <ul style="list-style-type: none"> <li>▪ One odor intensity data bank built for each WT1 based on RUBIX OU data processing</li> <li>▪ No olfactometry studies are included in the quotation</li> </ul>
<b>Installation</b>	<p>The system will be implemented at your site. The installation is preceded by a pre-visit for identifying the technical information and verify the essential prerequisites for the smooth running of the facility. Installation will be performed by RUBIX Distributor with the initial installation training and support of RUBIX Team. Installation cost needs to be specifically quoted.</p>
<b>Training</b>	<p>Your team or your customer’s team will be trained by RUBIX Team</p>
<b>Configuration</b>	<p>Instruments will be deployed and provisioned at the RubixSoft platform reaching full functionality.</p> <p>Initial phase called "learning" that "teaches" the system to be able to "feel" on the scale of human perception. For this, the system is configured using a learning model odor source made by RUBIX</p>

Board 3 - Services included in this offer

## 5. WHY USING THE WT1 SOLUTION?

By acquiring a WT 1 based solution you will be able:

- To continuously monitor emissions (gases, odors, liquids, noise) from any internet connected device
- Identify sources of pollution and their recognition (via signatures after specific training)
- To know at any time the odor emission levels (scale RUBIX) and gaseous pollutants produced by your facilities
- Identify the type of odors associated with sources after learning and measure the intensity of gas and odors online
- View very simply the dynamically projected emission dispersion in the vicinity of the site, considering local weather conditions and topography of the site, (optional)
- Know at any time if the surrounding residential areas are impacted and understand nuisance levels
- To obtain objective data to facilitate communication with residents, associations and authorities,
- To better understand the phenomena inherent to the "odor", gas, liquid and particles problem from your site
- To be alerted as to implement the necessary measures when the concentrations of odor or pollutants exceed the thresholds and are outside the area of acceptability,
- Anticipate nuisance and treating emissions before they impact the neighborhood,
- Reduce water consumption, additives and energy of your treatment systems:
  - by driving them to be automatically triggered
  - proper additive management correlated with the measured concentration,
- To evaluate the attenuation odor factor of your processing facilities,
- Strengthen regulatory compliance, if your facility is subject to regulation recommending the establishment of a continuous monitoring of odor emissions,
- To have historical emissions data of your site,
- Strengthen your continuous improvement approach by equipping your site with advanced technologies for odor monitoring.

## 6. EXPERTISE AND REFERENCES

### 6.1 RUBIX SI

RUBIX SI designs and markets instruments and analysis solutions by chemical fingerprint. The company offers a complete range of solutions and services including scanners, services, chemical and sensory analysis laboratory and customized industrial solutions.

RUBIX SI solutions are marketed directly via the head office in France and distributors abroad.

To learn more: [www.rubixsi.com](http://www.rubixsi.com)

### 6.2 EXPERTISE AND REFERENCES

Pioneer of analyzer and multisensory analyzers, RUBIX SI puts its expertise and know-how at the service of the environment. An internal expertise center dedicated to environmental and odor problems related to industrial activities working closely with institutional partners to develop and validate solutions:

- **TOTAL**
- **ENGIE**
- **SUEZ**
- **VEOLIA**
- **IRSN**
- **PARIS, AMSTERDAM, MILANO, LONDON AIRPORTS**
- **RIGA SEAPORT**
- **WALMART**
- **WESTRAND**
- **CECO**

Board 4 - Customer references

## 7. INTRODUCING THE WT1 SOLUTION

### 7.1 GLOBAL ARCHITECTURE

The WT 1 consists of a measuring device in the field and a RubixSoft Platform/ monitoring center.

The continuous measurement of concentrations of odor, liquid and gaseous pollutants is enabled by the networked analyzer WT1 placed at the sources of emissions. These can be of different types: channeled, surficial, volumetric. For channeled sources, the analyzer WT 1 is completed upstream by a DnD system ensuring the collection, drying and dilution sample gas.

The monitoring center, internet connected PC, smart phone, tablet, allow the user to easily visualize all the information on the monitoring of the site emissions. The cloud hosts the data processing necessary for the recording and processing of data from the measuring device.

Data transmission between the implanted device in the field and the monitoring center is provided by an ethernet cable or a wireless communication system (3G/4G or Wi-Fi).

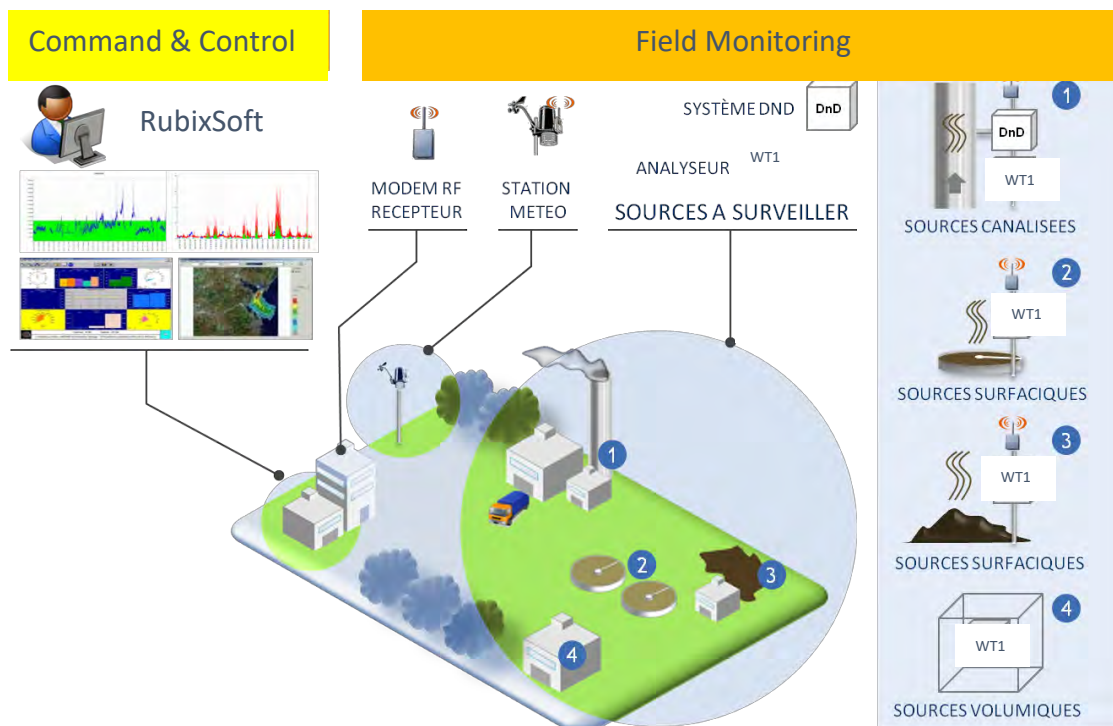



figure 3 - Global architecture of WT 1



## 7.2 ONLINE FIELD MONITORING

### 7.2.1 ANALYZER WT 1

ITEM	PROVIDED IN THIS OFFER
<b>ANALYZER WT 1</b>	<b>17 units Included</b>

DESCRIPTION	
	<p>WT 1 analyzers contain an array of multiple sensors. They are located strategically at the odor sources to measure 24/7 the odor emission levels, noise, liquid, particulate and gaseous pollutants.</p> <p>The measurement results are communicated thru the RubixSoft Platform</p>
FEATURES	
<ul style="list-style-type: none"> <li>▪ Continuously scanning the emission source</li> <li>▪ Continuous measurement of gaseous pollutants to the emission source               <ul style="list-style-type: none"> <li>○ Electrochemical</li> <li>○ Four MOS sensors</li> </ul> </li> <li>▪ Liquid measurement</li> <li>▪ Transmission (Ethernet, GPRS)</li> <li>▪ Alarm and Notifications</li> </ul>	
ADVANTAGES	
<ul style="list-style-type: none"> <li>▪ Operates in routine mode without user intervention</li> <li>▪ Monitoring adapted to any type of source               <ul style="list-style-type: none"> <li>○ Channeled: chimneys, exhaust duct, etc.</li> <li>○ Surface: pools, storage areas, biofilters, etc.</li> <li>○ Gravity: buildings, sheds, etc.</li> </ul> </li> <li>▪ Use inside buildings or outdoors (IP55)</li> <li>▪ Sensory and physicochemical monitoring</li> <li>▪ Easy integration with wireless communication</li> <li>▪ Continuous monitoring (data points each 10 seconds)</li> </ul>	

7.2.2 RUBIXSOFT

ITEM	PROVIDED IN THIS OFFER
<b>SOFTWARE RUBIX SOFT</b>	<b>Included</b>

DESCRIPTION	
	<p>The web- and cloud-based RubixSoft continuously tracks, identifies and assess changes in concentrations of odor, liquids and gaseous pollutants from different sources emissions.</p> <p>The software may also control an external system to alert or manage the operation of a treatment installation when the measured values exceed the configured thresholds (using the WT1 4-20 mA connector)</p>
FEATURES	
<ul style="list-style-type: none"> <li>▪ <b>Data acquisition and processing</b> <ul style="list-style-type: none"> <li>○ Continuous monitoring of concentration for each emission source                             <ul style="list-style-type: none"> <li>- Odor concentration</li> <li>- Identification of sources (training required)</li> <li>- Concentration of pollutant gases: VOC, H2S and mercaptans</li> </ul> </li> <li>○ Displaying the form of graphs, control charts or tables</li> <li>○ Calculating the outliers' frequency</li> </ul> </li> <li>▪ <b>Automated Steering of external systems (option set)</b> <ul style="list-style-type: none"> <li>○ Definition of thresholds for triggering</li> <li>○ Control of odor treatment facilities</li> <li>○ Trigger warning systems: rotating beacon, siren, etc.</li> <li>○ Triggering of Sampling system</li> </ul> </li> <li>▪ <b>Calibration management</b> <ul style="list-style-type: none"> <li>○ Calibration wizard</li> </ul> </li> <li>▪ <b>Traceability</b> <ul style="list-style-type: none"> <li>○ Historical series - searchable</li> <li>○ Journal of interventions on the system (logbook)</li> <li>○ Data Archiving</li> </ul> </li> <li>▪ <b>Export data to spreadsheet</b></li> <li>▪ <b>Two patterns of use:</b> Routine mode and expert mode</li> <li>▪ <b>Configuration of system settings</b> (Communication modems, frequency analysis, language, etc.)</li> </ul>	
EXAMPLES OF USER INTERFACE	



figure 4 - Map control of odor concentration (uoE.m-3)

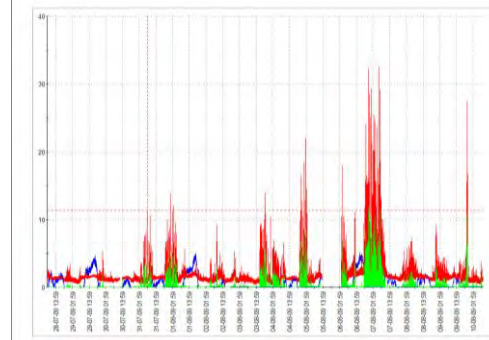



figure 5 – e.g., Concentration curves for H<sub>2</sub>S, NH<sub>3</sub>, VOC (Ppm)

### ADVANTAGES

- Remote access, away from emission sources
- Odor/ Gas/ Liquid strength measurement correlation
- Help with the decision for the implementation of preventive and / or corrective
- Communication with local stakeholders based on objective measures of events
- Clear Results, easily interpretable
- Quick analysis results with a graphic display and automatic calculations
- Seamless integration with warning or remediation systems
- Water/ additives consumption and reduced products through optimized operation of treatment facilities
- Simplified maintenance
- Traceability
- Flexible and configurable system
- Multilanguage Interface (English, Spanish, German and French included)

7.2.3 SENSORY PERCEPTION SURVEYS (VIA QR CODE TAGS)

ITEM	PROVIDED IN THIS OFFER
<b>7.2.3 SENSORY PERCEPTION SURVEYS</b>	<b>Included</b>

DESCRIPTION
<div style="display: flex; align-items: flex-start;">  <p>Collecting real time perceptions and sensory data of customers or employees, exposed to a given environment, combined with the analytical and quantitative data collected from RUBIX devices (POD2, WT1, etc.), allows to better understand the impact of different nuisances (odors, gas, noise, light, etc.) and to develop more effective remediation systems, for improved overall wellbeing.</p> </div>
WORKING PRINCIPLES
<ul style="list-style-type: none"> <li>▪ <b>Each RUBIX device has its own QR code and is assigned to a specific zone</b></li> <li>▪ <b>QR code gives access to an on-line customized questionnaire</b></li> <li>▪ <b>Up to 10 different questions per questionnaire</b></li> <li>▪ <b>Answer type can be Boolean or a value (graduated cursor)</b></li> <li>▪ <b>All answers are anonymous</b></li> <li>▪ <b>An Air Quality SQC will be created after a full cycle of activity as a reference</b></li> <li>▪ <b>A correlation model will be built between the analytical data from POD or WT1, and the sensory data from QR codes</b></li> <li>▪ <b>Based on the model, the devices will automatically trigger adequate remediation systems (filtration, ventilation, etc.)</b></li> </ul>

### Customer Use Case Example (Odors Problem)

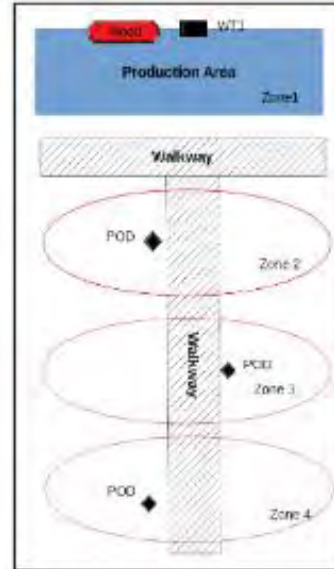

### 7.3 ODOR INTENSITY AND ODOR QUALITY ASSESMENT

DESIGNATION	PLANNED OFFER IN THIS
<b>ODOR SOURCES QUANTIFICATION with RUBIX OU</b>	<b>Included</b>

DESCRIPTION
To measure odor intensity, RUBIX devices can be trained with the RUBIX OU methodology This simple methodology allows you to set easily and rapidly alarms in terms of odor/TVOC level and is unique to RUBIX devices. It can be handled by customer or ordered from RUBIX team as an option.
METHODOLOGY
<p>RUBIX OU is based on an analysis of the combined variation of several MOX TVOC sensors (4 sensors in RUBIX devices) during a training period corresponding to a standard operation phase of the odor source or of the various odor sources if measurements are made at the fence line.</p> <p>A statistical treatment of the variations of the sensors allows to create clusters. Inside the cluster, odor level is considered to be acceptable and normal (e.g., less than 5 OU at the fence line), and outside the cluster, odor level is considered to be higher than the normal situation and an alarm can be triggered.</p> <p>The configuration is performed in two stages:</p> <p><b>1. Observation Period</b> For 15 days, the system operates continuously: the nose detects odors on your site, but the intensity measured is not necessarily well correlated with human perception.</p> <p><b>2. Default Template Adjustment</b> To integrate the specificities of your site, our teams adjust the learning default template based on instrumental measurements performed during the observation phase and on your feedback collected during the same period: reports of odor from the neighborhood, current operations on the site, etc.</p> <p>Then we applied our algorithms according to the following phases:</p> <ul style="list-style-type: none"> <li>= Phase 1: Sensor’s variation analysis</li> <li>= Phase 2: Clustering of the variations using Principal component</li> </ul>



- Phase 3: On-going analysis of the vectors represented by a combination of the 4 sensors

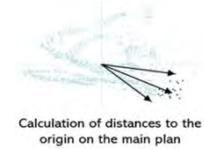

- Phase 4: setup of a control card which variations correspond to the reference cluster variations, thus allowing a time analysis and detection of events with SQC

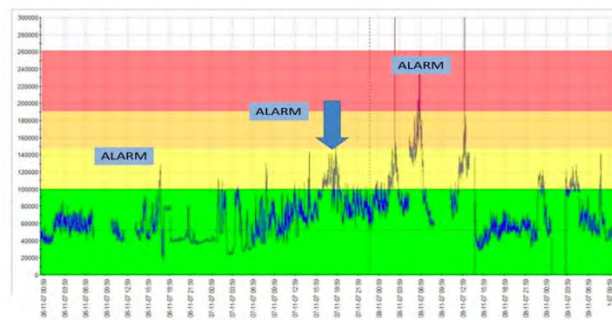
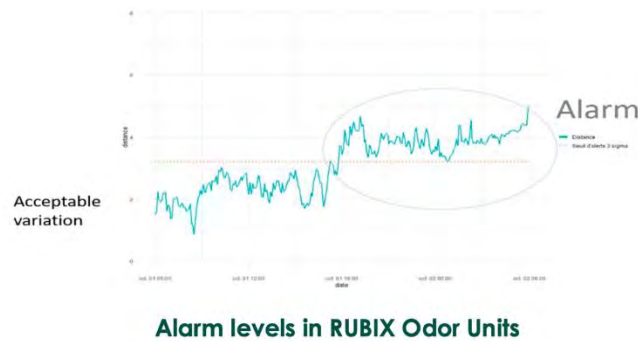

### ADVANTAGES

- Real-time analyses of odor levels at the fence-line, close to the source and in the environment.
- Setup of alarms for exceeding odor levels of 1 UO/m<sup>3</sup> or 5 UO/m<sup>3</sup> specific to the environment of the studied site.
- Inexpensive solution as no olfactometric campaign is required

DESIGNATION	PLANNED OFFER IN THIS
<b>ODOR SOURCES QUANTIFICATION based on pre-existing Dynamic Olfactometry Data</b>	<b>Included</b>
<b>ODOR SOURCES IDENTIFICATION based on on-site training (Sources Fingerprinting)</b>	<b>Included</b>

DESCRIPTION
<p>Once installed, the system must be configured to make truly operational continuous measurement of odor concentration.</p> <p>Also called "learning", this configuration step is to "learn" electronic nose "feel" on the scale of human sensory perception. We use two metrics:</p> <ol style="list-style-type: none"> <li>1. Odor intensity: Based on leveraging ASTM E679/EN 13725 available data. The Analyzer will be trained to understand the actual quantity scale and thus recognize norm related Odor Units levels.</li> <li>2. Source identification: Sources Fingerprinting is the capability of graphically representing a given odor or event. Thru this technique a source specific graphic is built. This allows to clearly differentiate sources. A given data point can be mapped back into the fingerprint and thus allow to identify its origin.</li> </ol> <p>After completing this process, the system can translate accurately measuring instrumental in odor concentration correlated with human perception.</p>
METHODOLOGY
<p>The system configuration is performed in two phases:</p> <ol style="list-style-type: none"> <li>1. Observation Period</li> </ol> <p>For 15 days, the system acquires continuous measurement data necessary for its configuration: the nose continuously detects odors on your site, but the intensity measured is not necessarily well correlated with human perception, the electronic nose is "not yet" educated".</p> <ol style="list-style-type: none"> <li>2. Configure the learning model</li> </ol> <p>To "educate" the electronic nose, our teams develop a mathematical model ensuring permanent translation of instrumental measure odor concentration correlated with human perception. The construction of this learning model is based on instrumental measurements performed during the observation phase and the results of the study already carried olfactometric on your site: our teams establish the correlation between the measurements supplied by the WT 1 and concentrations of odor from the olfactometric study.</p> <p>Once the established model, the system operates autonomously and continuously delivers an odor concentration measurement correlated to human perception.</p> <p>Processes involved in the phase 2 can be summarized in the following figure (steps are described in the following paragraphs).</p>





Step 1 – Odor sampling collection

**Screening of potential odorous sources on site**

A preliminary study with the WT1 consists in sampling the air emitted by the different sources to characterize their respective chemical signature and to evaluate if these fingerprints are close or different. This sampling can be done in two ways depending on the size of the site or the number of sources.

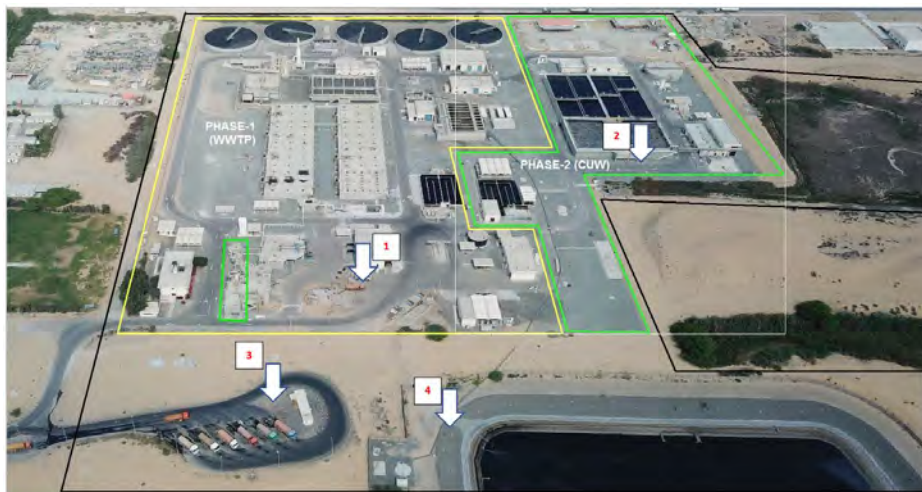

**Olfactometric campaign**

An olfactometric campaign (under ASTM E679/EN 13725) are then performed according to the screening of potential odorous sources on site, including:

- Planning of the sampling campaign(s) considering protocols, dilution factors, etc. on site.
- Logistics for the shipment and follow-up of the Tedlar bag samples according to the standards
- Training and certification of panel members
- Preparation of samples for olfactometric analysis
- Olfactometric analysis in the laboratory
- Writing olfactometric reports for each sample

Note 1: the fingerprinting is done outdoor, close to each source for several minutes to hours: WT1 can be placed on holder or using mobile means at the maximum activity of the source (depending on industrial process, site activity, complaints, etc.) or for several days/weeks for longer observation (fixed device).

Note 2: As a requirement, measures can be repeated over different period of the day/weeks, depending on the process or site activity, to reflect environmental changes.

Step 2: Feeding - Injection of air fractions from several sources using Tedlar bags.

WT1 can be placed in room under controlled condition (T°C, HR...) or outdoor at a fixed placed. Air samples are injected directly to the device from a Tedlar bag. Bag's sampling can be done onsite at the source using a sampling chamber or a pump. Samples from the site were no odor or nuisance are detected can be injected as a blank to get a baseline to train the device.



Step 3: Sniffing – laboratory measurements and reporting

Step 4: Model building

Once injections are done, recorded data are processed to compare the various source and get a profile:

- Compare source's signature (source mapping)
- Evaluate chemical profiles (gas composition, VOC levels, odor variation)

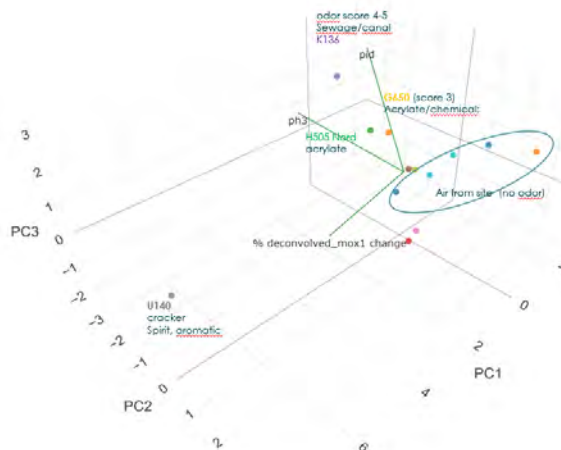

A database can be built to save these profiles in the WT1 and monitor the detection of odors over time.

In complement, chemical composition or quantification by standard analytical methods and olfactory evaluation can be outsourced to evaluate both sensory impact of each source and their potential level of toxicity.

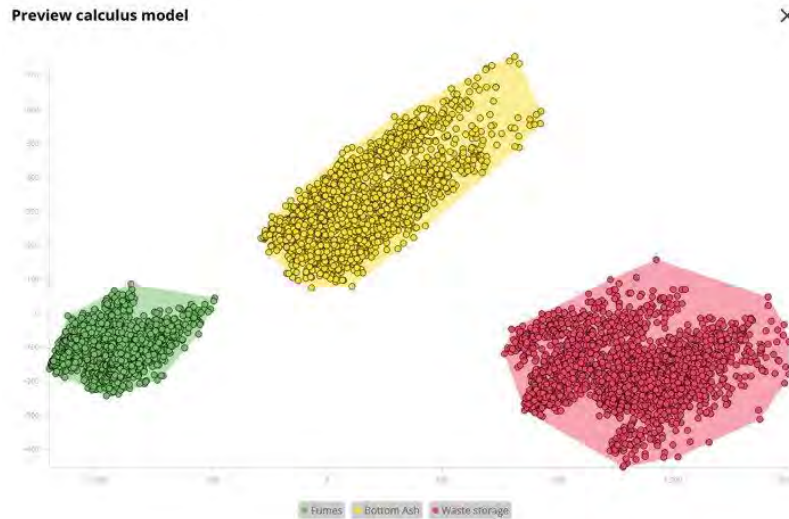

**Step 5: Odor monitoring and Assessment**

Odor models based on previous source screening can be then deployed in a device for online monitoring.

The detection of odor variation or events in the environment is done using Rubix distance odor unit. An alarm is set up to trigger odor identification each time the variation of odor overpasses a threshold limit to perform source identification.





**ADVANTAGES**

- Quantification of odors according to applicable regulations and standards
- Implementation of a source attribution tool bases on in situ odor signatures
- Detection of odor events in real time

## 7.4 MODELLING APPROACH

DESIGNATION	PLANNED OFFER IN THIS
<b>ODOR DISPERSION ANALYSIS AND FORECAST</b>	<b>Optional</b>

DESCRIPTION
<p>We propose a service to evaluate the contribution of the sources from an adapted modeling tool. Based on the gaussian plume model recommended by the US EPA, AERMOD, the dispersion software is a powerful tool for digital 3D simulation of the dispersion of odors and / or polluting gases.</p> <p>The system integrates local weather, emissions of sources of odors, topography and concentrations of odor and / or polluting gases measured by the various sources analyzers WT 1 to model dynamically the plume.</p> <p>The results of the modeling are then used to characterize the contribution of the sources on the events detected by the WT1.</p> <p>The odor plume can also be represented on an aerial view with a color code to immediately assess the impact of emissions on the vicinity of the site. Each color corresponds to a concentration range.</p> <p>Note that various models can be implemented on demand</p>
METHODOLOGY
<p>The following paragraph describes the methodology for source identification and emissions quantification:</p> <p>Step 1: Review of the existing data available to precisely characterize the environment and the site investigated:</p> <ul style="list-style-type: none"> <li>- Air quality and odor measurements</li> <li>- Odor complaints and surveys</li> <li>- Emissions of surrounding industrials</li> <li>- Meteorological dataset</li> </ul> <p>Step 2: Determination of Atmospheric Transfer Factor</p>

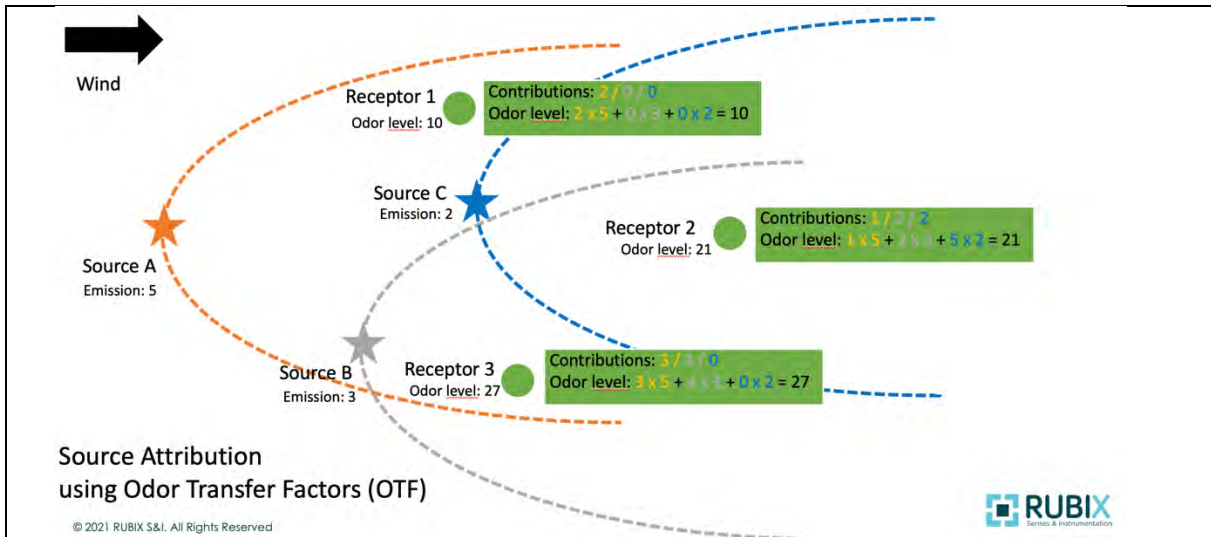

Step 3: Odor monitoring

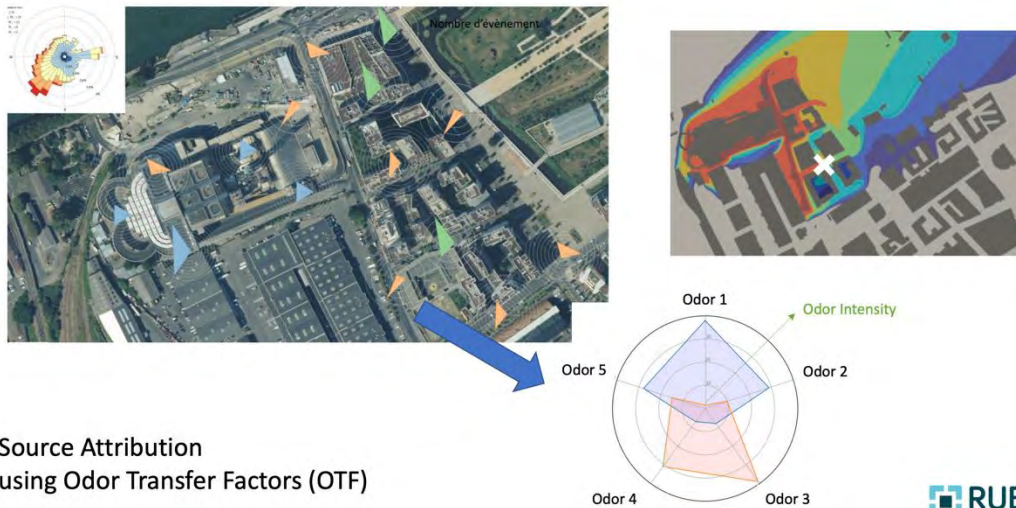

ADVANTAGES

- dynamic visualization and continuous dispersion plume odor and / or pollutant
- retrospective visualization and dynamic episodes from the past for analysis
- automatic generation of daily and monthly reports dispersion
- Optimization of the emissions to reflect measurements

## 8. PROJECT MANAGEMENT

RUBIX SI provides turnkey services for solution deployment.

Our teams consist of environmental experts and skilled technicians involved in every stage of the project, following an effective and proven methodology:

- **Diagnostics** for the definition of the optimal layout diagram of the measuring device,
- **On site** to prepare and complete the installation of equipment,
- **Training** users on site
- **Configuration of the measuring system.**
- **Management of maintenance operations** during routine use of the system

### 8.1 DEPLOYMENT STUDY

Optimal positioning of analyzers provides a good representation of site emissions and their impact. Performed at the beginning of the project, the objective for implantation study to define the optimal layout diagram of the measuring device on your site. This essential step allows to overcome possible interference phenomena or air dilution.

The implementation study is based on the analysis of activity and processes implemented on your site but also on the site environment: location, site map, nearby residential areas, previously identified complaints etc.

If these studies have already been completed on your site, you probably have the information necessary to achieve the implementation study. In this case, and if the site configuration has not changed since the completion of those studies, our teams will use these results to suggest the optimal layout diagram.

Otherwise, we integrate our supply, implementation and monitoring of missing studies.



## 8.2 PROFESSIONAL SERVICES

The services include:

- **Equipment Installation & Training**
- **Customized Analysis Configuration**
- **Analytical Services**

### 8.2.1 INSTALLATION - TRAINING

ITEM	PROVIDED IN THIS OFFER
<b>INSTALLATION &amp; TRAINING</b>	<b>Included</b>

DESCRIPTION
<p>After this service, the system is implemented on your site and your teams are operational for use.</p> <div style="display: flex; justify-content: space-between;"> <div style="width: 25%;">  </div> <div style="width: 75%;"> <p><b>Pre-visit</b> Carried out by our teams, it helps to appreciate the environmental and technical constraints of the site, check the prerequisites and identify technical information essential to the success of the installation.</p> </div> </div> <div style="display: flex; justify-content: space-between; margin-top: 10px;"> <div style="width: 25%;">  </div> <div style="width: 75%;"> <p><b>Installation</b> Equipment and software tools are deployed, configured and tested by the installer. After installation, monitoring of gaseous pollutant emissions is operational and a first estimate of the level of odor intensity is available.</p> </div> </div> <div style="display: flex; justify-content: space-between; margin-top: 10px;"> <div style="width: 25%;">  </div> <div style="width: 75%;"> <p><b>Training</b> Your teams are trained to use the system directly to your installation. Training technically describes the solution and focuses on the use of IT tools and current on maintenance.</p> </div> </div>
CONTENT DELIVERY
<p>Our offer includes:</p> <ul style="list-style-type: none"> <li>▪ The intervention of our technician to install pre-visit</li> <li>▪ The intervention of our technician to install, configure and test the system             <ul style="list-style-type: none"> <li>○ Measuring device</li> <li>○ communication system</li> <li>○ Monitoring Center</li> </ul> </li> <li>▪ Training your staff on-site</li> <li>▪ The provision corresponding intervention reports</li> </ul>



### 8.2.2 CUSTOMIZED ANALYSIS OPTIMIZATION SERVICES

ITEM	PROVIDED IN THIS OFFER
<b>CUSTOMIZED ANALYSIS OPTIMIZATION</b>	<b>Optional</b>
DESCRIPTION	
<p>Customization Analysis is a service that analyzes your customization and data models and runs a predefined set of best practice rules.</p>	

### 8.2.3 ANALYTICAL SERVICES

ITEM	PROVIDED IN THIS OFFER
<b>ANALYTICAL SERVICES</b>	<b>Optional</b>
DESCRIPTION	
<p>The service produces reports that are central for the mitigation/ remediation and prevention. A monthly recurring service can be quoted upon request including the following:</p> <ol style="list-style-type: none"> <li>1- A general synthesis of the project</li> <li>2- A map showing the measurement points and their exact location</li> <li>3- The solution used and its characteristics</li> <li>4- The synthesis of the real-time and continuous measurement conditions considering the environment (meteorological conditions, particular events, etc.)</li> <li>5- The synthesis including the results by measurement points and the interpretation of the results including a summary of the detected odor alerts</li> <li>6- The analysis of the contribution of the activities of the industrial sites</li> <li>7- The comparison to the regulatory values and other reference values (bibliographic values)</li> <li>8- A program proposition with remediation actions to reduce odor emission sources</li> </ol>	

## 9. SCHEDULE

The schedule proposed for the Milpitas City deployment is as follows:



Figure 6 - Schedule

Deployment schedule for the Industrial sites will depend on the actual customer decision cadence.

## 10. BUDGET

This is a budgetary quotation to be replaced by a formal estimate upon request

Component	Description	Unit amount (Ex-works Toulouse/ France)	Expected # of Units
A Network of Environmental Analyzers	WT1 – Analyzer – Industrial Site Configuration (see 3.1.1) (each unit)	€9,180	12
A Network of Environmental Analyzers	WT1 – Analyzer – City Configuration (see 3.1.1) (each unit)	€11,650	5
A Network of Environmental Analyzers	Rubix Software Platform – Subscription (for each individual Analyzer - annual)	€700	17
B & C Odor intensity and odor quality assessment	Consulting support of the model implementation by Analyzer Unit (one time)	€1,200	17
<u>D Odor Dispersion Analysis</u>	<u>Dispersion Plume implementation</u>	TBD	TBD
<u>E Sampling</u>	<u>Provision of Sampling Cases (each)</u>	€6,500	TBD
<u>F Data Analysis</u>	<u>Analytical Services- Customized Reporting (by day)</u>	€1,200	TBD

**Note 1:** For budgetary purposes it can be estimated that the investment required by each of the three Production Sites (with 4 Analyzers with Odor Intensity and Quality Analysis) will be around €44,600 plus €2,800 annually + Shipping and Import Costs from France TBD + Installation Services TBD + Dispersion Analysis (optional) TBD + Sampling Cases (optional) TBD + Data Analysis Services (optional) TBD

**Note 2:** For budgetary purposes it can be estimated that the investment required by the City of Milpitas (with 5 Analyzers with Odor Intensity and Quality Analysis) will be around €72,000 plus €3,500 annually + Shipping and Import Costs from France + Installation Services TBD + Dispersion Analysis (optional) TBD + Sampling Cases (optional) TBD + Data Analysis Services (optional) TBD

## 11. WARRANTY

Rubix SI guarantees that the installed equipment is as described in this document.

Rubix SI shall provide full support during the **guarantee period**, i.e., for **one year from delivery**.

- END OF DOCUMENT -

**Appendix D**  
**Example of Community Odor Bag Sampling Device**

**CITIZEN  
SCIENCE AND  
MULTISENSOR  
TECHNOLOGY TO  
SAMPLE ODOR.**

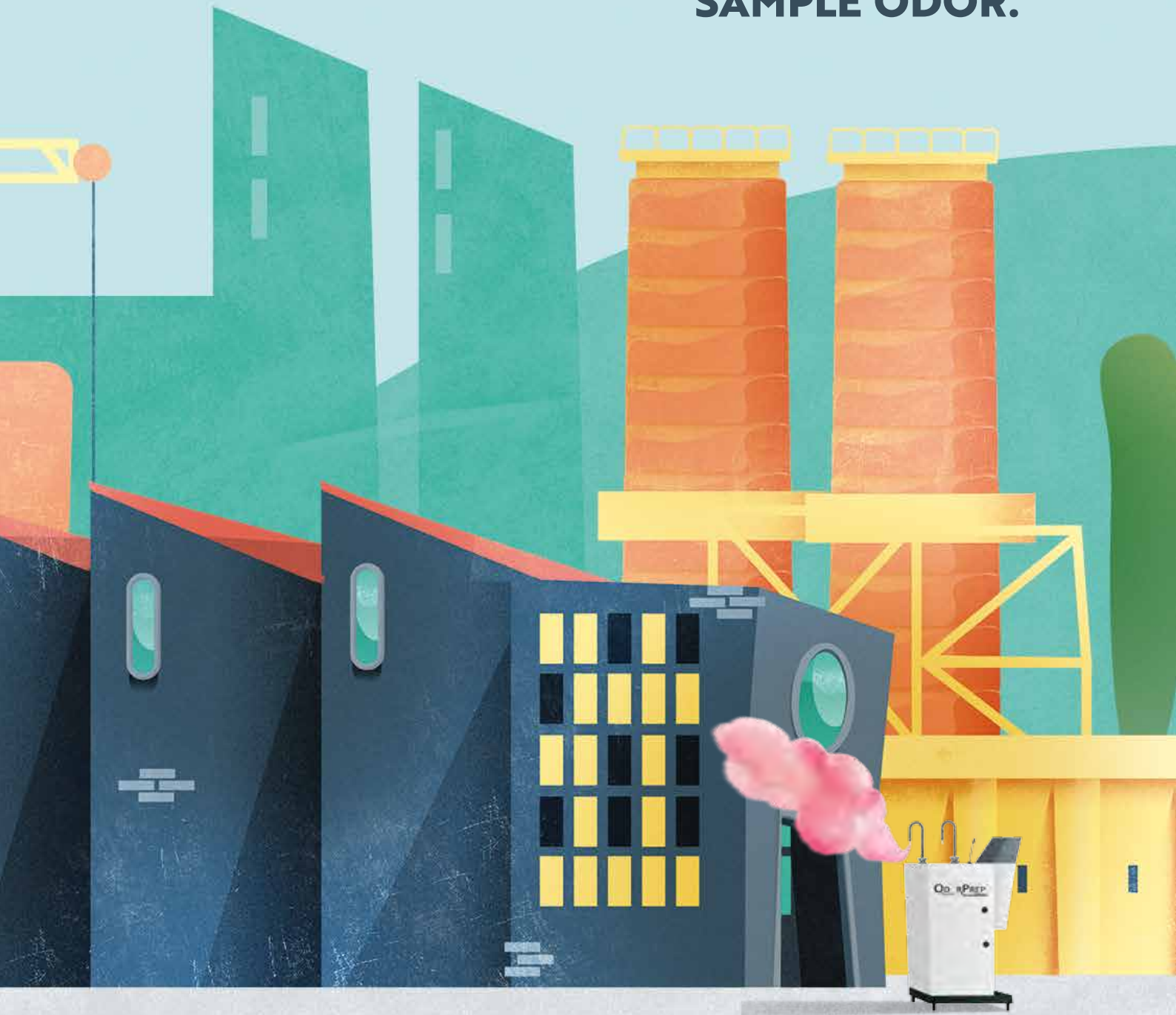

**ODORPREP**<sup>®</sup>  
Automated Odor Emission Sampler

# ODOROUS POLLUTION

A recognized problem





Odour is a form of atmospheric pollution that can cause significant discomfort to people.

Industrial activities, purification systems, landfill sites, waste treatment, farms, agriculture and food industries: these are all sources of odour that risks making difficult the presence of production activities in populated area, creating worries and complaints.

Unfortunately, odour is a complex issue to manage, because of the difficulty for operators to verify the real presence of odour incidents at the moment of inspections and to detect the actual source of emission.

For this reason, it is necessary to perform a timely, objective and documented assessment of the air, in order to allow authorities to intervene for removing the problem.

**IT IS NECESSARY TO PERFORM A TIMELY, OBJECTIVE AND DOCUMENTED ASSESSMENT OF THE AIR.**

## **THE SOLUTION: ODORPREP**

Air of innovation

ODORPREP IS THE ON-DEMAND SYSTEM FOR MONITORING AND SAMPLING AIR.

THE SYSTEM COMPRISES A MOBILE APP THAT ALLOWS REPORTING THE OLFACTIVE TROUBLES IN REAL TIME, AN ON-LINE PLATFORM THAT GATHERS THE INDICATIONS AND VERIFIES THEIR RELIABILITY AND A DETECTION SYSTEM THAT CAPTURES AIR FOR THE LABORATORY CONTROL.



**ODORPREP IS THE ON-DEMAND SYSTEM FOR MONITORING AND SAMPLING AIR.**



# APPLICATIONS

At the service of citizens and companies.



## FOR INSTITUTIONS

**OdorPrep** is installed in the urban areas to be monitored and provides a measurement in real time of odour.

The system collects the incidents reported by citizens via app and activates the air sampling through the detection system. In this way, authorities can intervene to eliminate the problem in a timely manner.

**The cooperation between citizens and institutions, through the use of an innovative technology as OdorPrep represents a positive system to ensure the healthiness of air, to protect the quality of living condition and the psycho-physical wellbeing of citizens.**

### How it works



[View our video](#)



THE CITIZENS REPORT THE PRESENCE OF AN OLFACTIVE INCIDENT VIA THE MOBILE APP.

THE REPORT IS GATHERED INTO AN IT PLATFORM THAT VERIFIES ITS RELIABILITY (ORIGIN, USER'S DATA, FREQUENCY OF REPORTS, ETC.). THE PLATFORM ALERTS THE SYSTEM MANAGER.





THE MANAGER ACTIVATES THE SAMPLING OF THE AIR. THE AIR IS CAPTURED INTO A BAG. THE SAMPLE OF THE AIR IS COLLECTED BY TECHNICIANS AND BROUGHT TO A SPECIALIZED LABORATORY.



THE LABORATORY TECHNICIANS PERFORM THE DYNAMIC OLFACOMETRIC ANALYSIS.

Ph. source: thanks to Olfasense.



THE CONTROL AUTHORITIES, BASED ON ACTUAL RESULTS, INTERVENE TO SORT THE PROBLEMS OUT.



## FOR COMPANIES

To keep the odorous emissions under control, companies can install OdorPrep inside their plant or close to critical processes.

When the electronic nose detects an excess over the threshold values, the sampling begins. The sample is collected by the technicians and brought to a specialized laboratory for the olfactometric analysis.



View  
success story

**In this way, companies can constantly monitor the odorous trends to detect the critical processes that cause odours and adopt all the measures to contain emissions.**



# DETECTION SYSTEM

A champion of technology.



The system is provided with highly sensitive ancillary sensors that measure in real time the presence of odorous substances contained in the air.

The electronic nose simulates the behaviour of the human nose: it records

the variations of signal and measure odours through statistical analysis.

The sampling of the air, both short and long term, takes place into inert bags (Nalophan) via remote control.

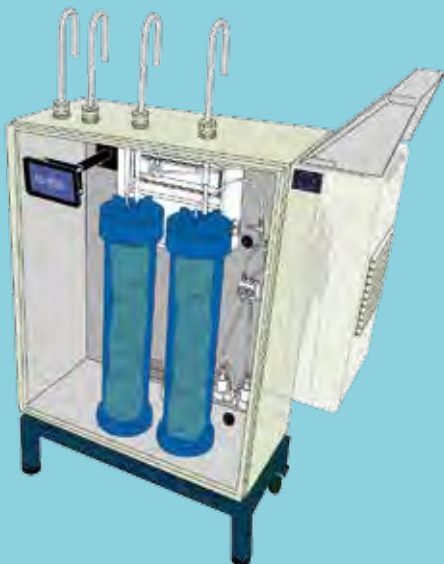

Image for illustrative purposes only.

CONFIGURATION	I° LINE	II° LINE	III° LINE	IV° LINE
<b>TT</b>	Nalophan™	Nalophan™	X	X
<b>FF</b>	Cartridge	Cartridge	X	X
<b>CC</b>	Canister	Canister	X	X
<b>TF</b>	Nalophan™	Cartridge	X	X
<b>TC</b>	Nalophan™	Canister	X	X
<b>FC</b>	Cartridge	Canister	X	X
<b>TFC</b>	Nalophan™	Cartridge	Canister	X
<b>TTF</b>	Nalophan™	Nalophan™	Cartridge	X
<b>FFC</b>	Cartridge	Cartridge	Canister	X
<b>CCF</b>	Canister	Canister	Cartridge	X
<b>CCFF</b>	Canister	Canister	Cartridge	Cartridge

Available sampling lines	Abbreviation
Rigid and opaque vacuum tube for sampling on Nalophan®bag	<b>T</b>
Sampling module on a thermal-chemical desorption cartridge	<b>F</b>
Sampling module on Canister	<b>C</b>



**View  
data sheet**

# ODORPREP<sup>®</sup>

Automated Odor Emission Sampler

[www.odorprep.eu](http://www.odorprep.eu)



ODORPREP IS A PROJECT BY

**LABSERVICE ANALYTICA SRL**

Via Emilia 51/c - 40011 Anzola Emilia (BO)

T. +39 051 732351 - [info@labservice.it](mailto:info@labservice.it)

[www.labservice.it](http://www.labservice.it)



This project has received funding from the European Union's Horizon 2020 research and innovation programme under grant agreement No. 756865



**DOWNLOAD OUR APP**





**ODORPREP<sup>®</sup>**  
Automated **Odor** **Emission** Sampler **v3**



Datasheet

# ODORPREP<sup>®</sup>

Automated Odor Emission Sampler V3

www.odorprep.eu



The integrated system for continuous air quality monitoring and on-demand sampling of olfactory harassments.



OdorPrep<sup>®</sup> V3 is equipped with an integrated control panel and comes with its own dedicated mobile applications for the remote control of the system, allowing the operation of all sample lines, or individually as required. The OdorPrep application is available via Play Store<sup>®</sup>.

3 sampling methods are available.

*Image for illustrative purposes*

## *On-demand odor sampling method to EN13725 (Nalophan<sup>™</sup> bags)*

The sampling line has an adjustable flow valve allowing sampling versatility. Duplicate or individual samples can be taken to allow for maximum flexibility and improved collection of the odorous air. The sampling lines are equipped with a protection system to preserve the sample following collection.

The sampling, storage and transport containers of the sample are rigid and sealed to avoid exposure to direct sunlight (two containers included for each sampling line), in order to minimize any chemical (photo)reactions and diffusion (as foreseen in the standard EN13725). The containers are returned for analysis in an accredited laboratory.

### **Sampling module on Nalophan bag<sup>™</sup>**

Sampling method	Lung principle	Material	Nalophan <sup>™</sup> bag ( <i>not included</i> )
Nominal flow	8.5 l/min.	Collection tube	PVC stiff and opaque
Operating flow	1.2 – 5.6 l/min.	Tube dimension (cm)	82 H x 15 ID x 19 OD
Volumetric capacity	10 l	Weight	Approx. 5 Kg



### *On-demand sampling module on thermal or chemical desorption cartridge*

The sampling line on cartridge (thermal desorption or sorbent tube) includes a high-quality vacuum pump and mass flow controller for ensuring the correct flow rate is maintained and a record of the total sampling volume is provided.

#### **Sampling module on cartridge**

Sampling Solid adsorption support (*not included*)  
Operating flow 20 ml/min. – 1300 ml/min.

---

### *On-demand sampling module on Canister*

The sampling line is equipped with a control unit for the remote opening and closing of the specialist valve, a dedicated digital pressure sensor monitors any vacuum losses while the sampler is operational.

The duration of the sampling depends on the restrictor used. Below are some examples of sampling durations depending on the restrictor and the Canister volume.

Critical orifice diameter of the restrictor vs. flow rate					
Orifice Diameter	Flow Rate Range	Canister Volume / Sampling Time			
(in.)	(mL/min.)	1L	3L	6L	15L
0.0008	0.5–2	24 hr.	48 hr.	125 hr.	—
0.0012	2–4	4 hr.	12 hr.	24 hr.	60 hr.
0.0016	4–8	2 hr.	6 hr.	12 hr.	30 hr.
0.0020	8–15	1 hr.	4 hr.	8 hr.	20 hr.
0.0030	15–30	—	2 hr.	3 hr.	8 hr.
0.0060	30–80	—	—	1.5 hr.	4 hr.
0.0090	80–340	—	—	0.5 hr.	1 hr.

The canister sampling lines are independent. Sampling can be performed on several lines simultaneously or in sequence. The sampling unit is equipped with a temperature control system to allow the correct storage of the samples and the sampling temperature above the dew point, avoiding condensation. At the end of the sampling period a notification is sent to the operators so that collection of the canisters can be arranged.

---

Different configurations available for on-demand sampling are shown below.

**Available sampling lines**

Rigid and opaque vacuum tube for sampling on Nalophan® bag  
 Sampling module on a thermal-chemical desorption cartridge  
 Sampling module on Canister

Abbreviation

T  
 F  
 C

Configuration	I° Line	II° Line	III° Line	IV° Line
TT	Nalophan™	Nalophan™	X	X
FF	Cartridge	Cartridge	X	X
CC	Canister	Canister	X	X
TF	Nalophan™	Cartridge	X	X
TC	Nalophan™	Canister	X	X
FC	Cartridge	Canister	X	X
TFC	Nalophan™	Cartridge	Canister	X
TTF	Nalophan™	Nalophan™	Cartridge	X
FFC	Cartridge	Cartridge	Canister	X
CCF	Canister	Canister	Cartridge	X
CCFF	Canister	Canister	Cartridge	Cartridge

**OdorPrep V3 – On-demand sampling system**

Power supply 220 VAC ; 24 VDC ; 50-60 Hz  
 Dimension (L x H x D) 82 cm x 125 cm x 50 cm (sampling point excluded)  
 Communication 3G / 4G (*SIM card not included*)  
 Protection IP65 – Key box panel lock  
 Weight 100 Kg  
 Transport Cart with 4 swivel and self-locking wheels

**Sampling unit set-up**

Temperature control of the sample storage system.

On-board computer and control panel for manual management of the sampling unit.

OdorPrep® mobile application – Remote management of on-demand sampling and monitoring systems.

OdorAlert mobile application - Collection of reports from qualified receptors and sampling activation.

OdorSens mobile application - Integration of sensors (e.g. MSEM 3200, NETPID, OdorMeteo, Fidas 200) for monitoring the air quality, the meteorological data, the detection of odors and for the activation of the on-demand sampling once thresholds limits are exceeded.

OdorBot - Collection and management of odor signals via Telegram™ and on-demand sampling activation.

## OdorPrep® App. – The status of the monitoring campaign on your smartphone

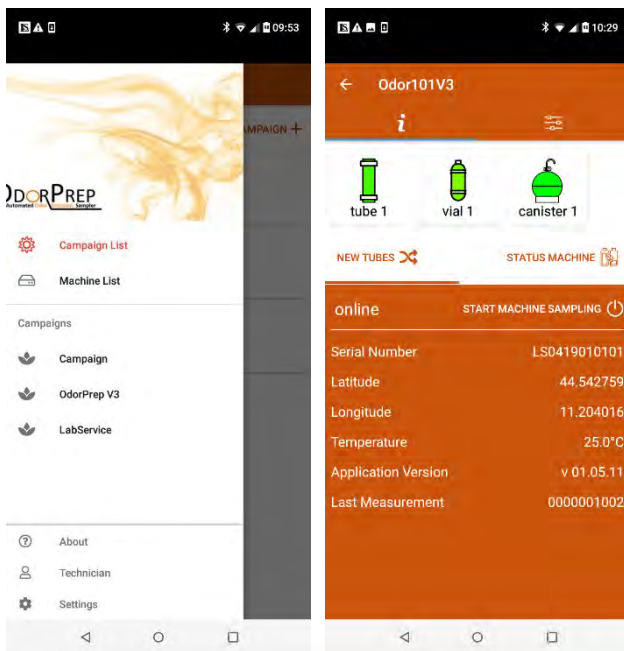

OdorPrep® mobile application can be downloaded for free from the Play Store. The access to the application functions is included with the purchase of the OdorPrep® V3.

The mobile application allows the management of the sampling units, the on-demand sampling on one or more lines, as well as the creation and the management of monitoring campaigns.

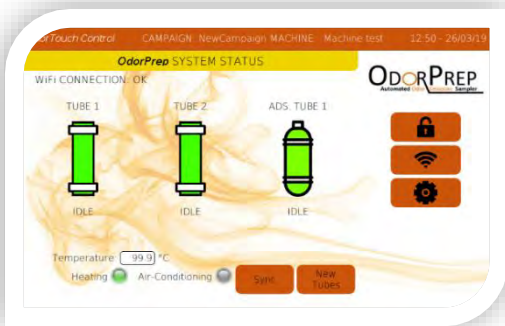

Sampling can be performed manually too. OdorPrep® system may be activated in the field by accessing the on-board computer, equipped with the dedicated management software.

## OdorAlert - Collection of reports via mobile application

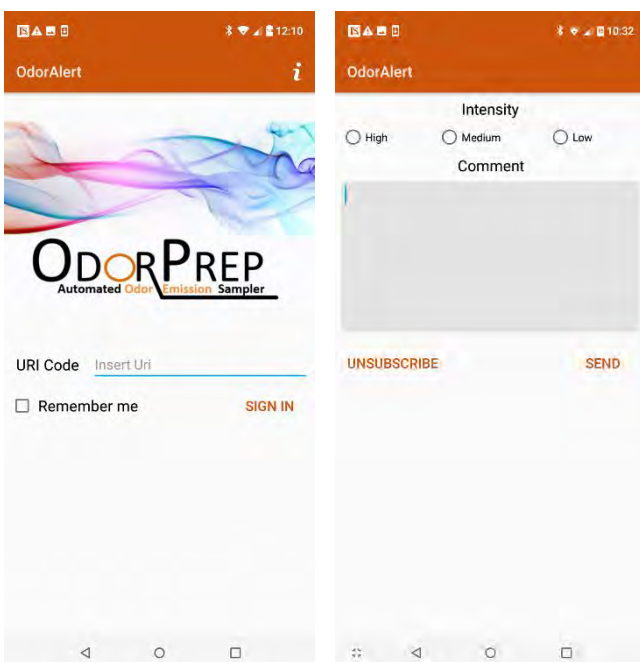

*OdorAlert* is the optional module of the OdorPrep® mobile application that allows to receive and view reports of authorized receptors in real time.

Authorized receptors can send reports by downloading the free *OdorAlert* mobile application, available on Play Store.

Each report contains information about the level of intensity of the perceived odor and any comment by the receptor.

Through the optional OdorAlert module it's possible to activate the threshold limits, after which the system automatically triggers one or more samplers and sends push notifications or e-mails to the operators.

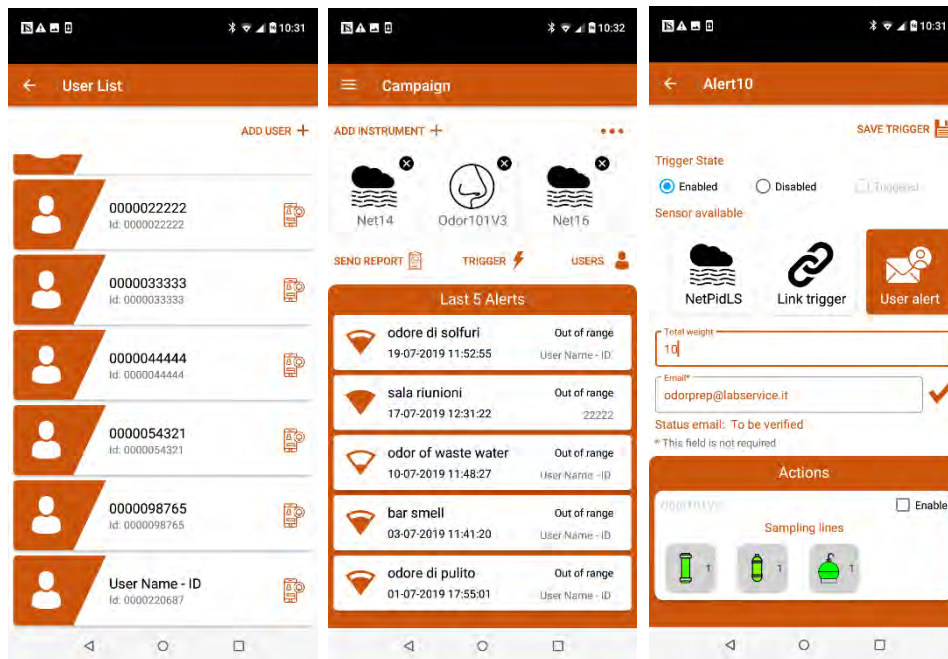

### OdorSens – IT Platform for monitoring air quality and odors in real time

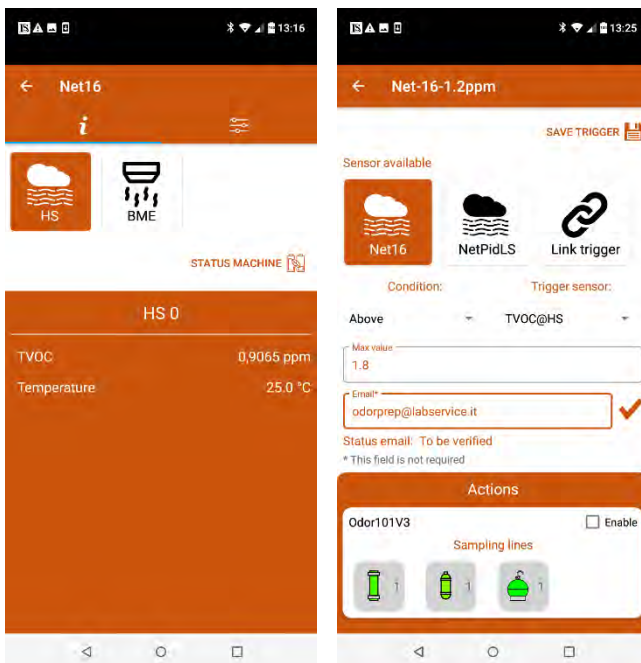

OdorSens is the optional module of the OdorPrep® mobile application that allows real-time display and recording of data coming from sensors and weather stations via the OdorPrep® mobile application.

Where values exceed the concentration limit values or the occurrence of conditions predefined by the operator, the system is able to automatically trigger the OdorPrep®. Type and technical requirements of sensors can be selected depending on the use case.

## OdorPrep® BOT – The collection of reports via instant messaging

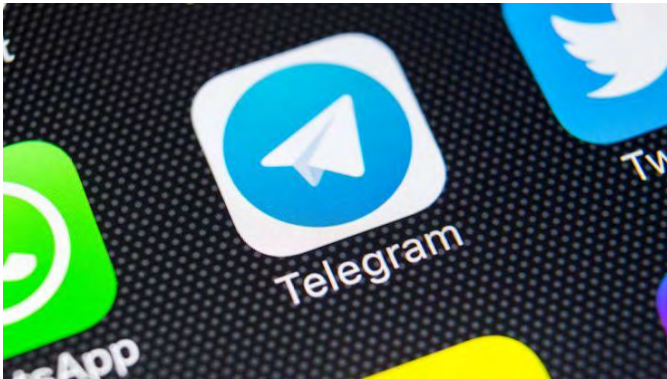

OdorPrep® BOT is a Telegram™ system operated by specific software. The program allows the recording of reports caused by odour nuisance. The BOT is also able to start the on- demand sampling in the event of exceeding a threshold value set by the operator.

Two access mode are available: the identification code and the nickname.

Only users with an identification code will participate in the calculation of the reporting threshold for the start of sampling. Users with nicknames will not participate in the calculation of the threshold and will only be used for statistical purposes.

The system settings are completely customizable and it's possible to assign roles and relevance of alerts for each user. The system automatically generates a daily report of the reports, exportable in Excel format.

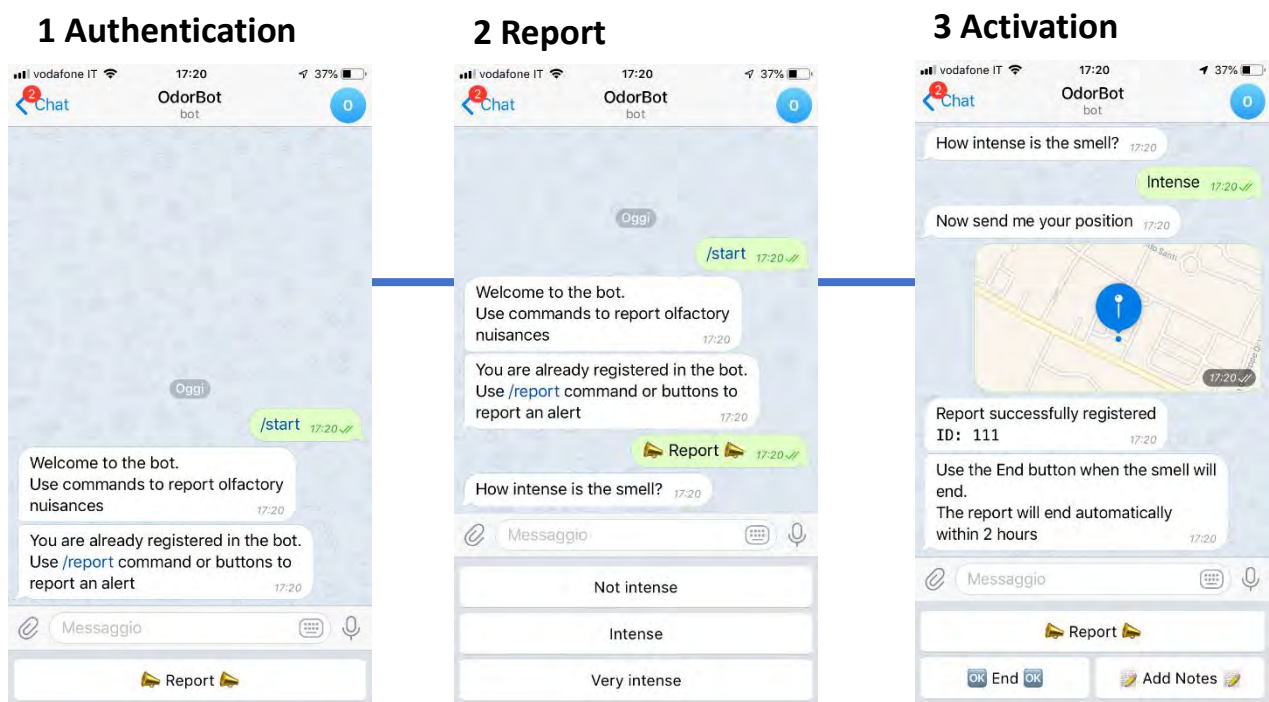

**Lab Service Analytica Srl**

Via Emilia 51/c – 40011 Anzola dell'Emilia (BO)

T. +39 051 732351 – [info@labservice.it](mailto:info@labservice.it)

[www.labservice.it](http://www.labservice.it)

**Appendix E**  
**Sample Event Field Photos**

## Appendix E: Sample Event Field Photos

### Sampling Event 1



Figure E-1. Vacuum chamber and flux chamber on biofilter surface at ZWED





Figure E-2. Sorption tube assembly with flux hood on biofilter surface at ZWED



Figure E-3. Sorption tube placement at ZWED interior



Figure E-4. Vacuum chamber during bag filling



Figure E-5. Carbon filter unit serving biogas bladder at ZWED roof

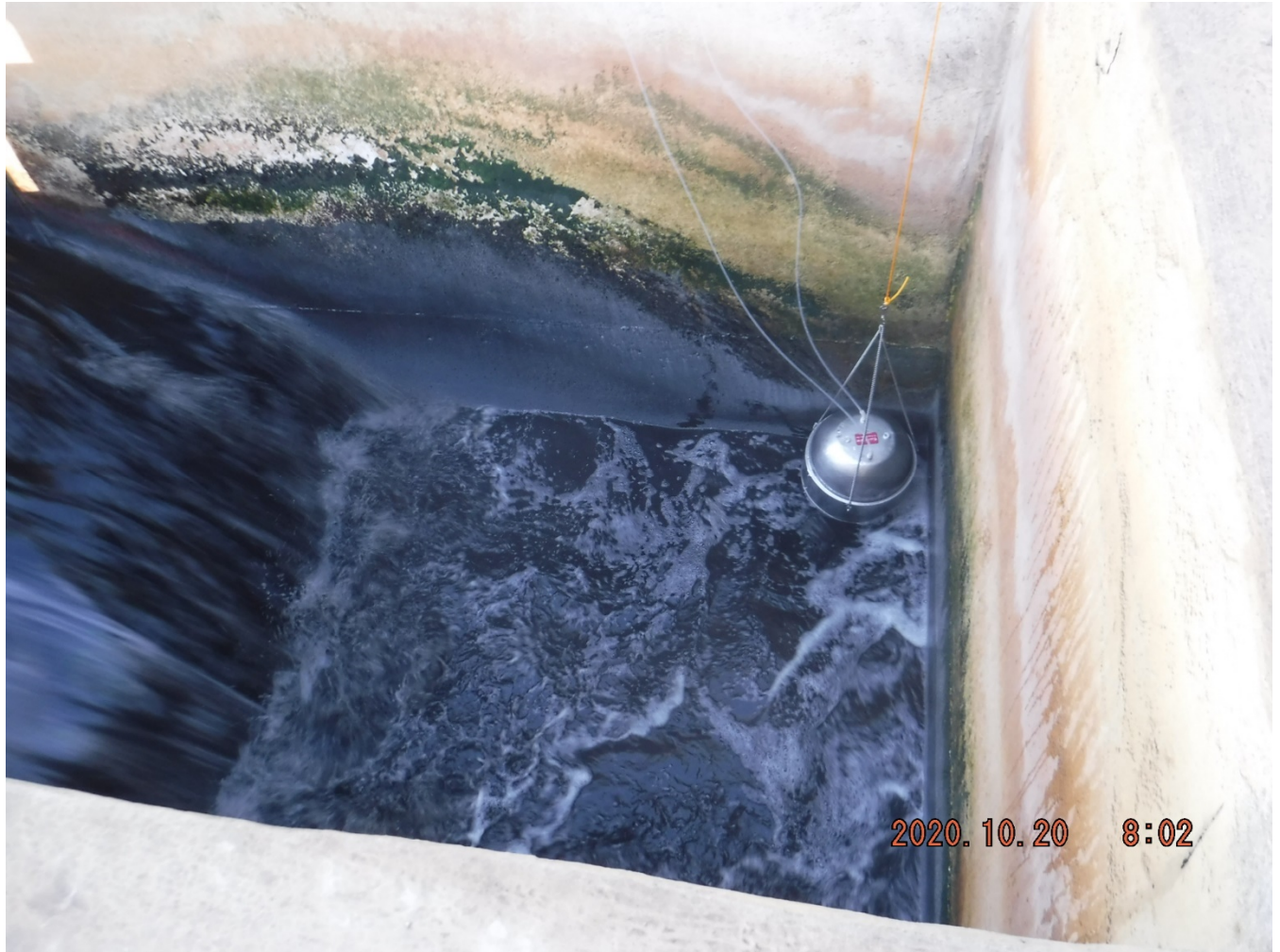

Figure E-6. Flux chamber placed on surface of RWF primary influent channel



Figure E-7. Nitrogen purge gas cylinder at RWF primary influent channel

## Sampling Event 2



Figure E-8. Vacuum chamber for bag sample collection at RWF bioreactors



Figure E-9. Flux hood deployed on surface of RWF bioreactors





Figure E-10. Sorption tube collection with flux chamber at NIRRP working face



Figure E-11. Flux chamber deployed on surface of primary influent channel at RWF

### Sampling Event 3



Figure E-12. Bay estuary culvert



Figure E-13. Vacuum chamber with flux chamber on surface of ZWED biofilter



Figure E-14. Odor log with Mr. Floaty deployed on surface of RWF bioreactor



Figure E-15. Odor log unit deployed within ZWED interior space



Figure E-16. Green ground pile at ZWED

**Appendix F**  
**Parts Per Billion to Mass Loading Conversion Summary**



### Appendix F: ppb to Mass Loading Conversion Summary

**SAMPLE EVENT NO.1: FALL 2020**

molar volume @ 20 degrees C      24.04 EPA standard @ STP      sample pump airflow:  
 gas constant (L\*atm)/(K\*mol)      0.082      bag samples: 2.0 lpm  
 molar volume @ 25 degrees C      24.45      sorption tubes: 1.0 lpm

  = input      Top 30 compounds        = cell contains the Method Reporting Limit; measured concentration fell below this limit

Compound:	MW	ZWED									RWF									NIRRP																					
		ZWED Interior			ZWED Biofilter			Activated Carbon Filter			East Primaries			Bioreactors			Lagoons			Drying Beds			Landfill Working Face			Compost Piles			MRF			Landfill Gas			Cake Stockpile						
		ppb	µg/L	lbs/hour	ppb	µg/L	lbs/hour	ppb	µg/L	lbs/hour	ppb	µg/L	lbs/hour	ppb	µg/L	lbs/hour	ppb	µg/L	lbs/hour	ppb	µg/L	lbs/hour	ppb	µg/L	lbs/hour	ppb	µg/L	lbs/hour	ppb	µg/L	lbs/hour	ppb	µg/L	lbs/hour	ppb	µg/L	lbs/hour	ppb	µg/L	lbs/hour	
sulfur	hydrogen sulfide	34.08	24	0.034	9.00E-09	7.6	0.0108	2.85E-09	16	0.0227	6.00E-09	2.90E+04	41.111	1.09E-05	240	0.3402	9.0E-08	9.6	0.0136	3.6E-09	18	0.0255	6.8E-09	21	0.0298	7.9E-09	16	0.0227	6.00E-09	19	0.0269	7.1E-09	5E+06	6379.4	1.7E-03	10	0.01418	3.8E-09			
	dimethyl disulfide (DMDS)	94.19	7.3	0.0286	7.57E-09	9.5	0.0372	9.85E-09	0	0.0000	0.00E+00	0	0	0.00	15	0.0588	1.6E-08	0	0	0.0E+00	0	0	0.0E+00	0	0	0.0E+00	0	0	0.0E+00	0	0	0.0E+00	300	1.1754	3.1E-07	13	0.05093	1.3E-08			
	methyl mercaptan (MM)	48.11	32	0.064	1.69E-08	7.3	0.0146	3.86E-09	0	0.0000	0.00E+00	1100	2.2014	5.82E-07	690	1.3809	3.7E-07	0	0	0.0E+00	0	0	0.0E+00	0	0	0.0E+00	0	0	0.0E+00	0	0	0.0E+00	35000	70.044	1.9E-05	0	0	0.0E+00			
	dimethyl sulfide (DMS)	62.13	0	0	0.00E+00	22	0.0569	1.50E-08	0	0.0000	0.00E+00	57	0.1473	3.90E-08	51	0.1318	3.5E-08	0	0	0.0E+00	0	0	0.0E+00	0	0	0.0E+00	10	0.0258	6.8E-09	0	0	0.0E+00	37000	95.624	2.5E-05	42	0.10855	2.9E-08			
	carbonyl sulfide (COS)(CS)	60.075	6.3	0.0157	4.17E-09	9.1	0.0227	6.02E-09	0	0.0000	0.00E+00	68	0.1699	4.50E-08	31	0.0775	2.0E-08	0	0	0.0E+00	0	0	0.0E+00	0	0	0.0E+00	0	0	0.0E+00	0	0	0.0E+00	6100	15.244	4.0E-06	24	0.05998	1.6E-08			
carbon disulfide (CS <sub>2</sub> )(CDS)	76.13	7.6	0.0241	6.37E-09	9.5	0.0301	7.96E-09	5.6	0.0177	4.69E-09	71	0.2248	5.95E-08	93	0.2945	7.8E-08	0	0	0.0E+00	0	0	0.0E+00	0	0	0.0E+00	0	0	0.0E+00	0	0	0.0E+00	1900	6.0169	1.6E-06	38	0.12034	3.2E-08				
nitrogen	ammonia	17.03	1	n/a	n/a	8	0.0057	7.50E-10	1	0.0007	9.37E-11	n/a	n/a	n/a	n/a	n/a	n/a	30	0.0213	2.8E-09	0.01	7E-06	9.4E-13	9	0.0064	8.4E-10	0.01	7E-06	9.37E-13	n/a	n/a	n/a	2.5	0.0018	2.3E-10	1	0.00071	9.4E-11			
	trimethyl amine (C <sub>3</sub> H <sub>9</sub> N)	59.11	0	0	0.00E+00	0	0.0000	0.00E+00	n/a	n/a	n/a	n/a	n/a	n/a	n/a	n/a	n/a	n/a	0	0	0	0	0	0	9.4	0.0231	3.1E-09	0	0	0	0	0	0	0	0	0	0	0	0	0	0
VFAs	acetic acid (C <sub>2</sub> H <sub>4</sub> O <sub>2</sub> )(A)	60.05	920	2.2981	3.04E-07	0	0	0.00E+00	n/a	n/a	n/a	n/a	n/a	n/a	n/a	n/a	n/a	0	0	0	0	0	0	240	0.5995	7.9E-08	0	0	0	16	0.04	5.3E-09	390	0.9742	1.3E-07	17	0.04246	5.6E-09			
	butanoic (butyric) acid (B)	88.11	92	0.3372	4.46E-08	0	0	0.00E+00	n/a	n/a	n/a	n/a	n/a	n/a	n/a	n/a	n/a	0	0	0	0	0	0	37	0.1356	1.8E-08	0	0	0	0	0	0	2200	8.0633	1.1E-06	0	0	0			
	propionic acid (P)	74.08	150	0.4622	6.11E-08	0	0	0.00E+00	n/a	n/a	n/a	n/a	n/a	n/a	n/a	n/a	n/a	0	0	0	0	0	0	46	0.1418	1.9E-08	0	0	0	1.4	0.0043	5.7E-10	300	0.9245	1.2E-07	2.3	0.00709	9.4E-10			
	pentanoic (valeric) acid (C <sub>5</sub> H <sub>10</sub> O <sub>2</sub> ) (V)	102.13	16	0.068	8.99E-09	0	0	0.00E+00	n/a	n/a	n/a	n/a	n/a	n/a	n/a	n/a	n/a	0	0	0	0	0	0	3.5	0.0149	2E-09	0	0	0	0	0	0	400	1.6993	2.2E-07	0	0	0			
	isobutyric acid (C <sub>4</sub> H <sub>8</sub> O <sub>2</sub> ) (2-MP)	88.11	10	0.0367	4.85E-09	0	0	0.00E+00	n/a	n/a	n/a	n/a	n/a	n/a	n/a	n/a	n/a	0	0	0	0	0	0	13	0.0476	6.3E-09	0	0	0	0	0	0	140	0.5131	6.8E-08	2.8	0.01026	1.4E-09			
Carbonyl	hexanoic acid (C <sub>6</sub> H <sub>12</sub> O <sub>2</sub> ) (H)	116.16	10	0.0483	6.39E-09	0	0	0.00E+00	n/a	n/a	n/a	n/a	n/a	n/a	n/a	n/a	n/a	0	0	0	0	0	0	6	0.029	3.8E-09	0	0	0	0	0	0	1000	4.8319	6.4E-07	0	0	0			
	acetaldehyde	44.05	260	0.4764	6.30E-08	10	0.0183	2.42E-09	n/a	n/a	n/a	n/a	n/a	n/a	n/a	n/a	n/a	0	0	0	4.6	0.0084	1.1E-09	820	1.5025	2E-07	4.4	0.0081	1.07E-09	7.7	0.0141	1.9E-09	300	0.5497	7.3E-08	5.4	0.00989	1.3E-09			
	formaldehyde (CH <sub>2</sub> O)	30.03	50	0.0625	8.26E-09	7.7	0.0096	1.27E-09	n/a	n/a	n/a	n/a	n/a	n/a	n/a	n/a	n/a	0	0	0	0	0	0	170	0.2124	2.8E-08	0	0	0	4.9	0.0061	8.1E-10	13	0.0162	2.1E-09	2.9	0.00362	4.8E-10			
	propionaldehyde (C <sub>3</sub> H <sub>6</sub> O)	58.08	3.4	0.0082	1.09E-09	0	0	0.00E+00	n/a	n/a	n/a	n/a	n/a	n/a	n/a	n/a	n/a	0	0	0	0	0	0	13	0.0314	4.2E-09	0	0	0	0	0	0	110	0.2658	3.5E-08	0	0	0			
	n-hexaldehyde (C <sub>6</sub> H <sub>12</sub> O)	100	2	0.0083	1.10E-09	0	0	0.00E+00	n/a	n/a	n/a	n/a	n/a	n/a	n/a	n/a	n/a	0	0	0	0.74	0.0031	4.1E-10	3.4	0.0141	1.9E-09	0	0	0	0.42	0.0017	2.3E-10	15	0.0624	8.3E-09	0.43	0.00179	2.4E-10			
	isovaleraldehyde (C <sub>5</sub> H <sub>10</sub> O)	86.13	2	0.0072	9.48E-10	0	0	0.00E+00	n/a	n/a	n/a	n/a	n/a	n/a	n/a	n/a	n/a	0	0	0	0	0	0	5.6	0.0201	2.7E-09	0	0	0	0	0	0	26	0.0932	1.2E-08	0.77	0.00276	3.6E-10			
	butyraldehyde (C <sub>4</sub> H <sub>8</sub> O)	72.11	2.6	0.0078	1.03E-09	0	0	0.00E+00	n/a	n/a	n/a	n/a	n/a	n/a	n/a	n/a	n/a	0	0	0	0	0	0	6.9	0.0207	2.7E-09	0	0	0	0	0	0	140	0.4199	5.6E-08	0.59	0.00177	2.3E-10			
VOCs	benzaldehyde	106.12	0.53	0.0023	3.09E-10	0	0	0.00E+00	n/a	n/a	n/a	n/a	n/a	n/a	n/a	n/a	n/a	0	0	0	0	0	0	2.3	0.0102	1.3E-09	0	0	0	0	0	0	0	0	0	0	0	0	0	0	
	acetone (Ac)	58.08	210	0.5074	6.71E-08	34	0.0821	1.09E-08	0	0	0.00E+00	4.7	0.0114	1.50E-09	5.3	0.0128	1.7E-09	0.99	0.0024	3.2E-10	3.7	0.0089	1.2E-09	1100	2.6576	3.5E-07	1.3	0.0031	4.15E-10	8.4	0.0203	2.7E-09	8200	19.811	2.6E-06	4.7	0.01136	1.5E-09			
	acetonitrile (An)	41.05	58	0.099	1.31E-08	12	0.0205	2.71E-09	0	0	0.00E+00	10	0.0171	2.26E-09	2.8	0.0048	6.3E-10	11	0.0188	2.5E-09	9.7	0.0166	2.2E-09	78	0.1332	1.8E-08	0.42	0.0007	9.49E-11	28	0.0478	6.3E-09	710	1.2124	1.6E-07	30	0.05123	6.8E-09			
	benzene (Bz)	78.11	0.49	0.0016	2.11E-10	0.89	0.0029	3.83E-10	0	0	0.00E+00	1.3	0.0042	5.59E-10	1	0.0032	4.3E-10	0.14	0.0005	6E-11	0.039	0.0001	1.7E-11	1.2	0.0039	5.2E-10	0.25	0.0008	1.07E-10	0.77	0.0025	3.3E-10	970	3.1517	4.2E-07	0.48	0.00156	2.1E-10			
	toluene (T)	92.15	18	0.069	9.13E-09	5.6	0.0215	2.84E-09	0	0	0.00E+00	20	0.0767	1.01E-08	25	0.0958	1.3E-08	0.57	0.0022	2.9E-10	1.2	0.0046	6.1E-10	56	0.2147	2.8E-08	1.1	0.0042	5.58E-10	23	0.0882	1.2E-08	1700	6.5164	8.6E-07	1.5	0.00575	7.6E-10			
	ethyl benzene (Ebz)	106.17	1.5	0.0066	8.76E-10	1.4	0.0062	8.18E-10	0	0	0.00E+00	3	0.0132	1.75E-09	2.1	0.0093	1.2E-09	0.04	0.0002	2.3E-11	0.12	0.0005	7E-11	15	0.0662	8.8E-09	0.17	0.0008	9.93E-11	2.8	0.0124	1.6E-09	0	0	0	0.16	0.00071	9.3E-11			
	ethanol (E)	46.07	6400	12.265	1.62E-06	11	0.0211	2.79E-09	0	0	0.00E+00	29	0.0556	7.35E-09	11	0.0211	2.8E-09	3.1	0.0059	7.9E-10	3.6	0.0069	9.1E-10	4700	9.007	1.2E-06	2.5	0.0048	6.34E-10	19	0.0364	4.8E-09	20000	38.328	5.1E-06	17	0.03258	4.3E-09			
	styrene (St)	104.16	1.7	0.0074	9.74E-10	0.69	0.003	3.95E-10	0	0	0.00E+00	0.4	0.0017	2.29E-10	0.3	0.0013	1.7E-10	0	0	0	0.061	0.0003	3.5E-11	12	0.052	6.9E-09	0.34	0.0015	1.95E-10	2.6	0.0113	1.5E-09	0	0	0	0.24	0.00104	1.4E-10			
	m,p-Xylenes (m,p-X)	106.97	4.7	0.0209	2.77E-09	7.4	0.0329	4.36E-09	0	0	0.00E+00	3.8	0.0169	2.24E-09	2.3	0.0102	1.4E-09	0.088	0.0004	5.2E-11	0.36	0.0016	2.1E-10	54	0.2403	3.2E-08	0.47	0.0021	2.77E-10	5.7	0.0254	3.4E-09	0	0	0	0.69	0.00307	4.1E-10			
	o-Xylene (o-Xy)	106.17	1.6	0.0071	9.35E-10	2.7	0.009	1.27E-09	0	0	0.00E+00	1.6	0.0071	9.35E-10	0.95	0.0042	5.5E-10	0	0	0	0.14	0.0006	8.2E-11	21	0.0927	1.2E-08	0.17	0.0008	9.93E-11	1.9	0.0084	1.1E-09	0	0	0	0.24	0.00106	1.4E-10			

**Notes:**  
 n/a = not available. Analysis not performed for this specific source.  
 Zero (0) value indicates result is below lower detection limit for specific analysis.

**SAMPLE EVENT NO.3: SPRING 2021**

molar volume @ 20 degrees C  
gas constant  
molar volume @ 25 degrees C

24.04 EPA standard @ STP  
0.082 (L\*atm)/(K\*mol)  
24.45

sample pump airflow:  
bag samples: 2.0 lpm  
sorption tubes: 1.0 lpm

  = input

Top 30 compounds

  = cell contains the Method Reporting Limit; measured concentration fell below this limit

Compound:	MW	ZWED						RWF									NIRRP												
		ZWED Interior			ZWED Biofilter			East Primaries			Bioreactors Mixing Zone			Bioreactors Aerobic Zone			Lagoons			Landfill Working Face			Compost Piles			Landfill Gas			
		ppb	µg/L	lbs/hour	ppb	µg/L	lbs/hour	ppb	µg/L	lbs/hour	ppb	µg/L	lbs/hour	ppb	µg/L	lbs/hour	ppb	µg/L	lbs/hour	ppb	µg/L	lbs/hour	ppb	µg/L	lbs/hour	ppb	µg/L	lbs/hour	
sulfur	hydrogen sulfide	34.08	8.3	0.0118	3.11E-09	0	0	0.00E+00	770	1.0916	2.89E-07	39	0	0.0E+00	8.8	0.0125	3.30E-09	n/a	n/a	n/a	n/a	n/a	n/a	n/a	n/a	n/a	350000	496.17	1.31E-04
	dimethyl disulfide	94.19	0	0	0.00E+00	0	0	0.00E+00	9.3	0.0364	9.64E-09	8.3	0	0.0E+00	0	0	0.00E+00	n/a	n/a	n/a	n/a	n/a	n/a	n/a	n/a	n/a	0	0	0.00E+00
	methyl mercaptan	48.11	0	0	0.00E+00	0	0	0.00E+00	1100	2.2014	5.82E-07	1100	0	0.0E+00	0	0	0.00E+00	n/a	n/a	n/a	n/a	n/a	n/a	n/a	n/a	n/a	2500	5.0031	1.32E-06
	dimethyl sulfide	62.13	0	0	0.00E+00	22	0.0569	1.50E-08	410	1.0596	2.80E-07	230	1E-10	3.8E-17	11	0.0284	7.52E-09	n/a	n/a	n/a	n/a	n/a	n/a	n/a	n/a	n/a	2000	5.1689	1.37E-06
	carbonyl sulfide (COS)	60.075	0	0	0.00E+00	0	0	0.00E+00	470	1.1745	3.11E-07	34	0	0.0E+00	0	0	0.00E+00	n/a	n/a	n/a	n/a	n/a	n/a	n/a	n/a	n/a	690	1.7243	4.56E-07
	carbon disulfide (CS <sub>2</sub> )	76.13	3.6	0.0114	3.02E-09	0	0	0.00E+00	510	1.6151	4.27E-07	73	0	0.0E+00	0	0	0.00E+00	n/a	n/a	n/a	n/a	n/a	n/a	n/a	n/a	n/a	190	0.6017	1.59E-07
nitrogen	ammonia	17.03	n/a	n/a	n/a	n/a	n/a	n/a	n/a	n/a	n/a	n/a	n/a	n/a	n/a	n/a	n/a	n/a	n/a	n/a	n/a	n/a	n/a	n/a	n/a	n/a	n/a	n/a	n/a
	trimethyl amine (C <sub>3</sub> H <sub>9</sub> N)	59.11	n/a	n/a	n/a	n/a	n/a	n/a	n/a	n/a	n/a	n/a	n/a	n/a	n/a	n/a	n/a	n/a	n/a	n/a	n/a	n/a	n/a	n/a	n/a	n/a	n/a	n/a	n/a
VFAs	acetic acid (C <sub>2</sub> H <sub>4</sub> O <sub>2</sub> )	60.05	n/a	n/a	n/a	n/a	n/a	n/a	n/a	n/a	n/a	n/a	n/a	n/a	n/a	n/a	n/a	n/a	n/a	n/a	n/a	n/a	n/a	n/a	n/a	n/a	n/a	n/a	n/a
	butanoic (butyric) acid	88.11	n/a	n/a	n/a	n/a	n/a	n/a	n/a	n/a	n/a	n/a	n/a	n/a	n/a	n/a	n/a	n/a	n/a	n/a	n/a	n/a	n/a	n/a	n/a	n/a	n/a	n/a	n/a
	propionic acid	74.08	n/a	n/a	n/a	n/a	n/a	n/a	n/a	n/a	n/a	n/a	n/a	n/a	n/a	n/a	n/a	n/a	n/a	n/a	n/a	n/a	n/a	n/a	n/a	n/a	n/a	n/a	n/a
	pentanoic (valeric) acid (C <sub>5</sub> H <sub>10</sub> O <sub>2</sub> )	102.13	n/a	n/a	n/a	n/a	n/a	n/a	n/a	n/a	n/a	n/a	n/a	n/a	n/a	n/a	n/a	n/a	n/a	n/a	n/a	n/a	n/a	n/a	n/a	n/a	n/a	n/a	n/a
	isobutyric acid (C <sub>4</sub> H <sub>8</sub> O <sub>2</sub> )	88.11	n/a	n/a	n/a	n/a	n/a	n/a	n/a	n/a	n/a	n/a	n/a	n/a	n/a	n/a	n/a	n/a	n/a	n/a	n/a	n/a	n/a	n/a	n/a	n/a	n/a	n/a	n/a
	hexanoic acid (C <sub>6</sub> H <sub>12</sub> O <sub>2</sub> )	116.16	n/a	n/a	n/a	n/a	n/a	n/a	n/a	n/a	n/a	n/a	n/a	n/a	n/a	n/a	n/a	n/a	n/a	n/a	n/a	n/a	n/a	n/a	n/a	n/a	n/a	n/a	n/a
Carbonyl	acetaldehyde	44.05	13	0.0238	3.15E-09	1.2	0.0022	2.91E-10	n/a	n/a	n/a	5	0.0092	1.21E-09	0.73	0.0013	1.77E-10	n/a	n/a	n/a	0	0	0.00E+00	84	0.1539	2.04E-08	440	0.8062	1.07E-07
	formaldehyde (CH <sub>2</sub> O)	30.03	25	0.0312	4.13E-09	0	0	0.00E+00	n/a	n/a	n/a	1	0.0012	1.65E-10	0.88	0.0011	1.45E-10	n/a	n/a	n/a	0	0	0.00E+00	40	0.05	6.61E-09	0	0	0.00E+00
	propionaldehyde (C <sub>3</sub> H <sub>6</sub> O)	58.08	16	0.0387	5.11E-09	31	0.0749	9.91E-09	n/a	n/a	n/a	8.8	0.0213	2.81E-09	35	0.0846	1.12E-08	n/a	n/a	n/a	5.3	0.0128	1.69E-09	3.6	0.0087	1.15E-09	210	0.5074	6.71E-08
	n-hexaldehyde (C <sub>6</sub> H <sub>12</sub> O)	100	2.6	0.0108	1.43E-09	0	0	0.00E+00	n/a	n/a	n/a	0	0	0.0E+00	0	0	0.00E+00	n/a	n/a	n/a	3.4	0.0141	1.87E-09	6.9	0.0287	3.80E-09	12	0.0499	6.60E-09
	isovaleraldehyde (C <sub>5</sub> H <sub>10</sub> O)	86.13	2.6	0.0093	1.23E-09	0	0	0.00E+00	n/a	n/a	n/a	0	0	0.0E+00	0	0	0.00E+00	n/a	n/a	n/a	3.7	0.0133	1.75E-09	13	0.0466	6.16E-09	15	0.0537	7.11E-09
	butyraldehyde (C <sub>4</sub> H <sub>8</sub> O)	72.11	2.3	0.0069	9.13E-10	0	0	0.00E+00	n/a	n/a	n/a	0	0	0.0E+00	0	0	0.00E+00	n/a	n/a	n/a	5.4	0.0162	2.14E-09	6.9	0.0207	2.74E-09	220	0.6599	8.73E-08
	benzaldehyde	106.12	0.31	0.0014	1.81E-10	0	0	0.00E+00	n/a	n/a	n/a	0	0	0.0E+00	0	0	0.00E+00	n/a	n/a	n/a	3.7	0.0163	2.16E-09	5.8	0.0256	3.39E-09	74	0.3267	4.32E-08
VOCs	acetone	58.08	n/a	n/a	n/a	n/a	n/a	n/a	n/a	n/a	n/a	n/a	n/a	n/a	n/a	n/a	n/a	n/a	n/a	n/a	n/a	n/a	n/a	n/a	n/a	n/a	n/a	n/a	n/a
	acetonitrile	41.05	8.5	0.0145	1.92E-09	20	0.0342	4.52E-09	n/a	n/a	n/a	2.4	0.0041	5.42E-10	2.6	0.0044	5.87E-10	n/a	n/a	n/a	2.6	0.0044	5.87E-10	2.6	0.0044	5.87E-10	500	0.8538	1.13E-07
	benzene	78.11	1.9	0.0062	8.17E-10	1.9	0.0062	8.17E-10	n/a	n/a	n/a	n/a	n/a	n/a	1.9	0.0062	8.17E-10	1.8	0.0058	7.74E-10	1.9	0.0062	8.17E-10	1.9	0.0062	8.17E-10	190	0.6173	8.17E-08
	toluene	92.15	14	0.0537	7.10E-09	1.6	0.0061	8.11E-10	n/a	n/a	n/a	15	0.0575	7.61E-09	1.6	0.0061	8.11E-10	n/a	n/a	n/a	1.7	0.0065	8.62E-10	2.3	0.0088	1.17E-09	570	2.1849	2.89E-07
	ethyl benzene	106.17	2.7	0.0119	1.58E-09	1.4	0.0062	8.18E-10	n/a	n/a	n/a	1.3	0.0057	7.59E-10	1.4	0.0062	8.18E-10	n/a	n/a	n/a	1.4	0.0062	8.18E-10	3.5	0.0155	2.04E-09	470	2.0757	2.75E-07
	ethanol	46.07	3.3	0.0063	8.37E-10	580	1.1115	1.47E-07	0	0	0.00E+00	2.1	0.004	5.32E-10	3.3	0.0063	8.37E-10	n/a	n/a	n/a	350	0.6707	8.87E-08	4.5	0.0086	1.14E-09	130	0.2491	3.30E-08
	styrene	104.16	1.8	0.0078	1.03E-09	1.5	0.0065	8.60E-10	n/a	n/a	n/a	1.4	0.0061	8.02E-10	1.4	0.0061	8.02E-10	n/a	n/a	n/a	1.4	0.0061	8.02E-10	5.5	0.0238	3.15E-09	190	0.8232	1.09E-07
	m,p-Xylenes	106.97	10	0.0445	5.89E-09	5	0.0222	2.94E-09	n/a	n/a	n/a	1.3	0.0058	7.65E-10	1.4	0.0062	8.24E-10	n/a	n/a	n/a	3.4	0.0151	2.00E-09	14	0.0623	8.24E-09	740	3.2928	4.36E-07
	o-Xylene	106.17	2.5	0.011	1.46E-09	4.1	0.0181	2.40E-09	n/a	n/a	n/a	1.3	0.0057	7.59E-10	1.4	0.0062	8.18E-10	n/a	n/a	n/a	1.4	0.0062	8.18E-10	5.4	0.0238	3.15E-09	550	2.429	3.21E-07

**Notes:**

n/a = not available. Analysis not performed for this specific source.

Zero (0) value indicates result is below lower detection limit for specific analysis.